



BEYOND **Solutions**





pinko



pinko



side

4 legs

4 legs with castors

swivel

folding bench
bench

pinko showing

features



trolley
available



Son assise ample et confortable ainsi que la multitude d'options et de versions de châssis et de composants proposés, lui permettent d'être utilisée dans un **environnement Bureau et Éducatif**.

Mais encore, le **banc avec une assise rabattable** enrichit un assortiment déjà varié et complet, en faisant de **Pinko** un modèle parfait pour tout **environnement de réception de public**.

*Con su asiento, amplio y confortable, y un número elevado de opciones y versiones, es ideal para todos los usos en el **ambiente de la oficina y educativo***

*Todavía hay más, la **bancada con asiento abatible** completa un surtido variado y completo, por lo que **Pinko** se adapta también al **ambiente de la colectividad**.*

pinko

4-legs

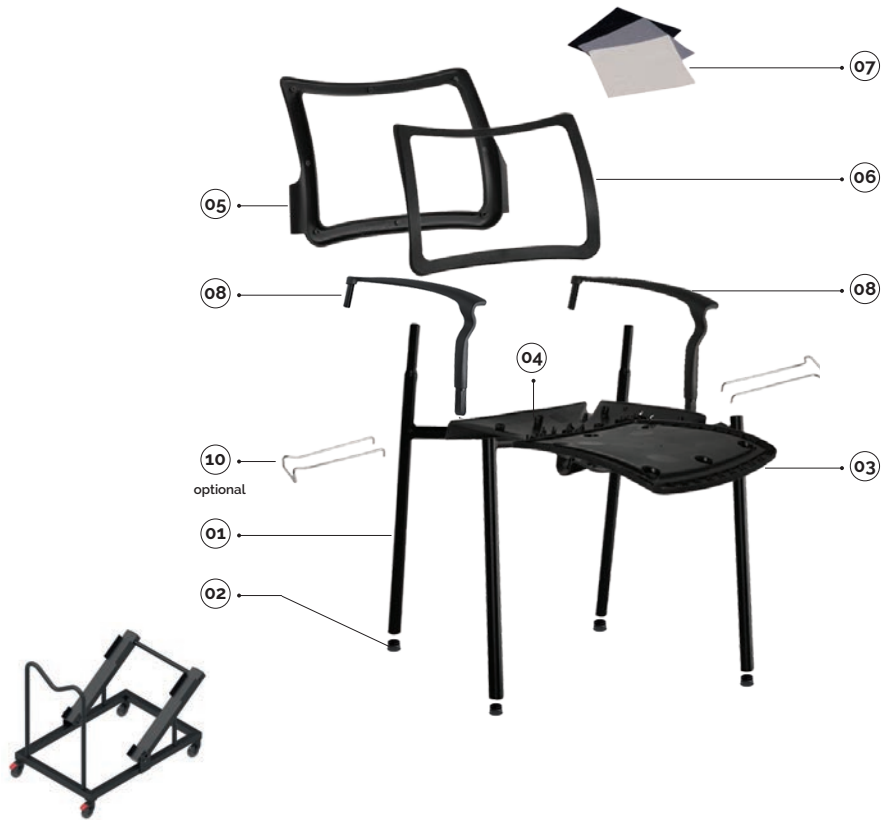

plastic colours

- bleu/azul ral5002
- noir/negro
- gris/gris ral7035

pinko-chariot porte-chaises avec accessoires pinko-carro para sillas con accesorios

code	finishing	q.kit
110803-340	● noir/negro	x1

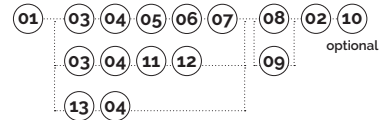

main component sizes

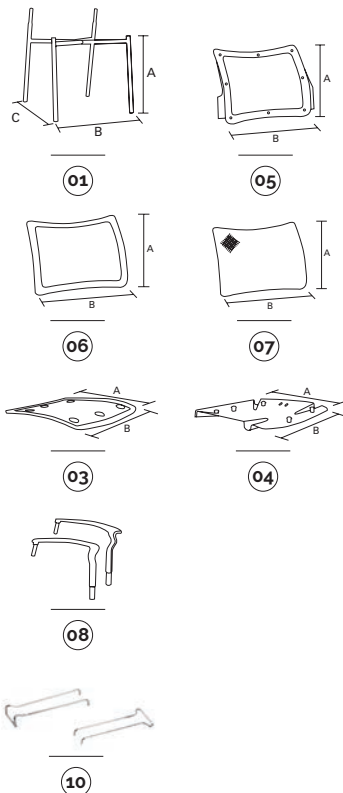

optionals

01 pinko-châssis quatre pieds fixe pour accoudoirs sans embouts pinko-estructura cuatro patas fija para brazos sin tapones

code	finishing	q.kit	q.pack	a	b	c	kg.x1	vol.x1
112603-040	● noir/negro	x1	80	450	530	530	3,20	mc. 0.035
112604-040	● gris/gris	x1	80	450	530	530	3,20	mc. 0.035
112610-040	● chromé/cromado	x1	80	450	530	530	3,20	mc. 0.035

02 pack embouts tête sphérique 025 paquete de tacos con cabeza esférica d.25

code	finishing	q.kit	q.pack
137003-075	● noir/negro	x4	120

03 pinko-siège interne (habillable) pinko-asiento interno (tapizable)

code	finishing	q.kit	q.pack	a	b	kg.x1	vol.x1
132203-025	● noir/negro	x1	10	465	470	0,73	mc. 0.006

04 pinko-siège externe de plastique pinko-asiento externo de plástico

code	finishing	q.kit	q.pack	a	b	kg.x1	vol.x1
132203-026	● noir/negro	x1	20	465	470	0,62	mc. 0.007

05 pinko-châssis dossier en plastique pour treillis (portant) + 2 embouts dossier + 2 embouts siège pinko-estructura respaldo de plástico para malla (portante) + 2 tapones respaldo + 2 tapones asiento

code	finishing	q.kit	q.pack	a	b	kg.x1	vol.x1
132103-027	● noir/negro	x2	20	345	495	0,50	mc. 0.0045

06 pinko-cadre dossier en plastique pour treillis pinko-marco respaldo de plástico para malla

code	finishing	q.kit	q.pack	a	b	kg.x1	vol.x1
132103-028	● noir/negro	x1	10	345	495	0,35	mc. 0.0057

07 pinko-treillis pour dossier pinko-malla para respaldo

code	finishing	q.kit	q.pack	a	b	kg.x1	vol.x1
132105-501	○ blanc/blanco	x1	25	460	520	0,14	mc. 0.0057
132103-501	● noir/negro	x1	25	460	520	0,14	mc. 0.0057
132104-501	● gris/gris	x1	25	460	520	0,14	mc. 0.0057

08 pinko-paire d'accoudoirs droit-gauche en plastique pinko-pareja brazos derecho-izquierdo de plástico

code	finishing	q.kit	q.pack	kg.x1	vol.x1
131703-050	● noir/negro	x1	10	0,66	mc. 0.0037

10 pinko/logan-attelage latéral mâle+female chromé pinko/logan-enganche lateral macho+hembra cromado

code	finishing	q.kit	q.pack	kg.x1	vol.x1
113410-100	● chromé/cromado	x1	100	0,13	mc. 0.0004

pinko

4-legs/tablet accessories

main component sizes



09



09 pinko-paire d'accoudoirs en plastique avec crochet tablette droit

pinko-pareja brazos de plástico con gancho pala derecho

code	finishing	q.kit	q.pack	kg.x1	vol.x1
131703-051	● noir/negro	x1	10	0,70	mc. 0,0037

TLT
tablet



TLT2
tablet



TLT3
tablet



BEAN
tablet



TL02
tablet



SPT2
mechanism tablet



SPTA
mechanism antipanic



for writing tablet options, see page 192/193

4-legs/seat and backrest options

main component sizes

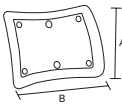

11



11 pinko-dossier interne (habillable)

pinko-respaldo interno (tapizable)

code	finishing	q.kit	q.pack	a	b	kg.x1	vol.x1
132103-025	● noir/negro	x1	20	350	495	0,62	mc. 0,009

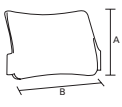

12

12 pinko-dossier externe en plastique + 2 embouts dossier + 2 embouts siège

pinko-respaldo externo de plástico + 2 tapones respaldo + 2 tapones asiento

code	finishing	q.kit	q.pack	a	b	kg.x1	vol.x1
132103-026	● noir/negro	x1	10	350	495	0,25	mc. 0,0045

and 03 04

main component sizes

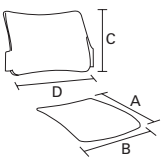

13



13 pinko-siège/dossier en plastique coloré + 2 embouts dossier + 2 embouts siège

pinko-asiento/respaldo de plástico de color base + 2 tapones respaldo + 2 tapones asiento

code	finishing	q.kit	q.pack	a	b	c	d	kg.x1	vol.x1
134015-108	● bleu/azul ral 5002	x1	10	470	465	350	495	1,78	mc. 0,014
134003-108	● noir/negro	x1	10	470	465	350	495	1,78	mc. 0,014
134004-109	● gris/gris ral 7035	x1	10	470	465	350	495	1,78	mc. 0,014

and 04

pinko

4-legs for castors



plastic colours

- bleu/azul ral5002
- noir/negro
- gris/gris ral7035

main component sizes

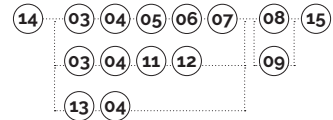
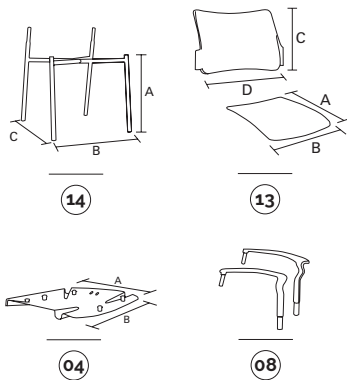

14 pinko-châssis quatre pieds pour roulettes + 4 engrenages pour roulettes pinko-estructura cuatro patas para ruedas + 4 adaptadores para ruedas

code	finishing	q.kit	q.pack	a	b	c	kg.x1	vol.x1
112603-041	● noir/negro	x1	80	390	530	530	3,20	mc. 0.035
112604-041	● gris/gris	x1	80	390	530	530	3,20	mc. 0.035
112610-041	● chromé/cromado	x1	80	390	530	530	3,20	mc. 0.035

15 double roulette ø50 en desmopan tige montée rueda doble d. 50 de desmopan con perno montado

code	finishing	q.kit
134403-003	● noir/negro	x4

13 pinko-siège/dossier en plastique coloré + 2 embouts dossier + 2 embouts siège pinko-asiento/respaldo de plástico de color base + 2 tapones respaldo + 2 tapones asiento

code	finishing	q.kit	q.pack	a	b	c	d	kg.x1	vol.x1
134015-108	● bleu/azul ral 5002	x1	10	470	465	350	495	1,78	mc. 0.014
134003-108	● noir/negro	x1	10	470	465	350	495	1,78	mc. 0.014
134004-109	● gris/gris ral 7035	x1	10	470	465	350	495	1,78	mc. 0.014

04 pinko-siège externe de plastique pinko-asiento externo de plástico

code	finishing	q.kit	q.pack	a	b	kg.x1	vol.x1
132203-026	● noir/negro	x1	20	465	470	0,62	mc. 0.007

08 pinko-paire d'accoudoirs droit-gauche en plastique pinko-pareja brazos derecho-izquierdo de plástico

code	finishing	q.kit	q.pack	kg.x1	vol.x1
131703-050	● noir/negro	x1	10	0,66	mc. 0.0037



pinko-chariot porte-chaises avec accessoires pinko-carro para sillas con accesorios

code	finishing	q.kit
110803-340	● noir/negro	x1

pinko

4-legs for castors/tablet accessories

main component sizes



09



09 pinko-paire d'accoudoirs en plastique avec crochet tablette droit pinko-pareja brazos de plástico con gancho pala derecho

code	finishing	q.kit	q.pack	kg.x1	vol.x1
131703-051	● noir/negro	x1	10	0,70	mc. 0,0037

TLT
tablet

TLT2
tablet

TLT3
tablet

BEAN
tablet

TL02
tablet

SPT2
mechanism tablet

SPTA
mechanism antipanic



for writing tablet options, see page 192/193

4-legs/seat and backrest options

main component sizes

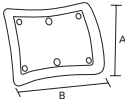

11

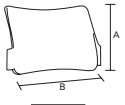

12



11 pinko-dossier interne (habillable) pinko-respaldo interno (tapizable)

code	finishing	q.kit	q.pack	a	b	kg.x1	vol.x1
132103-025	● noir/negro	x1	20	350	495	0,62	mc. 0,009

12 pinko-dossier externe en plastique + 2 embouts dossier + 2 embouts siège pinko-respaldo externo de plástico + 2 tapones respaldo + 2 tapones asiento

code	finishing	q.kit	q.pack	a	b	kg.x1	vol.x1
132103-026	● noir/negro	x1	10	350	495	0,25	mc. 0,0045

and 03 04

main component sizes

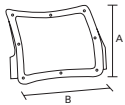

05

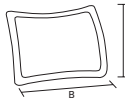

06

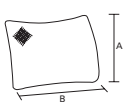

07



05 pinko-châssis dossier en plastique pour treillis (portant) + 2 embouts dossier + 2 embouts siège pinko-estructura respaldo de plástico para malla (portante) + 2 tapones respaldo + 2 tapones asiento

code	finishing	q.kit	q.pack	a	b	kg.x1	vol.x1
132103-027	● noir/negro	x2	20	345	495	0,50	mc. 0,0045

06 pinko-cadre dossier en plastique pour treillis pinko-marco respaldo de plástico para malla

code	finishing	q.kit	q.pack	a	b	kg.x1	vol.x1
132103-028	● noir/negro	x1	10	345	495	0,35	mc. 0,0057

07 pinko-treillis pour dossier pinko-malla para respaldo

code	finishing	q.kit	q.pack	a	b	kg.x1	vol.x1
132105-501	○ blanc/blanco	x1	25	460	520	0,14	mc. 0,0057
132103-501	● noir/negro	x1	25	460	520	0,14	mc. 0,0057
132104-501	● gris/gris	x1	25	460	520	0,14	mc. 0,0057

and 03 04

pinko

slide



plastic colours

- bleu/azul ral5002
- noir/negro
- gris/gris ral7035

main component sizes

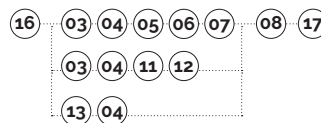
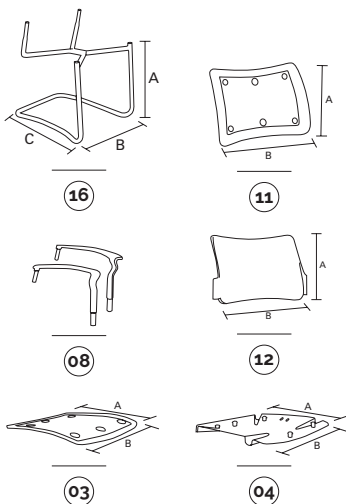

16 pinko-base coulissante en tube asform ø25 embouts exclus
pinko-base patin tubular asform d. 25 tapones excluidos

code	finishing	q.kit	q.pack	a	b	c	kg.x1	vol.x1
110503-093	● noir/negro	x1	40	450	550	550	4,60	mc. 0,06
110504-093	● gris/gris	x1	40	450	550	550	4,60	mc. 0,06
110510-093	● chromé/cromado	x1	40	450	550	550	4,60	mc. 0,06

17 pare-chocs tête bombée ø18
tope cabeza convexa d.18

code	finishing	q.kit
134403-101	● nero/black	x4

03 pinko-siège interne (habillable)
pinko-asiento interno (tapizable)

code	finishing	q.kit	q.pack	a	b	kg.x1	vol.x1
132203-025	● noir/negro	x1	10	465	470	0,73	mc. 0,006

04 pinko-siège externe de plastique
pinko-asiento externo de plástico

code	finishing	q.kit	q.pack	a	b	kg.x1	vol.x1
132203-026	● noir/negro	x1	20	465	470	0,62	mc. 0,007

11 pinko-dossier interne (habillable)
pinko-respaldo interno (tapizable)

code	finishing	q.kit	q.pack	a	b	kg.x1	vol.x1
132103-025	● noir/negro	x1	20	350	495	0,62	mc. 0,009

12 pinko-dossier externe en plastique + 2 embouts dossier + 2 embouts siège
pinko-respaldo externo de plástico + 2 tapones respaldo + 2 tapones asiento

code	finishing	q.kit	q.pack	a	b	kg.x1	vol.x1
132103-026	● noir/negro	x1	10	350	495	0,25	mc. 0,0045

08 pinko-paire d'accoudoirs droit-gauche en plastique
pinko-pareja brazos derecho-izquierdo de plástico

code	finishing	q.kit	q.pack	kg.x1	vol.x1
131703-050	● noir/negro	x1	10	0,66	mc. 0,0037

pinko

slide/seat and backrest options

main component sizes

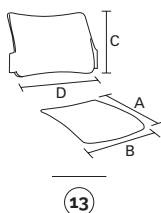

13 pinko-siège/dossier en plastique coloré + 2 embouts dossier + 2 embouts siège
pinko-asiento/respaldo de plástico de color base + 2 tapones respaldo + 2 tapones asiento

code	finishing	q.kit	q.pack	a	b	c	d	kg.x1	vol.x1
134015-108	● bleu/azul ral 5002	x1	10	470	465	350	495	1,78	mc. 0.014
134003-108	● noir/negro	x1	10	470	465	350	495	1,78	mc. 0.014
134004-109	● gris/gris ral 7035	x1	10	470	465	350	495	1,78	mc. 0.014

and **04**

main component sizes

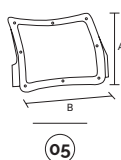

05 pinko-châssis dossier en plastique pour treillis (portant) + 2 embouts dossier + 2 embouts siège
pinko-estructura respaldo de plástico para malla (portante) + 2 tapones respaldo + 2 tapones asiento

code	finishing	q.kit	q.pack	a	b	kg.x1	vol.x1
132103-027	● noir/negro	x2	20	345	495	0,50	mc. 0.0045

06 pinko-cadre dossier en plastique pour treillis
pinko-marco respaldo de plástico para malla

code	finishing	q.kit	q.pack	a	b	kg.x1	vol.x1
132103-028	● noir/negro	x1	10	345	495	0,35	mc. 0.0057

07 pinko-treillis pour dossier
pinko-malla para respaldo

code	finishing	q.kit	q.pack	a	b	kg.x1	vol.x1
132105-501	○ blanc/blanco	x1	25	460	520	0,14	mc. 0.0057
132103-501	● noir/negro	x1	25	460	520	0,14	mc. 0.0057
132104-501	● gris/gris	x1	25	460	520	0,14	mc. 0.0057

and **03** **04**

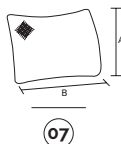
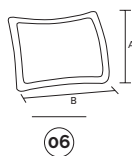

pinko

swivel



plastic colours

- bleu/azul ral5002
- noir/negro
- gris/gris ral7035

main component sizes

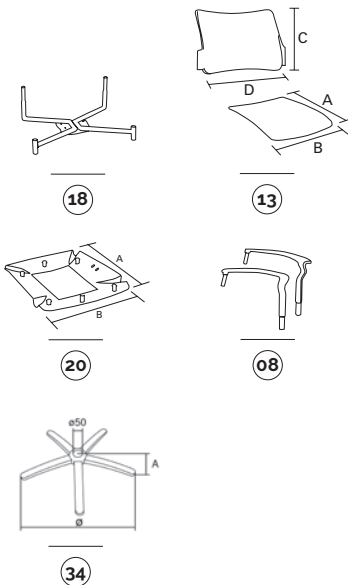

optionals

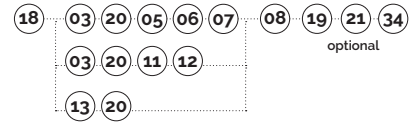
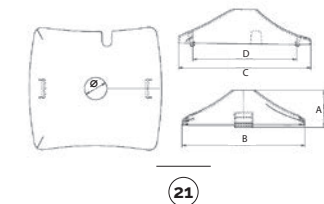

18 pinko-châssis pour pivotant commande au gaz sans embouts
pinko-estructura para versión giratoria accionamiento con gas sin tapones

code	finishing	q.kit	q.pack	kg.x1	vol.x1
112603-045	● noir/negro	x1	80	2,60	mc. 0,005
112604-045	● gris/gris	x1	80	2,60	mc. 0,005

19 embouts couvre-tête à ailettes d.25 noir
tapón embellecedor d.25 negro

code	finishing	q.kit
134103-250	● noir/negro	x2

13 pinko-siège/dossier en plastique coloré + 2 embouts dossier + 2 embouts siège
pinko-asiento/respaldo de plástico de color base + 2 tapones respaldo + 2 tapones asiento

code	finishing	q.kit	q.pack	a	b	c	d	kg.x1	vol.x1
134015-108	● bleu/azul ral 5002	x1	10	470	465	350	495	1,78	mc. 0,014
134003-108	● noir/negro	x1	10	470	465	350	495	1,78	mc. 0,014
134004-109	● gris/gris ral 7035	x1	10	470	465	350	495	1,78	mc. 0,014

20 pinko-siège externe plastique pour pivotant et banquette
pinko-asiento externo de plástico para versión giratoria y bancada

code	finishing	q.kit	q.pack	a	b	kg.x1	vol.x1
132203-027	● noir/negro	x1	20	465	470	0,60	mc. 0,007

08 pinko-paire d'accoudoirs droit-gauche en plastique
pinko-pareja brazos derecho-izquierdo de plástico

code	finishing	q.kit	q.pack	kg.x1	vol.x1
131703-050	● noir/negro	x1	10	0,66	mc. 0,0037

21 cpg-couverture en plastique pour châssis pivotant
cpg-cubierta de plástico para estructura versión giratoria

code	finishing	q.kit	q.pack	a	b	c	d	ø	kg.x1	vol.x1
130903-000	● noir/negro	x1	50	60	200	210	167	36	0,1	mc. 0,0015

34 b40-base en métal avec cache-soudure
b40-base de metal con embellecedor soldadura

code	finishing	q.kit	q.pack	a	ø	kg.x1	vol.x1
110210-027	● chromé/cromado	x1	5	60	640	2,85	mc. 0,014

CPG
plastic cover for swivel frame



pinko

swivel/seat and backrest options

main component sizes

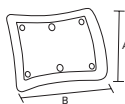

11

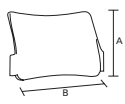

12



11 pinko-dossier interne (habillable)
pinko-respaldo interno (tapizable)

code	finishing	q.kit	q.pack	a	b	kg.x1	vol.x1
132103-025	● noir/negro	x1	20	350	495	0,62	mc. 0.009

12 pinko-dossier externe en plastique + 2 embouts dossier + 2 embouts siège
pinko-respaldo externo de plástico + 2 tapones respaldo + 2 tapones asiento

code	finishing	q.kit	q.pack	a	b	kg.x1	vol.x1
132103-026	● noir/negro	x1	10	350	495	0,25	mc. 0.0045

and **03** **20**

main component sizes

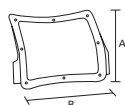

05

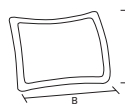

06

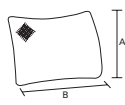

07



05 pinko-châssis dossier en plastique pour treillis (portant) + 2 embouts dossier + 2 embouts siège
pinko-estructura respaldo de plástico para malla (portante) + 2 tapones respaldo + 2 tapones asiento

code	finishing	q.kit	q.pack	a	b	kg.x1	vol.x1
132103-027	● noir/negro	x2	20	345	495	0,50	mc. 0.0045

06 pinko-cadre dossier en plastique pour treillis
pinko-marco respaldo de plástico para malla

code	finishing	q.kit	q.pack	a	b	kg.x1	vol.x1
132103-028	● noir/negro	x1	10	345	495	0,35	mc. 0.0057

07 pinko-treillis pour dossier
pinko-malla para respaldo

code	finishing	q.kit	q.pack	a	b	kg.x1	vol.x1
132105-501	○ blanc/blanco	x1	25	460	520	0,14	mc. 0.0057
132103-501	● noir/negro	x1	25	460	520	0,14	mc. 0.0057
132104-501	● gris/gris	x1	25	460	520	0,14	mc. 0.0057

and **03** **20**

pinko

bench



plastic colours

- bleu/azul ral5002
- noir/negro
- gris/gris ral7035

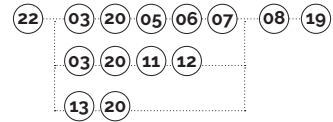

main component sizes

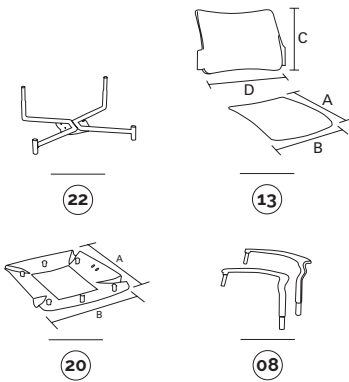

22 pinko-structure pour banquette sans embouts pinko-estructura bancada sin tapones

code	finishing	q.kit	q.pack	kg.x1	vol.x1
110703-072	● noir/negro	x1	80	2,50	mc. 0.005
110704-072	● gris/gris	x1	80	2,50	mc. 0.005

19 embouts couvre-tête à ailettes d.25 noir tapón embellecedor d.25 negro

code	finishing	q.kit
134103-250	● noir/negro	x2

13 pinko-siège/dossier en plastique coloré + 2 embouts dossier + 2 embouts siège pinko-asiento/respaldo de plástico de color base + 2 tapones respaldo + 2 tapones asiento

code	finishing	q.kit	q.pack	a	b	c	d	kg.x1	vol.x1
134015-108	● bleu/azul ral 5002	x1	10	470	465	350	495	1,78	mc. 0.014
134003-108	● noir/negro	x1	10	470	465	350	495	1,78	mc. 0.014
134004-109	● gris/gris ral 7035	x1	10	470	465	350	495	1,78	mc. 0.014

20 pinko-siège externe plastique pour pivotant et banquette pinko-asiento externo de plástico para versión giratoria y bancada

code	finishing	q.kit	q.pack	a	b	kg.x1	vol.x1
132203-027	● noir/negro	x1	20	465	470	0,60	mc. 0.007

08 pinko-paire d'accoudoirs droit-gauche en plastique pinko-pareja brazos derecho-izquierdo de plástico

code	finishing	q.kit	q.pack	kg.x1	vol.x1
131703-050	● noir/negro	x1	10	0,66	mc. 0.0037

for the bench components, see page 201

optionals

OPTIONAL
bench
connector



E-USB **NEW**
bench plug



JIM **NEW**
bench leg



APOLL
bench arm



plastic

90GM
bench leg



90GF
bench leg



100GM
bench leg



200GM
bench leg



PIONEER
bench arm



metal

CUT
bench leg



SLIM
bench leg



CUT
bench arm



SLIM
bench arm



aluminium

pinko

bench/seat and backrest options

main component sizes

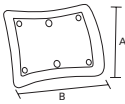

11

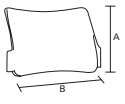

12



- 11 pinko-dossier interne (habillable)
pinko-respaldo interno (tapizable)

code	finishing	q.kit	q.pack	a	b	kg.x1	vol.x1
132103-025	● noir/negro	x1	20	350	495	0,62	mc. 0.009

- 12 pinko-dossier externe en plastique + 2 embouts dossier + 2 embouts siège
pinko-respaldo externo de plástico + 2 tapones respaldo + 2 tapones asiento

code	finishing	q.kit	q.pack	a	b	kg.x1	vol.x1
132103-026	● noir/negro	x1	10	350	495	0,25	mc. 0.0045

and 03 20

main component sizes

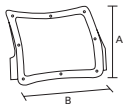

05

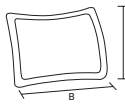

06

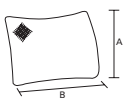

07



- 05 pinko-châssis dossier en plastique pour treillis (portant) + 2 embouts dossier + 2 embouts siège
pinko-estructura respaldo de plástico para malla (portante) + 2 tapones respaldo + 2 tapones asiento

code	finishing	q.kit	q.pack	a	b	kg.x1	vol.x1
132103-027	● noir/negro	x2	20	345	495	0,50	mc. 0.0045

- 06 pinko-cadre dossier en plastique pour treillis
pinko-marco respaldo de plástico para malla

code	finishing	q.kit	q.pack	a	b	kg.x1	vol.x1
132103-028	● noir/negro	x1	10	345	495	0,35	mc. 0.0057

- 07 pinko-treillis pour dossier
pinko-malla para respaldo

code	finishing	q.kit	q.pack	a	b	kg.x1	vol.x1
132105-501	○ blanc/blanco	x1	25	460	520	0,14	mc. 0.0057
132103-501	● noir/negro	x1	25	460	520	0,14	mc. 0.0057
132104-501	● gris/gris	x1	25	460	520	0,14	mc. 0.0057

and 03 20

pinko

folding bench

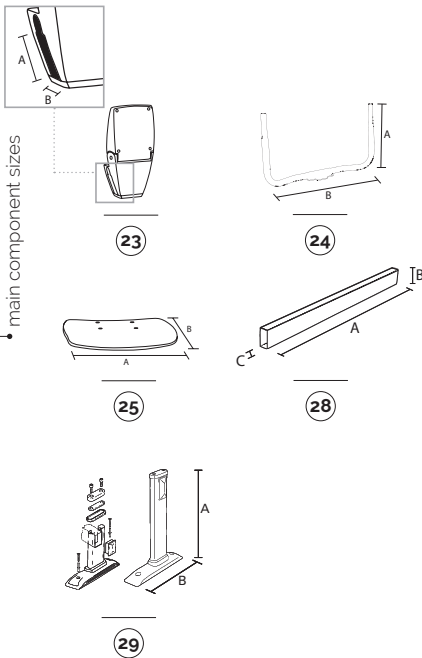
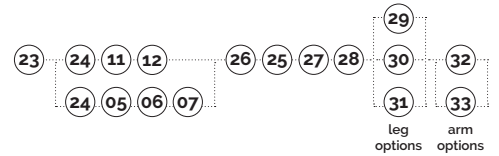

main component sizes

23 siton-mécanisme banquette rabattable en aluminium poli siton-mecanismo bancada abatible de aluminio brillante

code	finishing	q.kit	q.pack	a	b	kg.x1	vol.x1
110704-180	● aluminium/aluminio	x1	4	80	40	2,81	mc. 0,007

24 pinko-châssis dossier en «u» pour banquette rabattable pinko-estructura respaldo en u para bancada abatible

code	finishing	q.kit	q.pack	a	b	kg.x1	vol.x1
110703-071	● noir/negro	x1	15	300	490	1,40	mc. 0,003
110704-182	● gris/gris	x1	15	300	490	1,40	mc. 0,003

25 siton-assise banquette rabattable en bois à revêtir siton-asiento bancada abatible de madera tapizable

code	finishing	q.kit	q.pack	a	b	kg.x1	vol.x1
122207-003	● brut/crudo	x1	10	420	410	1,30	mc. 0,007

26 vis tcei m5x16 brunie noire (vis pour fixation châssis dossier en tube) tornillo tcei m5x16 bruñido negro (tornillo para fijación estructura respaldo tubular)

code	finishing	q.kit
117703-160	● noir/negro	x4

27 vis tcei m6x20 zinguée (vis pour fixation siège) tornillo tcei m6x20 galvanizado (tornillo para fijación asiento)

code	finishing	q.kit
117711-198	● zinguée/galvanizada	x4

28 90t(03) poutre pour banquette 80x40 90t(03) viga para bancada 80x40

code	finishing		q.kit	q.pack	a	b	c	kg.x1	vol.x1
110703-190	● noir/negro	2 places / 2 asientos	x1	1	1160	80	40	3,20	mc. 0,0045
110704-190	● gris/gris	2 places / 2 asientos	x1	1	1160	80	40	3,20	mc. 0,0045
110703-191	● noir/negro	3 places / 3 asientos	x1	1	1710	80	40	4,71	mc. 0,005
110704-191	● gris/gris	3 places / 3 asientos	x1	1	1710	80	40	4,71	mc. 0,005
110703-192	● noir/negro	4 places / 4 asientos	x1	1	2260	80	40	6,22	mc. 0,0085
110704-192	● gris/gris	4 places / 4 asientos	x1	1	2260	80	40	6,22	mc. 0,0085
110703-193	● noir/negro	5 places / 5 asientos	x1	1	2800	80	40	7,72	mc. 0,001
110704-193	● gris/gris	5 places / 5 asientos	x1	1	2800	80	40	7,72	mc. 0,001

29 90gf(02)-ped fixe pour banquette avec accessoires 90gf(02)-pata fija para bancada con accesorios

code	finishing	q.kit	q.pack	a	b	kg.x1	vol.x1
110703-122	● noir/negro	x2	2	320	310	1,80	mc. 0,0012
110704-107	● gris/gris	x2	2	320	310	1,80	mc. 0,0012

for the components below, see page 43

for the bench components, see page 201

pinko

folding bench/tablet accessories



for writing tablet options, see page 192/193

folding bench/seat and backrest option

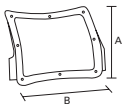

05

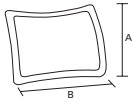

06

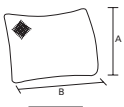

07



- 05 pinko-châssis dossier en plastique pour treillis (portant) + 2 embouts dossier + 2 embouts siège
pinko-estructura respaldo de plástico para malla (portante) + 2 tapones respaldo + 2 tapones asiento

code	finishing	q.kit	q.pack	a	b	kg.x1	vol.x1
132103-027	● noir/negro	x2	20	345	495	0,50	mc. 0.0045

- 06 pinko-cadre dossier en plastique pour treillis
pinko-marco respaldo de plástico para malla

code	finishing	q.kit	q.pack	a	b	kg.x1	vol.x1
132103-028	● noir/negro	x1	10	345	495	0,35	mc. 0.0057

- 07 pinko-treillis pour dossier
pinko-malla para respaldo

code	finishing	q.kit	q.pack	a	b	kg.x1	vol.x1
132105-501	○ blanc/blanco	x1	25	460	520	0,14	mc. 0.0057
132103-501	● noir/negro	x1	25	460	520	0,14	mc. 0.0057
132104-501	● gris/gris	x1	25	460	520	0,14	mc. 0.0057

and 24 26 25 27

folding bench/leg and armrest options

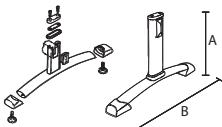

05

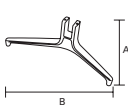

05

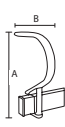

05

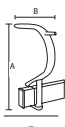

05



- 30 90gm(02)-ped mobile pour banquette avec accessoires
90gm(02)-pata móvil para bancada con accesorios

code	finishing	q.kit	q.pack	a	b	kg.x1	vol.x1
110703-120	● noir/negro	x2	2	320	600	2,70	mc. 0.0012
110704-099	● gris/gris	x2	2	320	600	2,70	mc. 0.0012
110710-007	● chromé/cromado	x2	2	320	600	2,70	mc. 0.0012

- 31 siton(ga02)-ped long en aluminium pour banquette
siton(ga02)-pata larga de aluminio para bancada

code	finishing	q.kit	q.pack	a	b	kg.x1	vol.x1
110704-171	● aluminium/aluminio	x2	5	305	643	2,80	mc. 0.014

- 32 siton-accoudoir elliptique pour banquette avec accessoires
siton-brazo elíptico para bancada con accesorios

code	finishing	q.kit	q.pack	a	b	kg.x1	vol.x1
111710-020	● chromé/cromado	x1	5	370	340	1,70	mc. 0.015
111703-019	● noir/negro	x1	5	370	340	1,70	mc. 0.015

- 33 siton.p-accoudoir elliptique pour banquette avec attelage porte tablette et accessoires
siton.p-brazo elíptico para bancada con gancho para pala con accesorios

code	finishing	q.kit	q.pack	a	b	kg.x1	vol.x1
111710-017	● chromé/cromado	x1	5	370	340	1,70	mc. 0.015
111703-017	● noir/negro	x1	5	370	340	1,70	mc. 0.015