



90



90



side

4 legs

4 legs w/armrests

4 legs w/writing tablet

swivel

bench



EN 1728

tools



certification

go showing



La **série go** se caractérise par un **design classique** et la qualité certifiée de **AlbaComponents**.

Un **large assortiment de châssis et de composants** complètent l'offre d'un produit essentiel et polyvalent, capable de satisfaire tout type d'exigence, en faisant de cette chaise un objet parfait pour tout type d'environnement. **Certifiée CATAS.**

La **Serie go** se caracteriza por un **diseño clásico** y por su reconocida **calidad AlbaComponents**.

Un **surtido amplio de estructuras y componentes** completa la oferta de un producto esencial y versátil, que cumple todas las exigencias en los ámbitos más diversificados, para convertirse en una silla de grandes números. **Certificada CATAS.**

90

4-legs

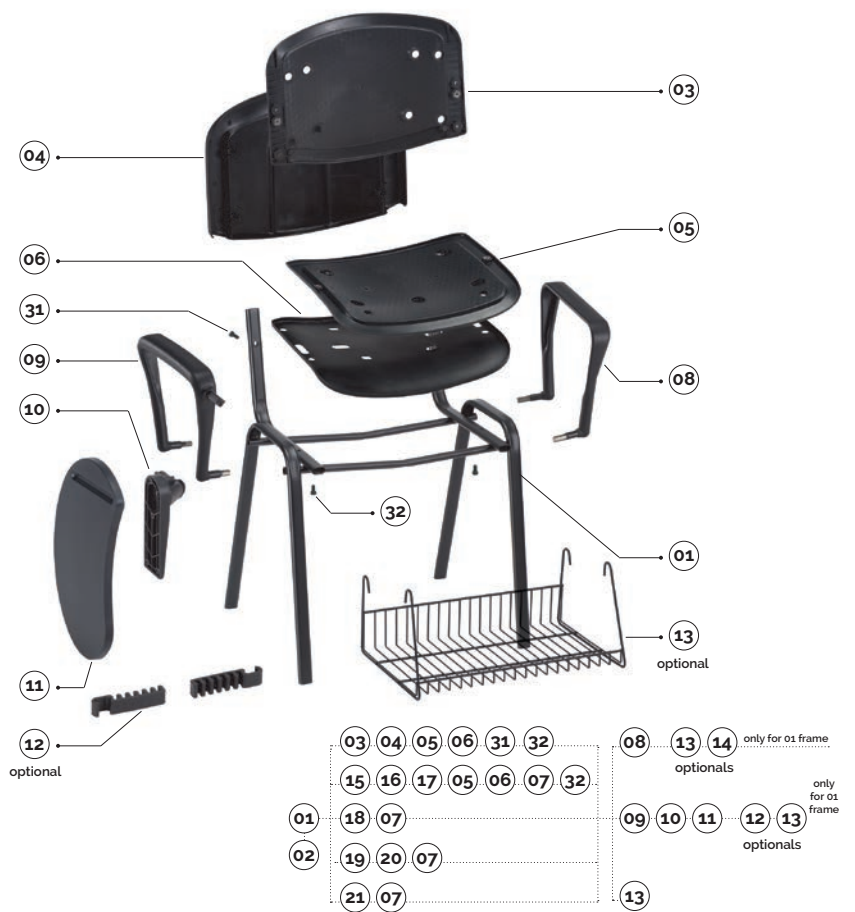

01 g2-châssis pour chaise en tube ovale 30x15 avec embouts latéraux et sous-pieds montés
g2-estructura para silla tubular oval 30x15 con tapones laterales montados para los pies

code	finishing	arm attach	q.kit	q.pack	a	b	kg.x1	vol.x1
112003-005	● noir/negro	12	x1	160	450	425	3,00	mc. 0.021
112003-004	● noir/negro	14	x1	160	450	425	3,00	mc. 0.021
112004-000	● gris/gris	12	x1	160	450	425	3,00	mc. 0.021
112004-002	● gris/gris	14	x1	160	450	425	3,00	mc. 0.021
112010-008	● chromé/cromado	12	x1	160	450	425	3,00	mc. 0.021
112010-005	● chromé/cromado	14	x1	160	450	425	3,00	mc. 0.021

02 g2-châssis pour chaise en tube ovale 30x15 avec attelage latéral en métal soudé, embouts latéraux et sous-pieds montés
g2-estructura para silla tubular oval 30x15 con enganche lateral metálico soldado y tapones laterales montados para los pies

code	finishing	arm attach	q.kit	q.pack	a	b	kg.x1	vol.x1
112003-016	● noir/negro	12	x1	160	450	425	3,00	mc. 0.021
112003-015	● noir/negro	14	x1	160	450	425	3,00	mc. 0.021
112004-007	● gris/gris	12	x1	160	450	425	3,00	mc. 0.021
112004-008	● gris/gris	14	x1	160	450	425	3,00	mc. 0.021
112010-016	● chromé/cromado	12	x1	160	450	425	3,00	mc. 0.021
112010-015	● chromé/cromado	14	x1	160	450	425	3,00	mc. 0.021

03 goshi-dossier interne en plastique
goshi-respaldo interno de plástico

code	finishing	q.kit	q.pack	a	b	kg.x1	vol.x1
132103-002	● noir/negro	x1	40	330	470	0,60	mc. 0.004

04 goshe-couvre-dossier externe en plastique
goshe-respaldo externo de plástico

code	finishing	q.kit	q.pack	a	b	kg.x1	vol.x1
132103-001	● noir/negro	x1	30	475	335	0,40	mc. 0.004

05 gosdi-assise interne en plastique
gosdi-asiento interno de plástico

code	finishing	q.kit	q.pack	a	b	kg.x1	vol.x1
132203-002	● noir/negro	x1	30	460	400	0,80	mc. 0.004

06 gosde-assise externe en plastique
gosde-asiento externo de plástico

code	finishing	q.kit	q.pack	a	b	kg.x1	vol.x1
132203-001	● noir/negro	x1	80	410	465	0,40	mc. 0.003

31 vis tsp+ m6x20 zinguée blanche
tornillo tsp+ m6x20 galvanizada blanca

code	finishing	q.kit
117711-203	● zinguée blanche/galvanizada blanca	x2

32 vis tsp+ m6x25 zinguée blanche
tornillo tsp+ m6x25 galvanizada blanca

code	finishing	q.kit
117711-199	● zinguée blanche/galvanizada blanca	x2

08 gob-accoudoir en nylon
gob-brazo de nailon

code	finishing	arm attach	q.kit	q.pack	a	b	c	kg.x1	vol.x1
131703-002	● noir/negro	14	x2	20	290	250	190	0,80	mc. 0.0026
131703-004	● noir/negro	12	x2	20	290	250	190	0,80	mc. 0.0026

12 clipsages réglables pour tube ovale 15x30 pp
pareja pinzas regulables para tubular oval 15x30 pp

code	finishing	q.kit	q.pack	a	b
134003-002	● noir/negro	x1	200	214	134

13 g2c-porte-revues
g2c-rejilla revistero

code	finishing	q.kit	q.pack	kg.x1	vol.x1
113403-001	● noir/negro	x1	25	0,975	mc. 0.03
113410-020	● chromé/cromado	x1	25	0,975	mc. 0.03

attelage latéral mâle+female en plastique + 2 vis
enganche lateral macho+hembra de plástico + 2 tornillos
134003-132

main component sizes

optionals

90

4-legs/tablet accessories

main component sizes



09

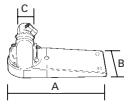

10

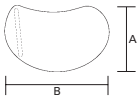

11

09 gobp-accoudoir en nylon avec attelage porte tablette
gobp-brazo de nailon con enganche para pala

code	finishing	arm attach	q.kit	q.pack	a	b	c	d	kg.x1	vol.x1
131703-001	● noir/negro	14	x1	20	290	250	190	15x15	0,80	mc. 0,0026
131703-003	● noir/negro	12	x1	20	290	250	190	15x15	0,80	mc. 0,0026

10 spt2-rotule pour tablette en thermoplastique
spt2-articulación para pala de termoplástico

code	finishing	q.kit	q.pack	a	b	c	kg.x1	vol.x1
134003-039	● noir/negro	x1	20	180	66	15x15	0,35	mc. 0,0006

11 bean-tablette en thermoplastique ovale épaisseur 16 mm
bean-pala de material termoplástico oval grosor 16 mm

code	finishing	q.kit	q.pack	a	b	kg.x1	vol.x1
134003-044	● noir/negro	x1	20	235	370	0,40	mc. 0,002

TLT
tablet

TLT2
tablet

TLT3
tablet

BEAN
tablet

TL02
tablet

SPT2
mechanism tablet

SPTA
mechanism antipanico



for writing tablet options, see page 192/193

4-legs/backrest and seat options

main component sizes

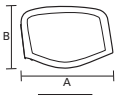

15

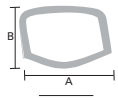

16

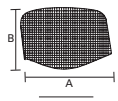

17



15 isonet-châssis dossier en plastique avec vis pour treillis
isonet-estructura respaldo de plástico con tornillos para malla

code	finishing	q.kit	q.pack	a	b	kg.x1	vol.x1
132103-003	● noir/negro	x1	25	470	345	0,42	mc. 0,006

16 isonet-cadre dossier en plastique pour treillis
isonet-marco respaldo de plástico para malla

code	finishing	q.kit	q.pack	a	b	kg.x1	vol.x1
132103-004	● noir/negro	x1	25	470	345	0,31	mc. 0,004

17 isonet-treillis pour dossier
isonet-malla para respaldo

code	finishing	q.kit	q.pack	a	b	kg.x1	vol.x1
132105-500	○ blanc/blanco	x1	25	550	400	0,14	mc. 0,0057
132103-500	● noir/negro	x1	25	550	400	0,14	mc. 0,0057
132102-500	● rouge/rojo	x1	25	550	400	0,14	mc. 0,0057

07 vis tête évasée croix m6x18 brunie noire-fixation siège/ dossier hêtre
tornillo cabeza avellanada en cruz m6x18 bruñido negro - fijación asiento / respaldo haya

code	finishing	q.kit
117703-195	● noir/negro	x4

and · 05 06 32

18 novx-siège et dossier en plastique pour châssis en tube ovale et en tube elliptique
novx-asiento y respaldo de plástico disponibles para estructura tubular oval y tubular elíptico

code	finishing	q.kit	q.pack	a	b	c	d	kg.x1	vol.x1
134002-001	● rouge/rojo	x1	20	470	315	460	400	1,21	mc. 0,008
134003-119	● noir/negro	x1	20	470	315	460	400	1,21	mc. 0,008
134015-003	● bleu/azul	x1	20	470	315	460	400	1,21	mc. 0,008

and · 07

19 prisma-siège et dossier en plastique pour châssis en tube ovale et en tube elliptique
prisma-asiento y respaldo de plástico disponibles para estructura tubular oval y tubular elíptico

code	finishing	q.kit	q.pack	a	b	c	d	kg.x1	vol.x1
134003-110	● noir/negro	x1	10	470	330	460	430	1,60	mc. 0,016

20 prisma-panneau assise pour tapisserie
prisma-panel asiento para tapizar

code	finishing	q.kit	q.pack	a	b	kg.x1	vol.x1
132203-010	● noir/negro	x1	20	400	400	0,40	mc. 0,004

and · 07

21 goshsdif-dossier + siège multicouches verni hêtre + 4 embouts
goshsdif-respaldo + asiento contrachapado pintado haya + 4 terminales

code	finishing	q.kit	q.pack	a	b	c	d	e	f	kg.x1	vol.x1
124007-000	● hêtre/haya	x1	10	325	465	415	460	10	10	2,70	mc. 0,07

and · 07

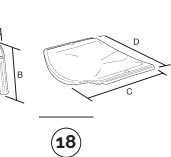

18

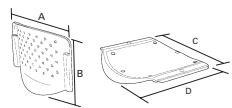

19

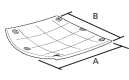

20

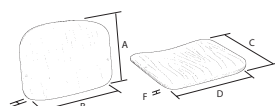

21

90

4-legs w/armrests

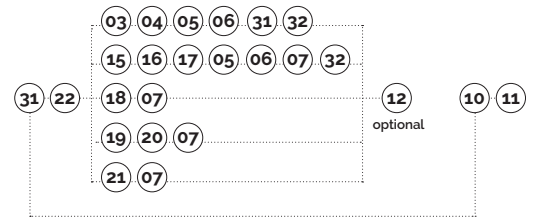

main component sizes

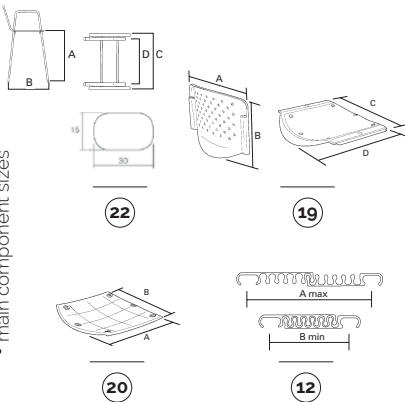

22 g4-châssis pour chaise en tube ovale 30x15 avec accoudoirs, embouts latéraux et sous pieds montés
g4-estructura para silla tubular oval 30x15 con brazos y tapones laterales y para los pies montados

code	finishing	q.kit	q.pack	a	b	c	d	kg.x1	vol.x1
112003-020	● noir/negro	x1	80	450	470	545	425	3,80	mc. 0,042
112004-021	● gris/gris	x1	80	450	470	545	425	3,80	mc. 0,042
112010-040	● chromé/cromado	x1	80	450	470	545	425	3,80	mc. 0,042

19 prisma-siège et dossier en plastique pour châssis en tube ovale et en tube elliptique
prisma-asiento y respaldo de plástico disponibles para estructura tubular oval y tubular elíptico

code	finishing	q.kit	q.pack	a	b	c	d	kg.x1	vol.x1
134003-110	● noir/negro	x1	10	470	330	460	430	1,60	mc. 0,016

20 prisma-panneau assise pour tapisserie
prisma-panel asiento para tapizar

code	finishing	q.kit	q.pack	a	b	kg.x1	vol.x1
132203-010	● noir/negro	x1	20	400	400	0,40	mc. 0,004

07 vis tête évasée croix m6x18 brunie noire-fixation siège/ dossier hêtre
tornillo cabeza avellanada en cruz m6x18 bruñido negro - fijación asiento / respaldo haya

code	finishing	q.kit
117703-195	● noir/negro	x4

12 clipsages réglables pour tube ovale 15x30 pp
pareja pinzas regulables para tubular oval 15x30 pp

code	finishing	q.kit	q.pack	a	b
134003-002	● noir/negro	x1	200	214	134

90

4-legs with armrests/tablet accessories

main component sizes

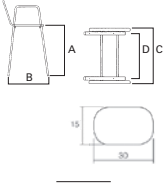

31



crochet pour tablette
gancho para pala

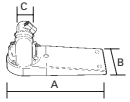

10

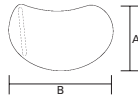

11

- 31 94-châssis pour chaise en tube ovale 30x15 avec accoudoirs pour tablette
94-estructura para silla tubular oval 30x15 con brazos para pala

code	finishing	q.kit	q.pack	a	b	c	d	kg.x1	vol.x1
112003-022	● noir/negro	x1	80	450	470	545	425	3,80	mc. 0.042
112004-022	● gris/gris	x1	80	450	470	545	425	3,80	mc. 0.042
112010-043	● chromé/cromado	x1	80	450	470	545	425	3,80	mc. 0.042

- 10 spt2-rotule pour tablette en thermoplastique
spt2-articulación para pala de termoplástico

code	finishing	q.kit	q.pack	a	b	c	kg.x1	vol.x1
134003-039	● noir/negro	x1	20	180	66	15x15	0,35	mc. 0.0006

- 11 bean-tablette en thermoplastique ovale épaisseur 16 mm
bean-pala de material termoplástico oval grosor 16 mm

code	finishing	q.kit	q.pack	a	b	kg.x1	vol.x1
134003-044	● noir/negro	x1	20	235	370	0,40	mc. 0.002

TLT tablet TLT2 tablet TLT3 tablet BEAN tablet TL02 tablet SPT2 mechanism tablet SPTA mechanism antipanic



for writing tablet options, see page 192/193

4-legs with armrests/backrest and seat options

main component sizes

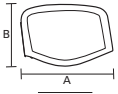

15

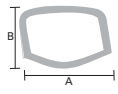

16

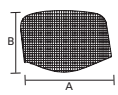

17



- 15 isonet-châssis dossier en plastique avec vis pour treillis
isonet-estructura respaldo de plástico con tornillos para malla

code	finishing	q.kit	q.pack	a	b	kg.x1	vol.x1
132103-003	● noir/negro	x1	25	470	345	0,42	mc. 0.006

- 16 isonet-cadre dossier en plastique pour treillis
isonet-marco respaldo de plástico para malla

code	finishing	q.kit	q.pack	a	b	kg.x1	vol.x1
132103-004	● noir/negro	x1	25	470	345	0,31	mc. 0.004

- 17 isonet-trellis pour dossier
isonet-malla para respaldo

code	finishing	q.kit	q.pack	a	b	kg.x1	vol.x1
132105-500	○ blanc/blanco	x1	25	550	400	0,14	mc. 0.0057
132103-500	● noir/negro	x1	25	550	400	0,14	mc. 0.0057
132102-500	● rouge/rojo	x1	25	550	400	0,14	mc. 0.0057

and · 05 06 07 32

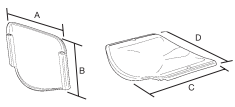

18



- 18 novx-siège et dossier en plastique pour châssis en tube ovale et en tube elliptique
novx-asiento y respaldo de plástico disponibles para estructura tubular ovale y tubular elliptique

code	finishing	q.kit	q.pack	a	b	c	d	kg.x1	vol.x1
134002-001	● rouge/rojo	x1	20	470	315	460	400	1,21	mc. 0.008
134003-119	● noir/negro	x1	20	470	315	460	400	1,21	mc. 0.008
134015-003	● bleu/azul	x1	20	470	315	460	400	1,21	mc. 0.008

and · 07

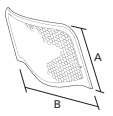

03



- 03 goshi-dossier interne en plastique
goshi-respaldo interno de plástico

code	finishing	q.kit	q.pack	a	b	kg.x1	vol.x1
132103-002	● noir/negro	x1	40	330	470	0,60	mc. 0.004

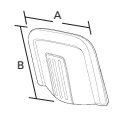

04

- 04 goshe-couvre-dossier externe en plastique
goshe-respaldo externo de plástico

code	finishing	q.kit	q.pack	a	b	kg.x1	vol.x1
132103-001	● noir/negro	x1	30	475	335	0,40	mc. 0.004

and · 05 06 31 32

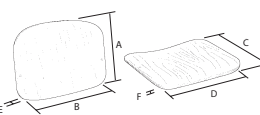

21



- 21 goshsdif-dossier + siège multicouches verni hêtre + 4 embouts
goshsdif-respaldo + asiento contrachapado pintado haya + 4 terminales

code	finishing	q.kit	q.pack	a	b	c	d	e	f	kg.x1	vol.x1
124007-000	● hêtre/haya	x1	10	325	465	415	460	10	10	2,70	mc. 0.07

and · 07

90 slide

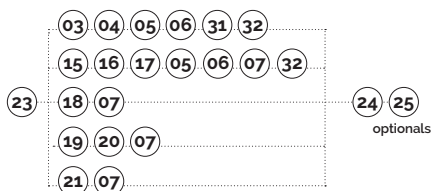
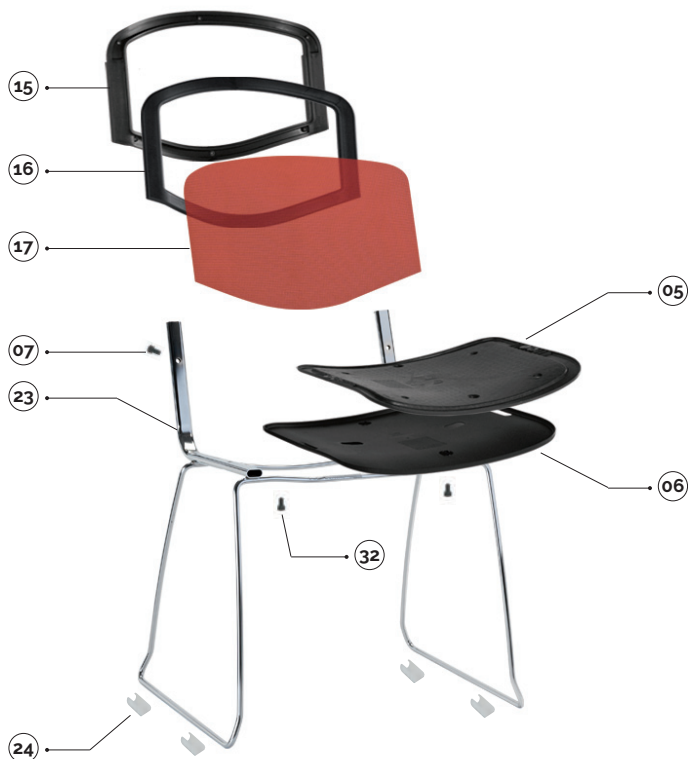

main component sizes

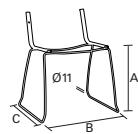

23

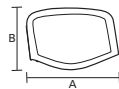

15

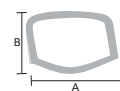

16

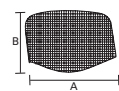

17

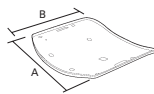

05

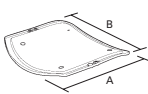

06



24



25

optionals

23 spritz-châssis ferme tige ø11 embouts exclus spritz-estructura cerrada de varilla d.11 tapones excluidos

code	finishing	q.kit	q.pack	a	b	c	kg.x1	vol.x1
112010-250	● chromé/cromado	x1	100	450	580	470	4,00	mc. 0,042

24 pack de bases à pince anti-rotation pour tige couleur neutre paquete de bases con pinza antirrotación para varilla de color neutro

code	finishing	q.kit	q.pack
137006-070	○ neutro/neutral	x4	200

25 base plate à pince double en pe pour élément de jonction chaises base plana con pinza doble de pe para varilla para unión sillas

code	finishing	q.kit
134006-021	○ neutro/neutral	x4

15 isonet-châssis dossier en plastique avec vis pour treillis isonet-estructura respaldo de plástico con tornillos para malla

code	finishing	q.kit	q.pack	a	b	kg.x1	vol.x1
132103-003	● noir/negro	x1	25	470	345	0,42	mc. 0,006

16 isonet-cadre dossier en plastique pour treillis isonet-marco respaldo de plástico para malla

code	finishing	q.kit	q.pack	a	b	kg.x1	vol.x1
132103-004	● noir/negro	x1	25	470	345	0,31	mc. 0,004

17 isonet-treillis pour dossier isonet-malla para respaldo

code	finishing	q.kit	q.pack	a	b	kg.x1	vol.x1
132105-500	○ blanc/blanco	x1	25	550	400	0,14	mc. 0,0057
132103-500	● noir/negro	x1	25	550	400	0,14	mc. 0,0057
132102-500	● rouge/rojo	x1	25	550	400	0,14	mc. 0,0057

05 gosdi-assise interne en plastique gosdi-asiento interno de plástico

code	finishing	q.kit	q.pack	a	b	kg.x1	vol.x1
132203-002	● noir/negro	x1	30	460	400	0,80	mc. 0,004

06 gosde-assise externe en plastique gosde-asiento externo de plástico

code	finishing	q.kit	q.pack	a	b	kg.x1	vol.x1
132203-001	● noir/negro	x1	80	410	465	0,40	mc. 0,003

07 vis tête évasée croix m6x18 brunie noire-fixation siège/ dossier hêtre tornillo cabeza avellanada en cruz m6x18 bruñido negro - fijación asiento / respaldo haya

code	finishing	q.kit
117703-195	● noir/negro	x4

32 vis tsp+ m6x25 zinguée blanche tornillo tsp+ m6x25 galvanizada blanca

code	finishing	q.kit
117711-199	● zinguée blanche/galvanizada blanca	x2

90

slide/backrest and seat options

main component sizes

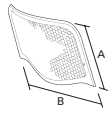

03

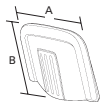

04



03 goshi-dossier interne en plastique
goshi-respaldo interno de plástico

code	finishing	q.kit	q.pack	a	b	kg.x1	vol.x1
132103-002	● noir/negro	x1	40	330	470	0.60	mc. 0.004

04 goshe-couvre-dossier externe en plastique
goshe-respaldo externo de plástico

code	finishing	q.kit	q.pack	a	b	kg.x1	vol.x1
132103-001	● noir/negro	x1	30	475	335	0.40	mc. 0.004

and · **05** **06** **31** **32**

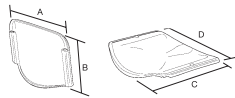

18



18 novx-siège et dossier en plastique pour châssis en tube ovale et en tube elliptique
novx-asiento y respaldo de plástico disponibles para estructura tubular ovale y tubular elliptico

code	finishing	q.kit	q.pack	a	b	c	d	kg.x1	vol.x1
134002-001	● rouge/rojo ral3002	x1	20	470	315	460	400	1.21	mc. 0.008
134003-119	● noir/negro ral9005	x1	20	470	315	460	400	1.21	mc. 0.008
134015-003	● bleu/azul ral5002	x1	20	470	315	460	400	1.21	mc. 0.008

and · **07**

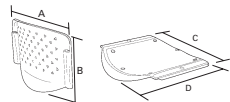

19



19 prisma-siège et dossier en plastique pour châssis en tube ovale et en tube elliptique
prisma-asiento y respaldo de plástico disponibles para estructura tubular ovale y tubular elliptico

code	finishing	q.kit	q.pack	a	b	c	d	kg.x1	vol.x1
134003-110	● noir/negro	x1	10	470	330	460	430	1.60	mc. 0.016

20 prisma-panneau assise pour tapisserie
prisma-panel asiento para tapizar

code	finishing	q.kit	q.pack	a	b	kg.x1	vol.x1
132203-010	● noir/negro	x1	20	400	400	0.40	mc. 0.004

and · **07**

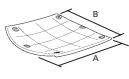

20

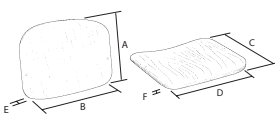

21



21 goshsdlf-dossier + siège multicouches verni hêtre + 4 embouts
goshsdlf-respaldo + asiento contrachapado pintado haya + 4 terminales

code	finishing	q.kit	q.pack	a	b	c	d	e	f	kg.x1	vol.x1
124007-000	● hêtre/haya	x1	10	325	465	415	460	10	10	2.70	mc. 0.07

and · **07**

90 swivel

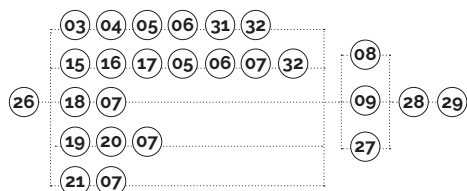

main component sizes

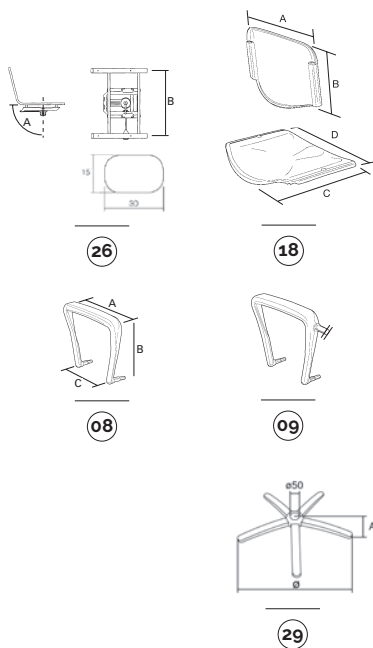

26 g2gy-châssis pour chaise pivotant en tube ovale 30x15 avec plaque de commande au gaz, avec spatule, sans embouts
g2gy-estructura para silla giratoria tubular oval 30x15 con placa de accionamiento con mecanismo de gas con palanca, tapones excluidos

code	finishing	arm attach	q.kit	q.pack	a	b	kg.x1	vol.x1
112003-200	● noir/negro	14	x1	200	87"	425	2.62	mc. 0.015
112003-201	● noir/negro	12	x1	200	87"	425	2.62	mc. 0.015
112010-200	● chromé/cromado	14	x1	200	87"	425	2.62	mc. 0.015
112010-201	● chromé/cromado	12	x1	200	87"	425	2.62	mc. 0.015

18 novx-siège et dossier en plastique pour châssis en tube ovale et en tube elliptique
novx-asiento y respaldo de plástico disponibles para estructura tubular oval y tubular elíptico

code	finishing	q.kit	q.pack	a	b	c	d	kg.x1	vol.x1
134002-001	● rouge/rojo	ral3002	x1	20	470	315	460 400	1.21	mc. 0.008
134003-119	● noir/negro	ral9005	x1	20	470	315	460 400	1.21	mc. 0.008
134015-003	● bleu/azul	ral5002	x1	20	470	315	460 400	1.21	mc. 0.008

08 gob-accoudoir en nylon
gob-brazo de nailon

code	finishing	arm attach	q.kit	q.pack	a	b	c	kg.x1	vol.x1
131703-002	● noir/negro	14	x2	20	290	250	190	0.80	mc. 0.0026
131703-004	● noir/negro	12	x2	20	290	250	190	0.80	mc. 0.0026

09 gobp-accoudoir en nylon avec attelage porte tablette
gobp-brazo de nailon con enganche para pala

code	finishing	arm attach	q.kit	q.pack	a	b	c	d	kg.x1	vol.x1
131703-001	● noir/negro	14	x1	20	290	250	190	15x15	0.80	mc. 0.0026
131703-003	● noir/negro	12	x1	20	290	250	190	15x15	0.80	mc. 0.0026

07 vis tête évasée croix m6x18 brunie noire-fixation siège/ dossier hêtre
tornillo cabeza avellanada en cruz m6x18 bruñido negro - fijación asiento / respaldo haya

code	finishing	q.kit
117703-195	● noir/negro	x4

27 pack embouts couvre-tête ø18 noir
paquete de tapones embellecedores d.18 negro

code	finishing	diameter	q.kit	q.pack
137003-070	● noir/negro	ø18	x4	200
134103-151	● noir/negro	ø15	x4	

28 pack embouts couvre-tête ovales 30x15 noirs
paquete de tapones embellecedores ovales 30x15 negros

code	finishing	q.kit	q.pack
137003-071	● noir/negro	x4	200

29 b40-base en métal avec cache-soudure
b40-base de metal con embellecedor soldadura

code	finishing	q.kit	q.pack	a	ø	kg.x1	vol.x1
110210-027	● chromé/cromado	x1	5	60	640	2.85	mc. 0.014

90

swivel/backrest and seat options

main component sizes

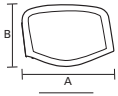

15

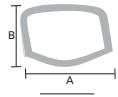

16

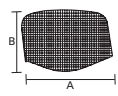

17



- 15 isonet-châssis dossier en plastique avec vis pour treillis
isonet-estructura respaldo de plástico con tornillos para malla

code	finishing	q.kit	q.pack	a	b	kg.x1	vol.x1
132103-003	● noir/negro	x1	25	470	345	0,42	mc. 0,006

- 16 isonet-cadre dossier en plastique pour treillis
isonet-marco respaldo de plástico para malla

code	finishing	q.kit	q.pack	a	b	kg.x1	vol.x1
132103-004	● noir/negro	x1	25	470	345	0,31	mc. 0,004

- 17 isonet-trellis pour dossier
isonet-malla para respaldo

code	finishing	q.kit	q.pack	a	b	kg.x1	vol.x1
132105-500	○ blanc/blanco	x1	25	550	400	0,14	mc. 0,0057
132103-500	● noir/negro	x1	25	550	400	0,14	mc. 0,0057
132102-500	● rouge/rojo	x1	25	550	400	0,14	mc. 0,0057

and · 05 06 07 32

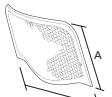

03

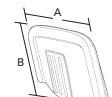

04



- 03 goshi-dossier interne en plastique
goshi-respaldo interno de plástico

code	finishing	q.kit	q.pack	a	b	kg.x1	vol.x1
132103-002	● noir/negro	x1	40	330	470	0,60	mc. 0,004

- 04 goshe-couvre-dossier externe en plastique
goshe-respaldo externo de plástico

code	finishing	q.kit	q.pack	a	b	kg.x1	vol.x1
132103-001	● noir/negro	x1	30	475	335	0,40	mc. 0,004

and · 05 06 31 32

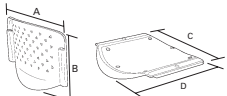

19

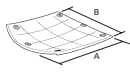

20



- 19 prisma-siège et dossier en plastique pour châssis en tube ovale et en tube elliptique
prisma-asiento y respaldo de plástico disponibles para estructura tubular oval y tubular elíptico

code	finishing	q.kit	q.pack	a	b	c	d	kg.x1	vol.x1
134003-110	● noir/negro	x1	10	470	330	460	430	1,60	mc. 0,016

- 20 prisma-panneau assise pour tapisserie
prisma-panel asiento para tapizar

code	finishing	q.kit	q.pack	a	b	kg.x1	vol.x1
132203-010	● noir/negro	x1	20	400	400	0,40	mc. 0,004

and · 07

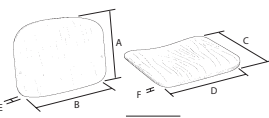

21



- 21 goshsdlf-dossier + siège multicouches verni hêtre + 4 embouts
goshsdlf-respaldo + asiento contrachapado pintado haya + 4 terminales

code	finishing	q.kit	q.pack	a	b	c	d	e	f	kg.x1	vol.x1
124007-000	● hêtre/haya	x1	10	325	465	415	460	10	10	2,70	mc. 0,07

and · 07

90 bench



CERTIFIED BY
CATAS

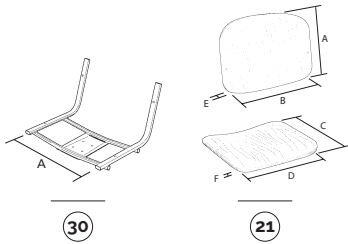
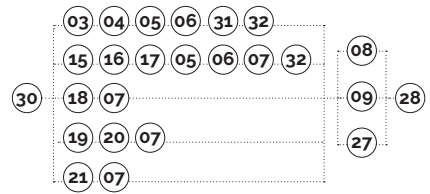

30 92pv-châssis en tube ovale ou elliptique pour banquette vernie
92pv-estructura tubular oval o eliptica para bancada pintada

code	finishing	arm attach	q.kit	q.pack	a	kg.x1	vol.x1
110703-061	● nero/black	12 ovale/oval	x1	200	425	2,20	mc. 0.015
110703-062	● nero/black	14 ovale/oval	x1	200	425	2,20	mc. 0.015

21 90shsdlf-dossier + siège multicouches verni hêtre + 4 embouts
90shsdlf-respaldo + asiento contrachapado pintado haya + 4 terminales

code	finishing	q.kit	q.pack	a	b	c	d	e	f	kg.x1	vol.x1
124007-000	● hêtre/haya	x1	10	325	465	415	460	10	10	2,70	mc. 0.07

07 vis tête évasée croix m6x18 brunie noire-fixation siège/ dossier hêtre
tornillo cabeza avellanada en cruz m6x18 bruñido negro - fijación asiento / respaldo haya

code	finishing	q.kit
117703-195	● noir/negro	x4

27 pack embouts couvre-tête ø18 noir
paquete de tapones embellecedores d.18 negro

code	finishing	diameter	q.kit	q.pack
137003-070	● noir/negro	ø18	x4	200
134103-151	● noir/negro	ø15	x4	

28 pack embouts couvre-tête ovales 30x15 noirs
paquete de tapones embellecedores ovales 30x15 negros

code	finishing	q.kit	q.pack
137003-071	● noir/negro	x4	200

for the bench components, see page 201

OPTIONAL
bench
connector



JIM **NEW**
bench leg



APOLL
bench arm



plastic

90GM
bench leg



90GF
bench leg



100GM
bench leg



200GM
bench leg



PIONEER
bench arm



metal

CUT
bench leg



SLIM
bench leg



CUT
bench arm



SLIM
bench arm



aluminium

