

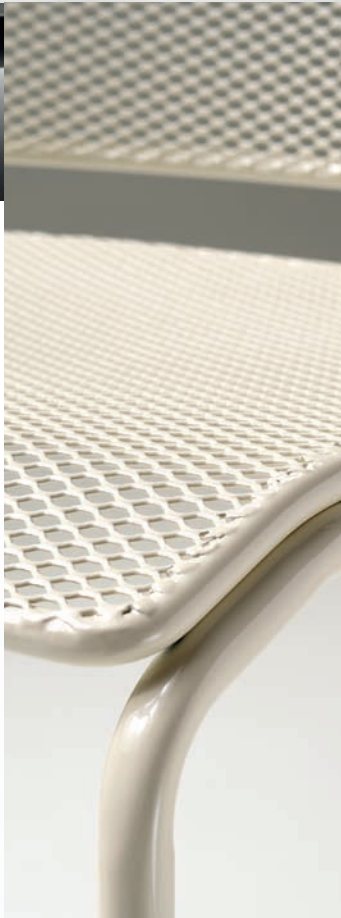

BEYOND | **Design**





**tapas**



# tapas



stool

high table

low table

coffee table

metal slide  
metal 4-legs  
metal stool

# tapas showing



tools



brochure

## features



designed by:  
edi & paolo ciani design



outdoor  
ready



### La nuova linea per l'ambiente Ho.re.ca.

Una collezione innovativa e completa, che si sviluppa in due famiglie. La prima, per uso **indoor & outdoor**, è completamente smontabile, pratica nell'assemblaggio e di grande solidità, con un design funzionale e versatile grazie alle numerose varianti di finitura. La seconda è pensata **appositamente per l'outdoor**, con telai dedicati e finiture dei materiali ideali per questo tipo di utilizzo.

#### Plus di utilizzo:

- numerose varianti di finitura;
- versatilità nell'utilizzo grazie alle specifiche finiture per l'outdoor;
- i kit della famiglia indoor & outdoor prevedono un imballo smontato per ridurre i costi di movimentazione;
- semplice da assemblare.

Tapas è ideale per l'ambiente Contract.

### *The new product line for the Ho.re.ca environment.*

*An innovative and complete collection that is divided into two families. The first, for **indoor & outdoor** use, can be completely disassembled, is easy to assemble and is very solid, with a functional and versatile design due to its numerous finish variations. The second is designed **specifically for outdoor use**, with dedicated frames and material finishes that are ideal for this type of use.*

#### Advantages:

- numerous finish variations;
- versatility in its use due to the specific finished for outdoor use;
- the indoor & outdoor family kits come in a disassembled package to reduce handling costs;
- easy to assemble.

Tapas is ideal for the **Contract** environment.

# tapas

## stool

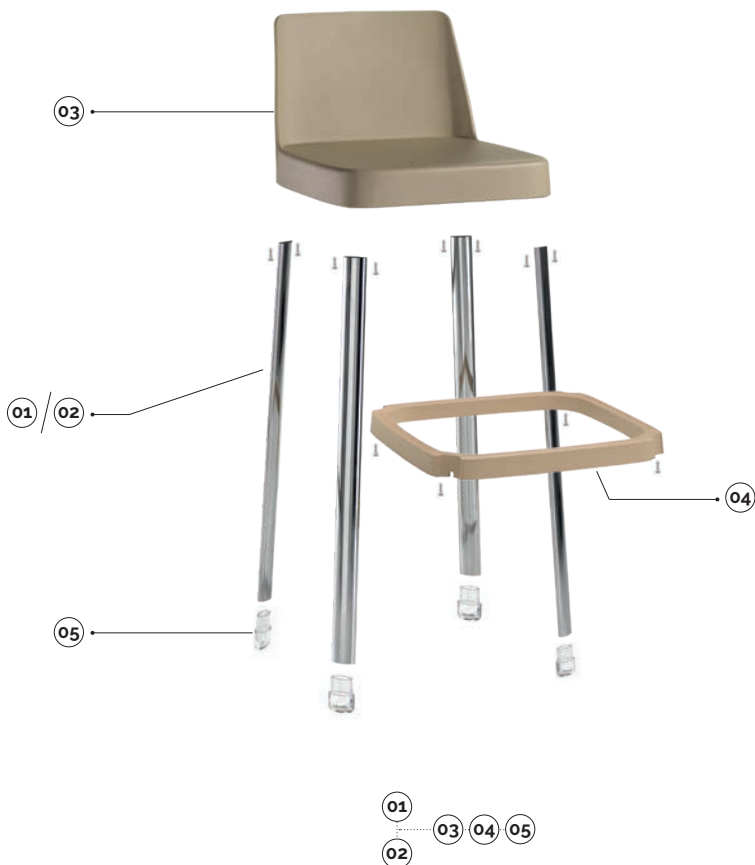

plastic colours

- avorio/ivory ral1013
- nocciola/hazelnut 2312u
- grigio/grey ig2621
- nero/black ral9005

Corten ● \*Specifica caratteristica del Corten è la variabilità nella tonalità della finitura.  
\* A specific characteristic of Corten is the variability in the tone of the finish.

main component sizes

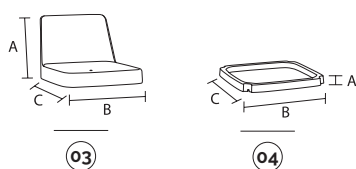
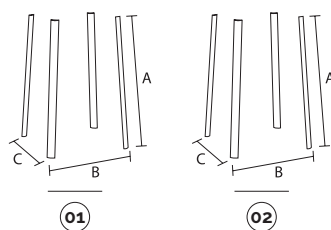

### 01 tapas-sgabello h650 kit n'4 gambe con viti

tapas-kit stool h650 n'4 legs with screws

code	finishing	q.kit	q.pack	a	b	c	kg.x1	vol.x1
110603-637	● nero/black	x1	5	650	410	410	3.54	mc. 0.0035
110604-637	● grigio/grey ig2621	x1	5	650	410	410	3.54	mc. 0.0035
110605-637	● avorio/ivory ral 1013	x1	5	650	410	410	3.54	mc. 0.0035
110607-637	● corten*	x1	5	650	410	410	3.54	mc. 0.0035
110610-637	● cromato/chrome	x1	5	650	410	410	3.54	mc. 0.0035
110603-638	● nero/black	x1	5	650	410	410	3.54	mc. 0.0035
110604-638	● grigio/grey ig2621	x1	5	650	410	410	3.54	mc. 0.0035
110605-638	● avorio/ivory ral 1013	x1	5	650	410	410	3.54	mc. 0.0035
110607-638	● corten*	x1	5	650	410	410	3.54	mc. 0.0035

### 02 tapas-sgabello h750 kit n'4 gambe con viti

tapas-kit stool h750 n'4 legs with screws

code	finishing	q.kit	q.pack	a	b	c	kg.x1	vol.x1
110603-635	● nero/black	x1	5	750	422	422	3.54	mc. 0.0035
110604-635	● grigio/grey ig2621	x1	5	750	422	422	3.54	mc. 0.0035
110605-635	● avorio/ivory ral 1013	x1	5	750	422	422	3.54	mc. 0.0035
110607-635	● corten*	x1	5	750	422	422	3.54	mc. 0.0035
110610-635	● cromato/chrome	x1	5	750	422	422	3.54	mc. 0.0035
110603-636	● nero/black	x1	5	750	422	422	3.54	mc. 0.0035
110604-636	● grigio/grey ig2621	x1	5	750	422	422	3.54	mc. 0.0035
110605-636	● avorio/ivory ral 1013	x1	5	750	422	422	3.54	mc. 0.0035
110607-636	● corten*	x1	5	750	422	422	3.54	mc. 0.0035

### 03 tapas-scocca seduta sgabello

tapas-stool plastic shell

code	finishing	q.kit	q.pack	a	b	c	kg.x1	vol.x1
130603-003	● nero/black	x1	5	276	382	458	2.06	mc. 0.02045
130604-001	● grigio/grey 650	x1	5	276	382	458	2.06	mc. 0.02045
130605-003	● avorio/ivory ral 1013	x1	5	276	382	458	2.06	mc. 0.02045
130607-003	● nocciola/hazelnut 2312u	x1	5	276	382	458	2.06	mc. 0.02045

### 04 tapas-poggiapiedi sgabello

tapas-stool footrest

code	finishing	q.kit	a	b	c	kg.x1		
130603-000	● nero/black	x1	5	34	417	417	0.874	mc. 0.01092
130604-000	● grigio/grey 650	x1	5	34	417	417	0.874	mc. 0.01092
130605-002	● avorio/ivory ral 1013	x1	5	34	417	417	0.874	mc. 0.01092
130607-000	● nocciola/hazelnut 2312u	x1	5	34	417	417	0.874	mc. 0.01092

### 05 tapas-piedino ellittico 40x20 h30

tapas-elliptical glide 40x20 h30

code	finishing	q.kit	kg.x1	
134303-045	● nero/black	x4	0.0174	mc. 0.00003
134306-005	○ trasparente/transparent	x4	0.0174	mc. 0.00003

# tapas

## high table



plastic colours

- avorio/ivory ral1013
- nero/black ral9005

**Corten**  
 \*Specifica caratteristica del Corten è la variabilità nella tonalità della finitura.  
 \* A specific characteristic of Corten is the variability in the tone of the finish.

main component sizes

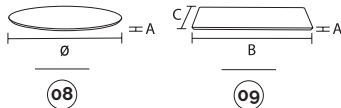
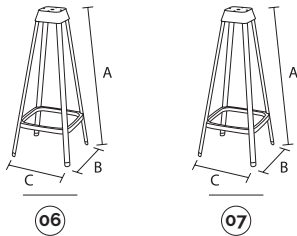

Si consigliano le seguenti misure di top:  
 The following top measures are recommended:

- high table: 590 / 690 mm

### 06 tapas-kit gambe tavolo alto con viti + supporto + poggipiedi avorio r1013

tapas-kit high table legs with screws + table frame + footrest ivory r1013

code	finishing	q.kit	q.pack	a	b	c	kg.x1	vol.x1
110303-244	● nero/black	x1	2	1085	453	453	8,0	mc. 0.02365
110304-244	● grigio/grey ig2621	x1	2	1085	453	453	8,0	mc. 0.02365
110305-244	● avorio/ivory ral 1013	x1	2	1085	453	453	8,0	mc. 0.02365
110307-244	● corten*	x1	2	1085	453	453	8,0	mc. 0.02365
110310-244	● cromato/chrome	x1	2	1085	453	453	8,0	mc. 0.02365
110303-246	● nero/black	*per esterno/outdoor	x1	2	1085	453	8,0	mc. 0.02365
110304-246	● grigio/grey ig2621	*per esterno/outdoor	x1	2	1085	453	8,0	mc. 0.02365
110305-246	● avorio/ivory ral 1013	*per esterno/outdoor	x1	2	1085	453	8,0	mc. 0.02365
110307-246	● corten*	*per esterno/outdoor	x1	2	1085	453	8,0	mc. 0.02365

### 07 tapas-kit gambe tavolo alto con viti + supporto + poggipiedi nero

tapas-kit high table legs with screws + table frame + footrest black

code	finishing	q.kit	q.pack	a	b	c	kg.x1	vol.x1
110303-245	● nero/black	x1	2	1085	453	453	8,0	mc. 0.02365
110304-245	● grigio/grey ig2621	x1	2	1085	453	453	8,0	mc. 0.02365
110305-245	● avorio/ivory ral 1013	x1	2	1085	453	453	8,0	mc. 0.02365
110307-245	● corten*	x1	2	1085	453	453	8,0	mc. 0.02365
110310-245	● cromato/chrome	x1	2	1085	453	453	8,0	mc. 0.02365
110303-247	● nero/black	*per esterno/outdoor	x1	2	1085	453	8,0	mc. 0.02365
110304-247	● grigio/grey ig2621	*per esterno/outdoor	x1	2	1085	453	8,0	mc. 0.02365
110305-247	● avorio/ivory ral 1013	*per esterno/outdoor	x1	2	1085	453	8,0	mc. 0.02365
110307-247	● corten*	*per esterno/outdoor	x1	2	1085	453	8,0	mc. 0.02365

### 08 tapas-top rotondo + viti

tapas-round top + screws

code	finishing	q.kit	q.pack	a	ø	kg.x1	vol.x1
120303-004	● nero/black	x1	5	12	590	4,8	mc. 0.0072
120303-005	● nero/black	x1	5	12	690	6,6	mc. 0.0098
120303-006	● nero/black	x1	5	12	790	8,4	mc. 0.0128
120305-004	● avorio/ivory ral 1013	x1	5	12	590	4,8	mc. 0.0072
120305-005	● avorio/ivory ral 1013	x1	5	12	690	6,6	mc. 0.0098
120305-006	● avorio/ivory ral 1013	x1	5	12	790	8,4	mc. 0.0128

### 09 tapas-top quadrato + viti

tapas-square top + screws

code	finishing	q.kit	q.pack	a	b	c	kg.x1	vol.x1
120303-008	● nero/black	x1	5	12	590	590	6,0	mc. 0.0072
120303-009	● nero/black	x1	5	12	690	690	8,2	mc. 0.0098
120303-010	● nero/black	x1	5	12	790	790	10,7	mc. 0.0128
120305-008	● avorio/ivory ral 1013	x1	5	12	590	590	6,0	mc. 0.0072
120305-009	● avorio/ivory ral 1013	x1	5	12	690	690	8,2	mc. 0.0098
120305-010	● avorio/ivory ral 1013	x1	5	12	790	790	10,7	mc. 0.0128

### 05 tapas-piedino ellittico 40x20 h30

tapas-elliptical glide 40x20 h30

code	finishing	q.kit	kg.x1
134303-045	● nero/black	x4	0,0174 mc. 0.00003
134306-005	○ trasparente/transparent	x4	0,0174 mc. 0.00003



# tapas

## low table

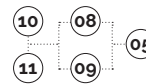
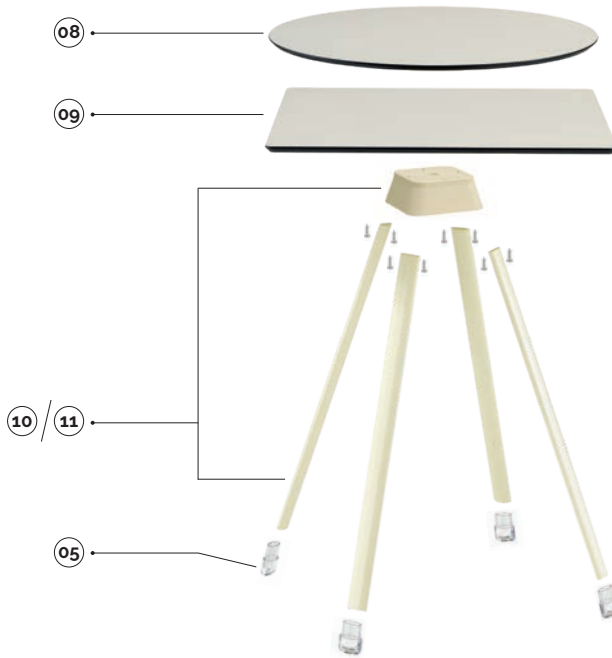

Si consigliano le seguenti misure di top:  
The following top measures are recommended:

- low table: 690/ 790 mm

plastic colours

- avorio/ivory ral1013
- nero/black ral9005

Corten  
\* Specifica caratteristica del Corten è la variabilità nella tonalità della finitura.  
\* A specific characteristic of Corten is the variability in the tone of the finish.

main component sizes

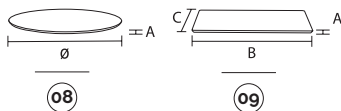
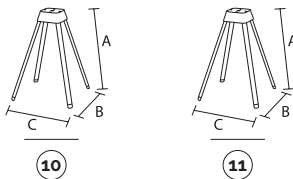

### 10 tapas-kit gambe tavolo basso con viti + supporto avorio r1013

tapas-kit low table legs with screws + table frame ivory r1013

code	finishing	q.kit	q.pack	a	b	c	kg.x1	vol.x1
110303-240	● nero/black	x1	2	730	530	530	5.11	mc. 0.01155
110304-240	● grigio/grey ig2621	x1	2	730	530	530	5.11	mc. 0.01155
110305-240	● avorio/ivory ral 1013	x1	2	730	530	530	5.11	mc. 0.01155
110307-240	● corten*	x1	2	730	530	530	5.11	mc. 0.01155
110310-240	● cromato/chrome	x1	2	730	530	530	5.11	mc. 0.01155
110303-242	● nero/black	x1	2	730	530	530	5.11	mc. 0.01155
110304-242	● grigio/grey ig2621	x1	2	730	530	530	5.11	mc. 0.01155
110305-242	● avorio/ivory ral 1013	x1	2	730	530	530	5.11	mc. 0.01155
110307-242	● corten*	x1	2	730	530	530	5.11	mc. 0.01155

### 11 tapas-kit gambe tavolo basso con viti + supporto nero

tapas-kit low table legs with screws + table frame black

code	finishing	q.kit	q.pack	a	b	c	kg.x1	vol.x1
110303-241	● nero/black	x1	2	730	530	530	5.11	mc. 0.01155
110304-241	● grigio/grey ig2621	x1	2	730	530	530	5.11	mc. 0.01155
110305-241	● avorio/ivory ral 1013	x1	2	730	530	530	5.11	mc. 0.01155
110307-241	● corten*	x1	2	730	530	530	5.11	mc. 0.01155
110310-241	● cromato/chrome	x1	2	730	530	530	5.11	mc. 0.01155
110303-243	● nero/black	x1	2	730	530	530	5.11	mc. 0.01155
110304-243	● grigio/grey ig2621	x1	2	730	530	530	5.11	mc. 0.01155
110305-243	● avorio/ivory ral 1013	x1	2	730	530	530	5.11	mc. 0.01155
110307-243	● corten*	x1	2	730	530	530	5.11	mc. 0.01155

### 08 tapas-top rotondo + viti

tapas-round top + screws

code	finishing	q.kit	q.pack	a	ø	kg.x1	vol.x1
120303-004	● nero/black	x1	5	12	590	4.8	mc. 0.0072
120303-005	● nero/black	x1	5	12	690	6.6	mc. 0.0098
120303-006	● nero/black	x1	5	12	790	8.4	mc. 0.0128
120305-004	● avorio/ivory ral 1013	x1	5	12	590	4.8	mc. 0.0072
120305-005	● avorio/ivory ral 1013	x1	5	12	690	6.6	mc. 0.0098
120305-006	● avorio/ivory ral 1013	x1	5	12	790	8.4	mc. 0.0128

### 09 tapas-top quadrato + viti

tapas-square top + screws

code	finishing	q.kit	q.pack	a	b	c	kg.x1	vol.x1
120303-008	● nero/black	x1	5	12	590	590	6.0	mc. 0.0072
120303-009	● nero/black	x1	5	12	690	690	8.2	mc. 0.0098
120303-010	● nero/black	x1	5	12	790	790	10.7	mc. 0.0128
120305-008	● avorio/ivory ral 1013	x1	5	12	590	590	6.0	mc. 0.0072
120305-009	● avorio/ivory ral 1013	x1	5	12	690	690	8.2	mc. 0.0098
120305-010	● avorio/ivory ral 1013	x1	5	12	790	790	10.7	mc. 0.0128

### 05 tapas-piedino ellittico 40x20 h30

tapas-elliptical glide 40x20 h30

code	finishing	q.kit	kg.x1
134303-045	● nero/black	x4	0.0174 mc. 0.00003
134306-005	○ trasparente/transparent	x4	0.0174 mc. 0.00003

# tapas

## coffee table

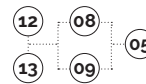
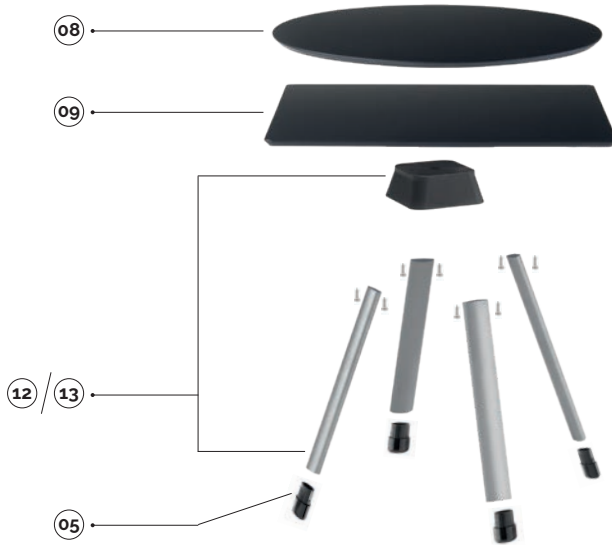

Si consigliano le seguenti misure di top:  
The following top measures are recommended:

- coffee table: 590 mm

plastic colours

- avorio/ivory ral1013
- nero/black ral9005

Corten  
\* Specifica caratteristica del Corten è la variabilità nella tonalità della finitura.  
\* A specific characteristic of Corten is the variability in the tone of the finish.

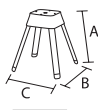
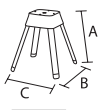

12

13

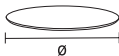

08

09



main component sizes

### 12 tapas-kit gambe tavolo caffè' con viti + supporto avorio r1013 tapas-kit coffee table legs with screws + table frame ivory r1013

code	finishing	q.kit	q.pack	a	b	c	kg.x1	vol.x1
110303-248	● nero/black	x1	2	390	353	353	2,92	mc. 0.006405
110304-248	● grigio/grey ig2621	x1	2	390	353	353	2,92	mc. 0.006405
110305-248	● avorio/ivory ral 1013	x1	2	390	353	353	2,92	mc. 0.006405
110307-248	● corten*	x1	2	390	353	353	2,92	mc. 0.006405
110310-248	● cromato/chrome	x1	2	390	353	353	2,92	mc. 0.006405
110303-250	● nero/black *per esterno/outdoor	x1	2	390	353	353	2,92	mc. 0.006405
110304-250	● grigio/grey ig2621 *per esterno/outdoor	x1	2	390	353	353	2,92	mc. 0.006405
110305-250	● avorio/ivory ral 1013 *per esterno/outdoor	x1	2	390	353	353	2,92	mc. 0.006405
110307-250	● corten* *per esterno/outdoor	x1	2	390	353	353	2,92	mc. 0.006405

### 13 tapas-kit gambe tavolo caffè' con viti + supporto nero tapas-kit coffee table legs with screws + table frame black

code	finishing	q.kit	q.pack	a	b	c	kg.x1	vol.x1
110303-249	● nero/black	x1	2	390	353	353	2,92	mc. 0.006405
110304-249	● grigio/grey ig2621	x1	2	390	353	353	2,92	mc. 0.006405
110305-249	● avorio/ivory ral 1013	x1	2	390	353	353	2,92	mc. 0.006405
110307-249	● corten*	x1	2	390	353	353	2,92	mc. 0.006405
110310-249	● cromato/chrome	x1	2	390	353	353	2,92	mc. 0.006405
110303-251	● nero/black *per esterno/outdoor	x1	2	390	353	353	2,92	mc. 0.006405
110304-251	● grigio/grey ig2621 *per esterno/outdoor	x1	2	390	353	353	2,92	mc. 0.006405
110305-251	● avorio/ivory ral 1013 *per esterno/outdoor	x1	2	390	353	353	2,92	mc. 0.006405
110307-251	● corten* *per esterno/outdoor	x1	2	390	353	353	2,92	mc. 0.006405

### 08 tapas-top rotondo + viti tapas-round top + screws

code	finishing	q.kit	q.pack	a	ø	kg.x1	vol.x1
120303-004	● nero/black	x1	5	12	590	4,8	mc. 0.0072
120303-005	● nero/black	x1	5	12	690	6,6	mc. 0.0098
120303-006	● nero/black	x1	5	12	790	8,4	mc. 0.0128
120305-004	● avorio/ivory ral 1013	x1	5	12	590	4,8	mc. 0.0072
120305-005	● avorio/ivory ral 1013	x1	5	12	690	6,6	mc. 0.0098
120305-006	● avorio/ivory ral 1013	x1	5	12	790	8,4	mc. 0.0128

### 09 tapas-top quadrato + viti tapas-square top + screws

code	finishing	q.kit	q.pack	a	b	c	kg.x1	vol.x1
120303-008	● nero/black	x1	5	12	590	590	6,0	mc. 0.0072
120303-009	● nero/black	x1	5	12	690	690	8,2	mc. 0.0098
120303-010	● nero/black	x1	5	12	790	790	10,7	mc. 0.0128
120305-008	● avorio/ivory ral 1013	x1	5	12	590	590	6,0	mc. 0.0072
120305-009	● avorio/ivory ral 1013	x1	5	12	690	690	8,2	mc. 0.0098
120305-010	● avorio/ivory ral 1013	x1	5	12	790	790	10,7	mc. 0.0128

### 05 tapas-piedino ellittico 40x20 h30 tapas-elliptical glide 40x20 h30

code	finishing	q.kit	kg.x1
134303-045	● nero/black	x4	0,0174 mc. 0.00003
134306-005	○ trasparente/transparent	x4	0,0174 mc. 0.00003



# tapas

4-legs/metal shell



14 15 16

Corten ● \*Specifica caratteristica del Corten è la variabilità nella tonalità della finitura.  
\* A specific characteristic of Corten is the variability in the tone of the finish.

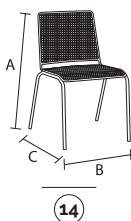

main component sizes

**14** tapas-4 gambe con scocca in rete  
tapas-4 legs with expanded metal shell

code	finishing		q.kit	q.pack	a	b	c	kg.x1	vol.x1
110105-367	● avorio/ivory	rat.1013 *per esterno/outdoor	x1	1	805	535	580	5,6	mc. 0.024
110107-367	● corten*	*per esterno/outdoor	x1	1	805	535	580	5,6	mc. 0.024

**15** confezione puntali tondi d.18 neri  
black inner round caps d.18 package

code	finishing	q.kit	q.pack
137003-072	● nero/black	x4	200

**16** paracolpi testa piatta duro 12x3,8x6x9 neutro  
flat head buffer 12x3,8x6x9 neutral

code	finishing	q.kit
134006-100	○ neutro/neutral	x4

# tapas

stool/metal shell



17 15 16

Corten ● \*Specifica caratteristica del Corten è la variabilità nella tonalità della finitura.  
\* A specific characteristic of Corten is the variability in the tone of the finish.

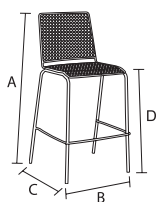

17

main component sizes

**17** tapas-sgabello h750 con scocca in rete  
tapas-stool h750 with expanded metal shell

code	finishing		q.kit	q.pack	a	b	c	d	kg.x1	vol.x1
110105-374	● avorio/ivory	ral.1013 'per esterno/outdoor	x1	1	1100	540	540	750	7,8	mc. 0,048
110107-374	● corten*	'per esterno/outdoor	x1	1	1100	540	540	750	7,8	mc. 0,048

**15** confezione puntali tondi d.18 neri  
black inner round caps d.18 package

code	finishing	q.kit	q.pack
137003-072	● nero/black	x4	200

**16** paracolpi testa piatta duro 12x3,8x6x9 neutro  
flat head buffer 12x3,8x6x9 neutral

code	finishing	q.kit
134006-100	○ neutro/neutral	x4

# tapas

slide/metal shell

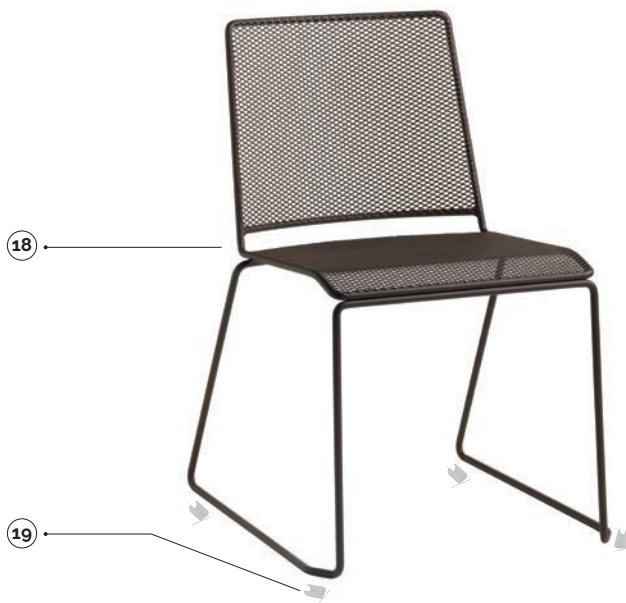

18 19

Corten ● \*Specifica caratteristica del Corten è la variabilità nella tonalità della finitura.  
\* A specific characteristic of Corten is the variability in the tone of the finish.

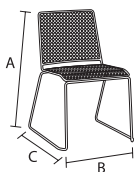

18

main component sizes

**18** tapas-telaio a slitta in tondino d.12 con scocca in rete  
tapas-slide wire frame d.12 with expanded metal shell

code	finishing		q.kit	q.pack	a	b	c	kg.x1	vol.x1
110505-504	● avorio/ivory	ral1013 *per esterno/outdoor	x1	1	805	520	595	7.7	mc. 0.036
110507-504	● corten*	*per esterno/outdoor	x1	1	805	520	595	7.7	mc. 0.036

**19** confezione di basi a pinza antirotazione per tondino colore neutro  
neutral clips base for wire d.11 package

code	finishing	q.kit	q.pack
137006-070	○ neutro/neutral	x4	200

