

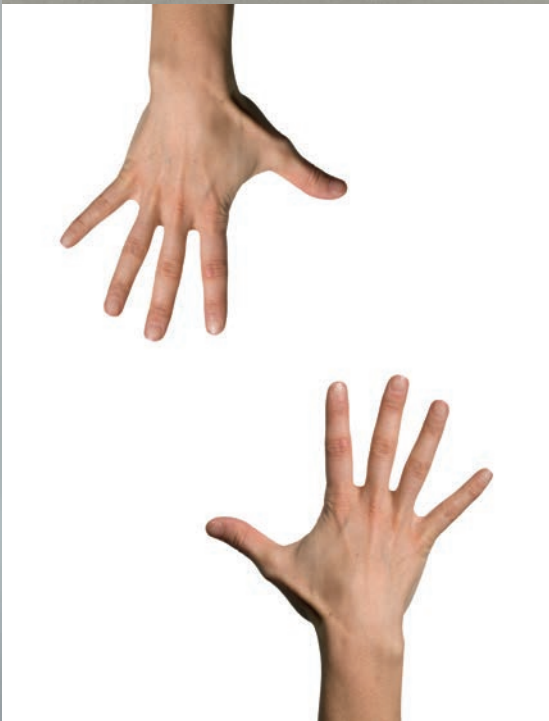

BEYOND | **Solutions**





**aba**



# aba



\*left arm for writing tablet available

slide  
slide w/armrests  
slide w/writing tablet  
stool

4 legs  
4 legs w/armrest  
4 legs w/writing tablet

swivel  
swivel w/armrest

bench



BIFMA TEST

EN 16139



tools



certification



brochure



video

aba showing

features



designed by:  
r&d albacomponents



trolley  
available



Sedia robusta, caratterizzata da una **perfetta impilabilità e da una intercambiabilità inconfondibili.**

Ogni singolo componente in plastica, può essere assemblato con tutti i telai disponibili in gamma, combinando con grande semplicità le diverse versioni della stessa seduta.

**Certificata CATAS e BIFMA.**

*A sturdy chair, characterized by a **perfect stacking and high interchangeability.***

*Each of the individual plastic components can be assembled with all the frames available in the range, enabling many different versions of the same seat to be created with ease.*

**CATAS and BIFMA certified**



# aba

slide w/writing tablet



plastic colours

- rosso/red 527
- nero/black
- grigio/gray 7035
- bianco/white 218
- viola/violet 145
- blu/blue 5023
- verde/pastel green 6019

aba-carrello portasedie con accessori  
aba-trolley for chairs with accessories

| code       | finishing    |
|------------|--------------|
| 110803-372 | ● nero/black |

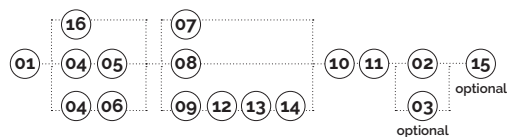

main component sizes

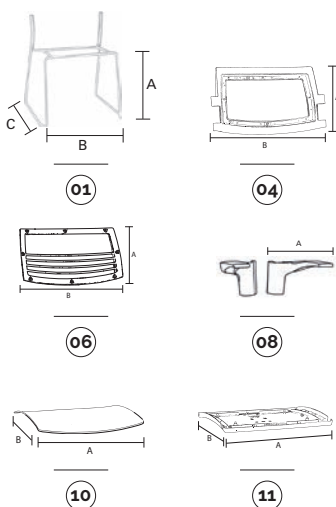

optionals

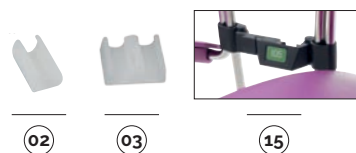

**01** aba-telaio a slitta in tondino d.12  
aba-slide frame wire d.12

| code       | finishing        | q.kit | q.pack | a   | b   | c   | kg.x1 | vol.x1    |
|------------|------------------|-------|--------|-----|-----|-----|-------|-----------|
| 111810-036 | ● cromato/chrome | x1    | 60     | 440 | 570 | 485 | 4,70  | mc. 0.035 |

**02** confezione di basi a pinza antirrotazione per tondino colore neutro  
neutral clips base for wire d.11 package

| code       | finishing        | q.kit | q.pack |
|------------|------------------|-------|--------|
| 137006-070 | ○ neutro/neutral | x4    | 200    |

**03** base piana a pinza doppia  
double flat clip base

| code       | finishing        | q.kit |
|------------|------------------|-------|
| 134006-021 | ○ neutro/neutral | x4    |

**04** aba-telaio schienale esterno portante in plastica  
aba-outer plastic back

| code       | finishing    | q.kit | q.pack | a   | b   | kg.x1 | vol.x1    |
|------------|--------------|-------|--------|-----|-----|-------|-----------|
| 132103-065 | ● nero/black | x1    | 20     | 320 | 460 | 0,51  | mc. 0.005 |

**06** aba-cornice schienale in plastica per rete  
aba-frame back in plastic mesh

| code       | finishing    | q.kit | q.pack | a   | b   | kg.x1 | vol.x1     |
|------------|--------------|-------|--------|-----|-----|-------|------------|
| 132103-063 | ● nero/black | x1    | 25     | 250 | 420 | 0,25  | mc. 0.0025 |

**08** aba-coppia braccioli destro-sinistro plastica  
aba-pair arm right-left plastic

| code       | finishing    | q.kit | q.pack | a   |
|------------|--------------|-------|--------|-----|
| 131703-055 | ● nero/black | x1    | 20     | 190 |

**10** aba-sedile plastica colorato a vista (tappezzabile)  
aba-plastic seat colored (to be upholstered)

| code       | finishing    | q.kit | q.pack | a   | b   | kg.x1 | vol.x1   |
|------------|--------------|-------|--------|-----|-----|-------|----------|
| 132203-070 | ● nero/black | x1    | 10     | 455 | 470 | 1,32  | mc. 0.01 |

**11** aba-sottosedile plastica colorato a vista+viti  
aba-outer plastic seat colored+screws

| code       | finishing    | q.kit | q.pack | a   | b   | kg.x1 | vol.x1    |
|------------|--------------|-------|--------|-----|-----|-------|-----------|
| 132203-071 | ● nero/black | x1    | 20     | 430 | 410 | 0,54  | mc. 0.005 |

**15** aba-aggancio laterale maschio+femmina in plastica  
aba-plastic linking device male+female

| code       | finishing    | q.kit |
|------------|--------------|-------|
| 134003-137 | ● nero/black | x1    |



for all colour codes, see page 59

# aba

## slide/tablet accessories

main component sizes

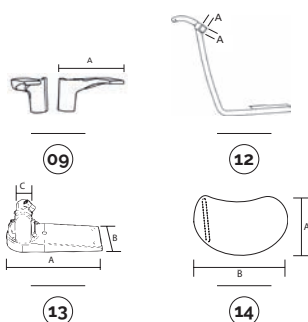

### 09 aba-coppia braccioli destro-sinistro plastica per tavoletta aba-pair arm right-left plastic for tablet

| code       | finishing    | q.kit | q.pack | a   |
|------------|--------------|-------|--------|-----|
| 131703-056 | ● nero/black | x1    | 20     | 190 |

### 12 aba-telaio in ferro per aggancio tavoletta+viti aba-metal frame with table hook + screws

| code       | finishing                                 | q.kit | q.pack | kg.x1 | vol.x1         |
|------------|---|-------|--------|-------|----------------|
| 111703-054 | ● nero/black destro/right - slitta/slide  | x1    | 10     | 15x15 | 0,60 mc. 0.002 |
| 111703-055 | ● nero/black sinistro/left - slitta/slide | x1    | 10     | 15x15 | 0,60 mc. 0.002 |

### 13 spt2-snodo per tavoletta in plastica spt2-mechanism for writing tablet in plastic

| code       | finishing    | q.kit | q.pack | a   | b  | c     | kg.x1 | vol.x1     |
|------------|--------------|-------|--------|-----|----|-------|-------|------------|
| 134003-039 | ● nero/black | x1    | 20     | 180 | 66 | 15x15 | 0,35  | mc. 0.0006 |

### 14 bean-tavoletta in plastica spessore 16 bean-writing tablet in plastic thickness 16 mm

| code       | finishing    | q.kit | q.pack | a   | b   | kg.x1 | vol.x1    |
|------------|--------------|-------|--------|-----|-----|-------|-----------|
| 134003-044 | ● nero/black | x1    | 20     | 235 | 370 | 0,40  | mc. 0.002 |



for writing tablet options, see page 192/193

## slide/backrest options

main component sizes

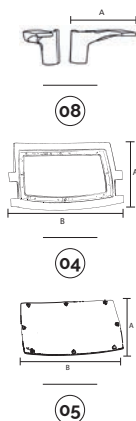

### 08 aba-coppia braccioli destro-sinistro plastica aba-pair arm right-left plastic

| code       | finishing    | q.kit | q.pack | a   |
|------------|--------------|-------|--------|-----|
| 131703-055 | ● nero/black | x1    | 20     | 190 |

### 04 aba-telaio schienale esterno portante in plastica aba-outer plastic back

| code       | finishing    | q.kit | q.pack | a   | b   | kg.x1 | vol.x1     |
|------------|--------------|-------|--------|-----|-----|-------|------------|
| 132103-065 | ● nero/black | x1    | 20     | 320 | 460 | 0,51  | mc. 0.0005 |

### 05 aba-pannello schienale in plastica da tappezzare aba-frame back in plastic for upholstery

| code       | finishing    | q.kit | q.pack | a   | b   | kg.x1 | vol.x1     |
|------------|--------------|-------|--------|-----|-----|-------|------------|
| 132103-064 | ● nero/black | x1    | 25     | 250 | 420 | 0,37  | mc. 0.0025 |

CERTIFIED BY  
**BIFMA**  
**CATAS**

### 08 aba-coppia braccioli destro-sinistro plastica aba-pair arm right-left plastic

| code       | finishing       | q.kit | q.pack | a   |
|------------|-----------------|-------|--------|-----|
| 131702-055 | ● rosso/red 527 | x1    | 20     | 190 |

### 16 aba-schienale plastica colorato a vista aba-plastic back colored

| code       | finishing       | q.kit | q.pack | a   | b   | kg.x1 | vol.x1    |
|------------|-----------------|-------|--------|-----|-----|-------|-----------|
| 132102-067 | ● rosso/red 527 | x1    | 20     | 320 | 460 | 0,63  | mc. 0.009 |

main component sizes



main component sizes



### 07 aba-coppia inserti schienale destro-sinistro plastica aba-back inserts right-left plastic

| code       | finishing       | q.kit | q.pack |
|------------|-----------------|-------|--------|
| 132115-066 | ● blu/blue 5023 | x1    | 50     |

### 16 aba-schienale plastica colorato a vista aba-plastic back colored

| code       | finishing       | q.kit | q.pack | a   | b   | kg.x1 | vol.x1    |
|------------|-----------------|-------|--------|-----|-----|-------|-----------|
| 132115-067 | ● blu/blue 5023 | x1    | 20     | 320 | 460 | 0,63  | mc. 0.009 |

# aba

## stool

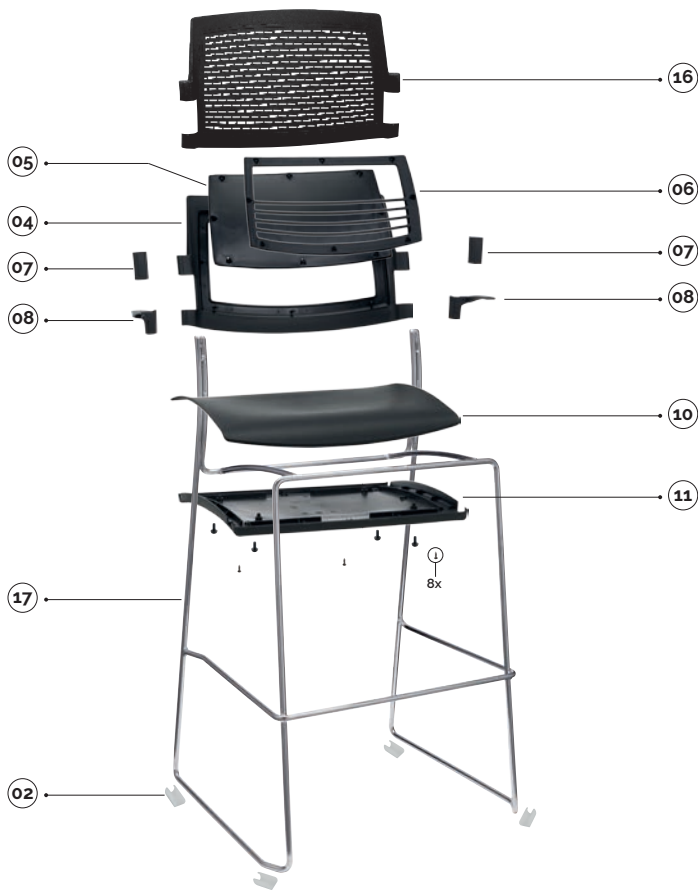

plastic colours

- rosso/red 527
- nero/black
- grigio/gray 7035
- bianco/white 218
- viola/violet 145
- blu/blue 5023
- verde/pastel green 6019

main component sizes

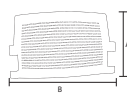
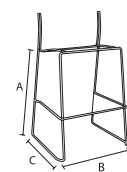

17

16



07

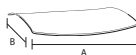

10

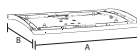

11



02



03

optional

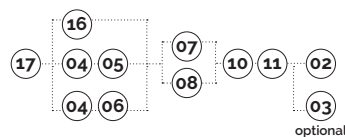

### 17 aba-sgabello alto in tondino cromato senza tappi aba-wire high bar stool without caps

| code       | finishing        | q.kit | q.pack | a   | b   | c   | kg.x1 | vol.x1    |
|------------|------------------|-------|--------|-----|-----|-----|-------|-----------|
| 111810-037 | ● cromato/chrome | x1    | 40     | 685 | 500 | 510 | 4,70  | mc. 0.063 |

### 02 confezione di basi a pinza antirrotazione per tondino colore neutro neutral clips base for wire d.11 package

| code       | finishing        | q.kit | q.pack |
|------------|------------------|-------|--------|
| 137006-070 | ○ neutro/neutral | x4    | 200    |

### 03 base piana a pinza doppia double flat clip base

| code       | finishing        | q.kit |
|------------|------------------|-------|
| 134006-021 | ○ neutro/neutral | x4    |

### 16 aba-schienale plastica colorato a vista aba-plastic back colored

| code       | finishing          | q.kit | q.pack | a   | b   | kg.x1 | vol.x1    |
|------------|--------------------|-------|--------|-----|-----|-------|-----------|
| 132105-067 | ○ bianco/white 218 | x1    | 20     | 320 | 460 | 0,63  | mc. 0.009 |

### 07 aba-coppia inserti schienale destro-sinistro plastica aba-pair back inserts right-left plastic

| code       | finishing          | q.kit | q.pack |
|------------|--------------------|-------|--------|
| 132105-066 | ○ bianco/white 218 | x1    | 50     |

### 10 aba-sedile plastica colorato a vista (tappizzabile) aba-plastic seat colored (to be upholstered)

| code       | finishing          | q.kit | q.pack | a   | b   | kg.x1 | vol.x1   |
|------------|--------------------|-------|--------|-----|-----|-------|----------|
| 132205-070 | ○ bianco/white 218 | x1    | 10     | 455 | 470 | 1,32  | mc. 0.01 |

### 11 aba-sottosedile plastica colorato a vista+viti aba-outer plastic seat colored+screws

| code       | finishing          | q.kit | q.pack | a   | b   | kg.x1 | vol.x1    |
|------------|--------------------|-------|--------|-----|-----|-------|-----------|
| 132205-071 | ○ bianco/white 218 | x1    | 20     | 430 | 410 | 0,54  | mc. 0.005 |



for all colour codes, see page 59

# aba

## stool/backrest options

main component sizes

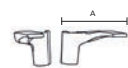

08

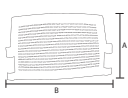

16



**08** aba-coppia braccioli destro-sinistro plastica  
aba-pair arm right-left plastic

| code       | finishing   |     | q.kit | q.pack | a   |
|------------|-------------|-----|-------|--------|-----|
| 131702-055 | ● rosso/red | 527 | x1    | 20     | 190 |

**16** aba-schienale plastica colorato a vista  
aba-plastic back colored

| code       | finishing   |     | q.kit | q.pack | a   | b   | kg.x1 | vol.x1    |
|------------|-------------|-----|-------|--------|-----|-----|-------|-----------|
| 132102-067 | ● rosso/red | 527 | x1    | 20     | 320 | 460 | 0,63  | mc. 0,009 |

main component sizes



07

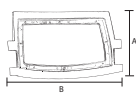

04

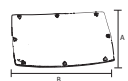

05



**07** aba-coppia inserti schienale destro-sinistro plastica  
aba-pair back inserts right-left plastic

| code       | finishing    |  | q.kit | q.pack |
|------------|--------------|--|-------|--------|
| 132103-066 | ● nero/black |  | x1    | 50     |

**04** aba-telaio schienale esterno portante in plastica  
aba-outer plastic back

| code       | finishing    |  | q.kit | q.pack | a   | b   | kg.x1 | vol.x1    |
|------------|--------------|--|-------|--------|-----|-----|-------|-----------|
| 132103-065 | ● nero/black |  | x1    | 20     | 320 | 460 | 0,51  | mc. 0,005 |

**05** aba-pannello schienale in plastica da tappezzare  
aba-frame back in plastic for upholstery

| code       | finishing    |  | q.kit | q.pack | a   | b   | kg.x1 | vol.x1     |
|------------|--------------|--|-------|--------|-----|-----|-------|------------|
| 132103-064 | ● nero/black |  | x1    | 25     | 250 | 420 | 0,37  | mc. 0,0025 |

main component sizes



07

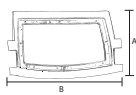

04

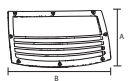

06



**07** aba-coppia inserti schienale destro-sinistro plastica  
aba-pair back inserts right-left plastic

| code       | finishing    |  | q.kit | q.pack |
|------------|--------------|--|-------|--------|
| 132103-066 | ● nero/black |  | x1    | 50     |

**04** aba-telaio schienale esterno portante in plastica  
aba-outer plastic back

| code       | finishing    |  | q.kit | q.pack | a   | b   | kg.x1 | vol.x1    |
|------------|--------------|--|-------|--------|-----|-----|-------|-----------|
| 132103-065 | ● nero/black |  | x1    | 20     | 320 | 460 | 0,51  | mc. 0,005 |

**06** aba-cornice schienale in plastica per rete  
aba-frame back in plastic mesh

| code       | finishing    |  | q.kit | q.pack | a   | b   | kg.x1 | vol.x1     |
|------------|--------------|--|-------|--------|-----|-----|-------|------------|
| 132103-063 | ● nero/black |  | x1    | 25     | 250 | 420 | 0,25  | mc. 0,0025 |

# aba

4-legs w/writing tablet



plastic colours

- rosso/red 527
- nero/black
- grigio/gray 7035
- bianco/white 218
- viola/violet 145
- blu/blue 5023
- verde/pastel green 6019

aba-carrello portasedie con accessori  
aba-trolley for chairs with accessories

| code       | finishing    |
|------------|--------------|
| 110803-372 | ● nero/black |

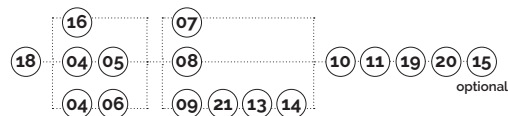

main component sizes

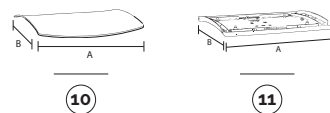
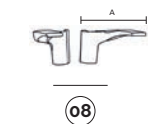
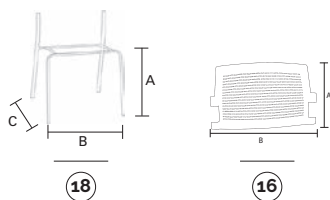

optionals



| code       | finishing        | q.kit | q.pack | a   | b   | c   | kg.x1 | vol.x1    |
|------------|------------------|-------|--------|-----|-----|-----|-------|-----------|
| 111803-035 | ● nero/black     | x1    | 80     | 440 | 530 | 510 | 3,70  | mc. 0.035 |
| 111804-035 | ● grigio/grey    | x1    | 80     | 440 | 530 | 510 | 3,70  | mc. 0.035 |
| 111810-035 | ● cromato/chrome | x1    | 80     | 440 | 530 | 510 | 3,70  | mc. 0.035 |

| code       | finishing    | q.kit |
|------------|--------------|-------|
| 134203-014 | ● nero/black | x2    |

| code       | finishing    | q.kit |
|------------|--------------|-------|
| 134203-015 | ● nero/black | x2    |

| code       | finishing    | q.kit | q.pack | a   | b   | kg.x1 | vol.x1    |
|------------|--------------|-------|--------|-----|-----|-------|-----------|
| 132103-067 | ● nero/black | x1    | 20     | 320 | 460 | 0,63  | mc. 0.009 |

| code       | finishing    | q.kit | q.pack | a   |
|------------|--------------|-------|--------|-----|
| 131703-055 | ● nero/black | x1    | 20     | 190 |

| code       | finishing    | q.kit | q.pack | a   | b   | kg.x1 | vol.x1   |
|------------|--------------|-------|--------|-----|-----|-------|----------|
| 132203-070 | ● nero/black | x1    | 10     | 455 | 470 | 1,32  | mc. 0.01 |

| code       | finishing    | q.kit | q.pack | a   | b   | kg.x1 | vol.x1    |
|------------|--------------|-------|--------|-----|-----|-------|-----------|
| 132203-071 | ● nero/black | x1    | 20     | 430 | 410 | 0,54  | mc. 0.005 |

| code       | finishing    | q.kit |
|------------|--------------|-------|
| 134003-137 | ● nero/black | x1    |



for all colour codes, see page 59



# aba

## 4-legs/tablet accessories

main component sizes

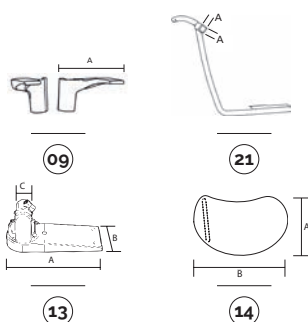

**09** aba-coppia braccioli destro-sinistro plastica per tavoletta  
aba-pair arm right-left plastic for tablet

| code       | finishing    | q.kit | q.pack | a   |
|------------|--------------|-------|--------|-----|
| 131703-056 | ● nero/black | x1    | 20     | 190 |

**21** aba-telaio in ferro per aggancio tavoletta+viti  
aba-metal frame whit table hook + screws

| code       | finishing                                   | q.kit | q.pack | kg.x1 | vol.x1         |
|------------|---|-------|--------|-------|----------------|
| 111703-050 | ● nero/black destro/right - 4 gambe/4-legs  | x1    | 10     | 15x15 | 0,60 mc. 0.002 |
| 111703-053 | ● nero/black sinistro/left - 4 gambe/4-legs | x1    | 10     | 15x15 | 0,60 mc. 0.002 |

**13** spt2-snodo per tavoletta in plastica  
spt2-mechanism for writing tablet in plastic

| code       | finishing    | q.kit | q.pack | a   | b  | c     | kg.x1 | vol.x1     |
|------------|--------------|-------|--------|-----|----|-------|-------|------------|
| 134003-039 | ● nero/black | x1    | 20     | 180 | 66 | 15x15 | 0,35  | mc. 0.0006 |

**14** bean-tavoletta in plastica spessore 16  
bean-writing tablet in plastic thickness 16 mm

| code       | finishing    | q.kit | q.pack | a   | b   | kg.x1 | vol.x1    |
|------------|--------------|-------|--------|-----|-----|-------|-----------|
| 134003-044 | ● nero/black | x1    | 20     | 235 | 370 | 0,40  | mc. 0.002 |



for writing tablet options, see page 192/193

## 4-legs/backrest options

main component sizes

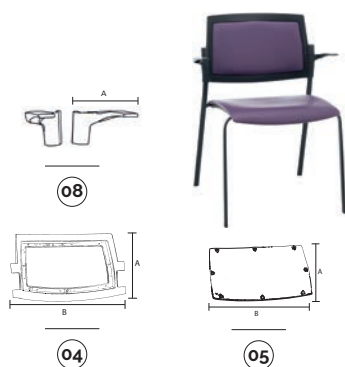

**08** aba-coppia braccioli destro-sinistro plastica  
aba-pair arm right-left plastic

| code       | finishing    | q.kit | q.pack | a   |
|------------|--------------|-------|--------|-----|
| 131703-055 | ● nero/black | x1    | 20     | 190 |

**04** aba-telaio schienale esterno portante in plastica  
aba-outer plastic back

| code       | finishing    | q.kit | q.pack | a   | b   | kg.x1 | vol.x1    |
|------------|--------------|-------|--------|-----|-----|-------|-----------|
| 132103-065 | ● nero/black | x1    | 20     | 320 | 460 | 0,51  | mc. 0.005 |

**05** aba-pannello schienale in plastica da tappezzare  
aba-frame back in plastic for upholstery

| code       | finishing    | q.kit | q.pack | a   | b   | kg.x1 | vol.x1     |
|------------|--------------|-------|--------|-----|-----|-------|------------|
| 132103-064 | ● nero/black | x1    | 25     | 250 | 420 | 0,37  | mc. 0.0025 |

main component sizes



**08** aba-coppia braccioli destro-sinistro plastica  
aba-pair arm right-left plastic

| code       | finishing    | q.kit | q.pack | a   |
|------------|--------------|-------|--------|-----|
| 131703-055 | ● nero/black | x1    | 20     | 190 |

**04** aba-telaio schienale esterno portante in plastica  
aba-outer plastic back

| code       | finishing    | q.kit | q.pack | a   | b   | kg.x1 | vol.x1    |
|------------|--------------|-------|--------|-----|-----|-------|-----------|
| 132103-065 | ● nero/black | x1    | 20     | 320 | 460 | 0,51  | mc. 0.005 |

**06** aba-cornice schienale in plastica per rete  
aba-frame back in plastic mesh

| code       | finishing    | q.kit | q.pack | a   | b   | kg.x1 | vol.x1     |
|------------|--------------|-------|--------|-----|-----|-------|------------|
| 132103-063 | ● nero/black | x1    | 25     | 250 | 420 | 0,25  | mc. 0.0025 |

main component sizes

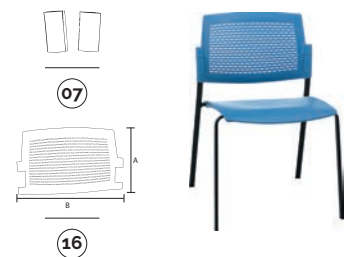

**07** aba-coppia inserti schienale destro-sinistro plastica  
aba-pair back inserts right-left plastic

| code       | finishing  | q.kit | q.pack |
|------------|------------|-------|--------|
| 132115-066 | ● blu/blue | x1    | 50     |

**16** aba-schienale plastica colorato a vista  
aba-plastic back colored

| code       | finishing  | q.kit | q.pack | a   | b   | kg.x1 | vol.x1    |
|------------|------------|-------|--------|-----|-----|-------|-----------|
| 132115-067 | ● blu/blue | x1    | 20     | 320 | 460 | 0,63  | mc. 0.009 |

# aba

## swivel



plastic colours

- rosso/red 527
- nero/black
- grigio/gray 7035
- bianco/white 218
- viola/violet 145
- blu/blue 5023
- verde/pastel green 6019

main component sizes

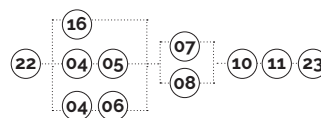
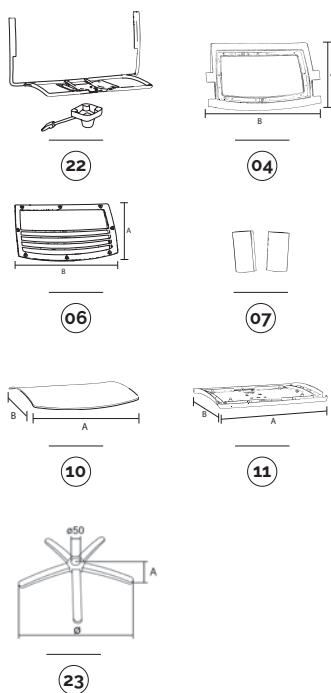

**22** aba-telaio girevole gas c/blocchetto  
aba-swivel frame gas with lever

| code       | finishing    | q.kit | q.pack | kg.x1 | vol.x1   |
|------------|--------------|-------|--------|-------|----------|
| 111803-036 | ● nero/black | x1    | 100    | 3,22  | mc. 0.02 |

**04** aba-telaio schienale esterno portante in plastica  
aba-outer plastic back

| code       | finishing    | q.kit | q.pack | a   | b   | kg.x1 | vol.x1    |
|------------|--------------|-------|--------|-----|-----|-------|-----------|
| 132103-065 | ● nero/black | x1    | 20     | 320 | 460 | 0,51  | mc. 0.005 |

**06** aba-cornice schienale in plastica per rete  
aba-frame back in plastic mesh

| code       | finishing    | q.kit | q.pack | a   | b   | kg.x1 | vol.x1     |
|------------|--------------|-------|--------|-----|-----|-------|------------|
| 132103-063 | ● nero/black | x1    | 25     | 250 | 420 | 0,25  | mc. 0.0025 |

**07** aba-coppia inserti schienale destro-sinistro plastica  
aba-pair back inserts right-left plastic

| code       | finishing    | q.kit | q.pack |
|------------|--------------|-------|--------|
| 132103-066 | ● nero/black | x1    | 50     |

**10** aba-sedile plastica colorato a vista (tappezzabile)  
aba-plastic seat colored (to be upholstered)

| code       | finishing    | q.kit | q.pack | a   | b   | kg.x1 | vol.x1   |
|------------|--------------|-------|--------|-----|-----|-------|----------|
| 132203-070 | ● nero/black | x1    | 10     | 455 | 470 | 1,32  | mc. 0.01 |

**11** aba-sottosedile plastica colorato a vista+viti  
aba-outer plastic seat colored+screws

| code       | finishing    | q.kit | q.pack | a   | b   | kg.x1 | vol.x1    |
|------------|--------------|-------|--------|-----|-----|-------|-----------|
| 132203-071 | ● nero/black | x1    | 20     | 430 | 410 | 0,54  | mc. 0.005 |

**23** b40 base in metallo d.640 con coprisaldatura  
b40 metal base d.640 with cover welding

| code       | finishing        | q.kit | q.pack | a  | ø   | kg.x1 | vol.x1    |
|------------|------------------|-------|--------|----|-----|-------|-----------|
| 110210-027 | ● cromato/chrome | x1    | 5      | 60 | 640 | 2,85  | mc. 0.014 |



for all colour codes, see page 59

# aba

## swivel/backrest options

main component sizes

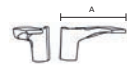

08

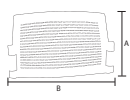

16



**08** aba-coppia braccioli destro-sinistro plastica  
aba-pair arm right-left plastic

| code       | finishing   |     | q.kit | q.pack | a   |
|------------|-------------|-----|-------|--------|-----|
| 131702-055 | ● rosso/red | 527 | x1    | 20     | 190 |

**16** aba-schienale plastica colorato a vista  
aba-plastic back colored

| code       | finishing   |     | q.kit | q.pack | a   | b   | kg.x1 | vol.x1    |
|------------|-------------|-----|-------|--------|-----|-----|-------|-----------|
| 132102-067 | ● rosso/red | 527 | x1    | 20     | 320 | 460 | 0,63  | mc. 0,009 |

main component sizes

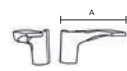

08

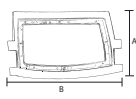

04

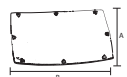

05



**08** aba-coppia braccioli destro-sinistro plastica  
aba-pair arm right-left plastic

| code       | finishing    |  | q.kit | q.pack | a   |
|------------|--------------|--|-------|--------|-----|
| 131703-055 | ● nero/black |  | x1    | 20     | 190 |

**04** aba-telaio schienale esterno portante in plastica  
aba-outer plastic back

| code       | finishing    |  | q.kit | q.pack | a   | b   | kg.x1 | vol.x1    |
|------------|--------------|--|-------|--------|-----|-----|-------|-----------|
| 132103-065 | ● nero/black |  | x1    | 20     | 320 | 460 | 0,51  | mc. 0,005 |

**05** aba-pannello schienale in plastica da tappezzare  
aba-frame back in plastic for upholstery

| code       | finishing    |  | q.kit | q.pack | a   | b   | kg.x1 | vol.x1     |
|------------|--------------|--|-------|--------|-----|-----|-------|------------|
| 132103-064 | ● nero/black |  | x1    | 25     | 250 | 420 | 0,37  | mc. 0,0025 |

main component sizes



07

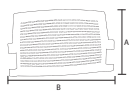

16



**07** aba-coppia inserti schienale destro-sinistro plastica  
aba-pair back inserts right-left plastic

| code       | finishing  |      | q.kit | q.pack |
|------------|------------|------|-------|--------|
| 132115-066 | ● blu/blue | 5023 | x1    | 50     |

**16** aba-schienale plastica colorato a vista  
aba-plastic back colored

| code       | finishing  |      | q.kit | q.pack | a   | b   | kg.x1 | vol.x1    |
|------------|------------|------|-------|--------|-----|-----|-------|-----------|
| 132115-067 | ● blu/blue | 5023 | x1    | 20     | 320 | 460 | 0,63  | mc. 0,009 |

# aba

## bench



plastic colours

- rosso/red 527
- nero/black
- grigio/gray 7035
- bianco/white 218
- viola/violet 145
- blu/blue 5023
- verde/pastel green 6019

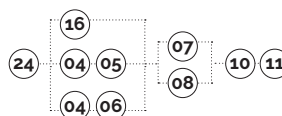

main component sizes

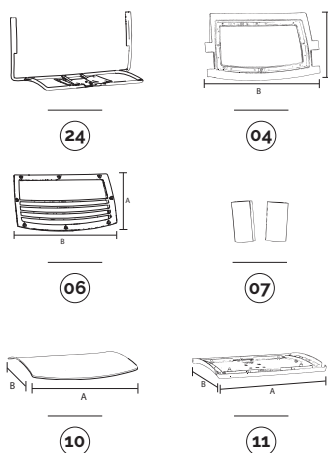

### 24 aba-telaio per panca aba-bench frame

| code       | finishing    | q.kit | q.pack | kg.x1 | vol.x1   |
|------------|--------------|-------|--------|-------|----------|
| 110703-048 | ● nero/black | x1    | 100    | 2,90  | mc. 0.02 |

### 04 aba-telaio schienale esterno portante in plastica aba-outer plastic back

| code       | finishing    | q.kit | q.pack | a   | b   | kg.x1 | vol.x1    |
|------------|--------------|-------|--------|-----|-----|-------|-----------|
| 132103-065 | ● nero/black | x1    | 20     | 320 | 460 | 0,51  | mc. 0.005 |

### 06 aba-cornice schienale in plastica per rete aba-frame back in plastic mesh

| code       | finishing    | q.kit | q.pack | a   | b   | kg.x1 | vol.x1     |
|------------|--------------|-------|--------|-----|-----|-------|------------|
| 132103-063 | ● nero/black | x1    | 25     | 250 | 420 | 0,25  | mc. 0.0025 |

### 07 aba-coppia inserti schienale destro-sinistro plastica aba-pair back inserts right-left plastic

| code       | finishing    | q.kit | q.pack |
|------------|--------------|-------|--------|
| 132103-066 | ● nero/black | x1    | 50     |

### 10 aba-sedile plastica colorato a vista (tappizzabile) aba-plastic seat colored (to be upholstered)

| code       | finishing    | q.kit | q.pack | a   | b   | kg.x1 | vol.x1   |
|------------|--------------|-------|--------|-----|-----|-------|----------|
| 132203-070 | ● nero/black | x1    | 10     | 455 | 470 | 1,32  | mc. 0.01 |

### 11 aba-sottosedile plastica colorato a vista+viti aba-outer plastic seat colored+screws

| code       | finishing    | q.kit | q.pack | a   | b   | kg.x1 | vol.x1    |
|------------|--------------|-------|--------|-----|-----|-------|-----------|
| 132203-071 | ● nero/black | x1    | 20     | 430 | 410 | 0,54  | mc. 0.005 |

for the bench components, see page 201



for all colour codes, see page 59

optionals

OPTIONAL  
bench  
connector

E-USB  
NEW  
bench plug



JIM NEW  
bench leg

APOLL  
bench arm



plastic

90GM  
bench leg

90GF  
bench leg

100GM  
bench leg

200GM  
bench leg

PIONEER  
bench arm



metal

CUT  
bench leg

SLIM  
bench leg

CUT  
bench arm

SLIM  
bench arm



aluminium



### plastic colour codes



**16** schienale in plastica  
plastic backrest

- 132102-067 rosso/red 527
- 132103-067 nero/black
- 132104-067 grigio/gray 7035
- 132105-067 bianco/white 218
- 132114-067 viola/violet 145
- 132115-067 blu/blue 5023
- 132116-067 verde/pastel green 6019



**07** coppia inserti schienale  
pair plastic back inserts

- 132102-066 rosso/red 527
- 132103-066 nero/black
- 132104-066 grigio/gray 7035
- 132105-066 bianco/white 218
- 132114-066 viola/violet 145
- 132115-066 blu/blue 5023
- 132116-066 verde/pastel green 6019



**08** coppia braccioli destro-sinistro in plastica  
pair plastic armrests right-left

- 131702-055 rosso/red 527
- 131703-055 nero/black
- 131704-055 grigio/gray 7035
- 131705-055 bianco/white 218
- 131714-055 viola/violet 145
- 131715-055 blu/blue 5023
- 131716-055 verde/pastel green 6019



**09** coppia braccioli destro-sinistro in plastica per tavoletta  
pair plastic armrests right-left for tablet

- 131702-056 rosso/red 527
- 131703-056 nero/black
- 131704-056 grigio/gray 7035
- 131705-056 bianco/white 218
- 131714-056 viola/violet 145
- 131715-056 blu/blue 5023
- 131716-056 verde/pastel green 6019



**10** sedile in plastica  
plastic seat

- 132202-070 rosso/red 527
- 132203-070 nero/black
- 132204-070 grigio/gray 7035
- 132205-070 bianco/white 218
- 132214-070 viola/violet 145
- 132215-070 blu/blue 5023
- 132216-070 verde/pastel green 6019



**11** sottosedile in plastica  
outer plastic seat

- 132202-071 rosso/red 527
- 132203-071 nero/black
- 132204-071 grigio/gray 7035
- 132205-071 bianco/white 218
- 132214-071 viola/violet 145
- 132215-071 blu/blue 5023
- 132216-071 verde/pastel green 6019



**06** cornice schienale in plastica per rete  
frame back in plastic for mesh

- 132103-063 nero/black



**04** telaio schienale esterno portante in plastica  
outer plastic back in plastic

- 132103-065 nero/black



**05** pannello schienale in plastica da tappezzare  
frame back in plastic for upholstery

- 132103-064 nero/black

