

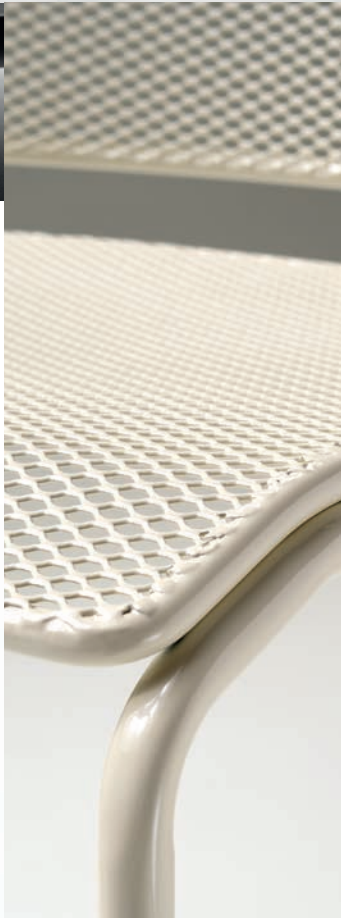

BEYOND | **Design**





**tapas**



# tapas



stool

high table

low table

coffee table

metal slide  
metal 4-legs  
metal stool

# tapas showing



tools



brochure

## features



designed by:  
edi & paolo ciani design



outdoor  
ready



### Une nouvelle ligne pour le secteur Ho.re.ca.

Cette collection innovante et complète se compose de deux familles. La première, permet une utilisation **indoor & outdoor**, elle est totalement démontable, facile à assembler et de grande solidité, avec un design fonctionnel et polyvalent grâce aux nombreuses finitions proposées. La deuxième a été **exclusivement conçue pour l'outdoor**, avec des châssis spécifiques et des finitions de matériaux parfaites pour ce type d'utilisation.

#### Plus:

- de nombreuses finitions proposées;
- une polyvalence d'utilisation grâce aux finitions spécifiques proposées pour l'outdoor;
- les kits de la famille indoor & outdoor prévoient un emballage démonté afin de réduire les coûts de manutention;
- une simplicité d'assemblage.

Tapas est idéale pour un **environnement professionnel**.

### La nueva línea para el canal Ho.re.ca.

Una colección innovadora y completa, articulada en dos familias. La primera de ellas, destinada al uso en el **interior y el exterior**, se desmonta completamente, es práctica de ensamblar y sumamente sólida, con un diseño funcional y versátil por sus numerosas variantes de acabado. La segunda se ha pensado **específicamente para el exterior**, con bastidores dedicados y acabados ideales de los materiales para este tipo de utilización.

#### Pluses:

- numerosas variantes de acabado;
- utilización versátil con los acabados específicos para el exterior;
- los kits de la familia para el interior y el exterior contemplan un embalaje desmontado para reducir los costes de manipulación;
- ensamblaje sencillo.

Tapas es ideal para el **ambiente Contract**.

# tapas

## stool

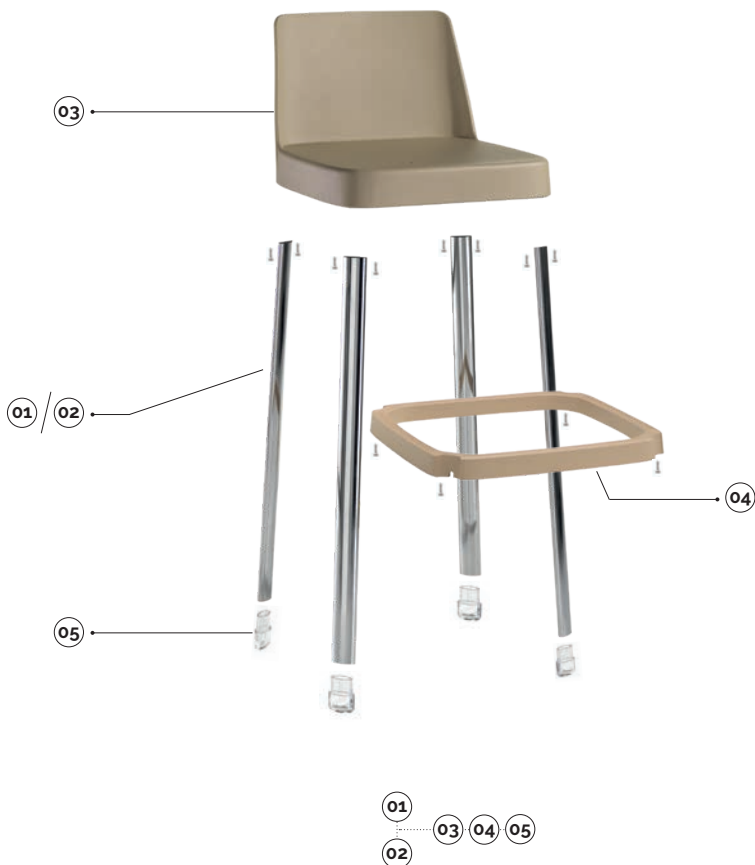

plastic colours

- ivoire/marfil ral1013
- noisette/avellana 2312u
- gris/gris ig2621
- noir/negro ral9005

**Corten** • \*Une caractéristique spécifique du Corten est la variabilité dans la tonalité de la finition.  
 \* Una característica particular del Corten es las variabilidad en la tonalidad del acabado.

main component sizes

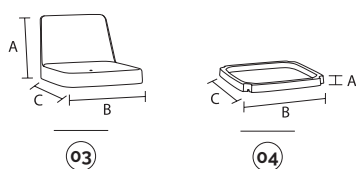
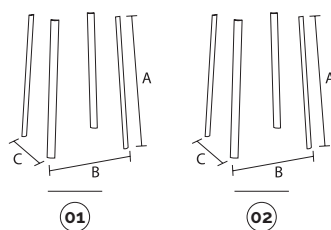

### 01 tapas-tabouret h650 kit n°4 pieds avec vis tapas-taburete h650 kit n°4 patas con tornillos

code	finishing	q.kit	q.pack	a	b	c	kg.x1	vol.x1
110603-637	● noir/negro	x1	5	650	410	410	3.54	mc. 0.0035
110604-637	● gris/gris ig2621	x1	5	650	410	410	3.54	mc. 0.0035
110605-637	● ivoire/marfil ral 1013	x1	5	650	410	410	3.54	mc. 0.0035
110607-637	● corten*	x1	5	650	410	410	3.54	mc. 0.0035
110610-637	● chromé/cromado	x1	5	650	410	410	3.54	mc. 0.0035
110603-638	● noir/negro *pour extérieur/para exterior	x1	5	650	410	410	3.54	mc. 0.0035
110604-638	● gris/gris ig2621 *pour extérieur/para exterior	x1	5	650	410	410	3.54	mc. 0.0035
110605-638	● ivoire/marfil ral 1013 *pour extérieur/para exterior	x1	5	650	410	410	3.54	mc. 0.0035
110607-638	● corten* *pour extérieur/para exterior	x1	5	650	410	410	3.54	mc. 0.0035

### 02 tapas-tabouret h750 kit n°4 pieds avec vis tapas-taburete h750 kit n°4 patas con tornillos

code	finishing	q.kit	q.pack	a	b	c	kg.x1	vol.x1
110603-635	● noir/negro	x1	5	750	422	422	3.54	mc. 0.0035
110604-635	● gris/gris ig2621	x1	5	750	422	422	3.54	mc. 0.0035
110605-635	● ivoire/marfil ral 1013	x1	5	750	422	422	3.54	mc. 0.0035
110607-635	● corten*	x1	5	750	422	422	3.54	mc. 0.0035
110610-635	● chromé/cromado	x1	5	750	422	422	3.54	mc. 0.0035
110603-636	● noir/negro *pour extérieur/para exterior	x1	5	750	422	422	3.54	mc. 0.0035
110604-636	● gris/gris ig2621 *pour extérieur/para exterior	x1	5	750	422	422	3.54	mc. 0.0035
110605-636	● ivoire/marfil ral 1013 *pour extérieur/para exterior	x1	5	750	422	422	3.54	mc. 0.0035
110607-636	● corten* *pour extérieur/para exterior	x1	5	750	422	422	3.54	mc. 0.0035

### 03 tapas-coque en plastique pour tabouret tapas-carcasa de plástico para taburete

code	finishing	q.kit	q.pack	a	b	c	kg.x1	vol.x1
130603-003	● noir/negro	x1	5	276	382	458	2.06	mc. 0.02045
130604-001	● gris/gris 650	x1	5	276	382	458	2.06	mc. 0.02045
130605-003	● ivoire/marfil ral 1013	x1	5	276	382	458	2.06	mc. 0.02045
130607-003	● noisette/avellana 2312u	x1	5	276	382	458	2.06	mc. 0.02045

### 04 tapas-repose-pieds pour tabouret tapas-reposapiés para taburete

code	finishing	q.kit	a	b	c	kg.x1		
130603-000	● noir/negro	x1	5	34	417	417	0.874	mc. 0.01092
130604-000	● gris/gris 650	x1	5	34	417	417	0.874	mc. 0.01092
130605-002	● ivoire/marfil ral 1013	x1	5	34	417	417	0.874	mc. 0.01092
130607-000	● noisette/avellana 2312u	x1	5	34	417	417	0.874	mc. 0.01092

### 05 tapas-pied elliptique 40x20 h30 tapas-tapón elíptico 40x20 h30

code	finishing	q.kit	kg.x1	
134303-045	● noir/negro	x4	0.0174	mc. 0.00003
134306-005	○ transparent/transparente	x4	0.0174	mc. 0.00003



# tapas

## high table

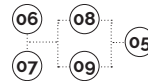
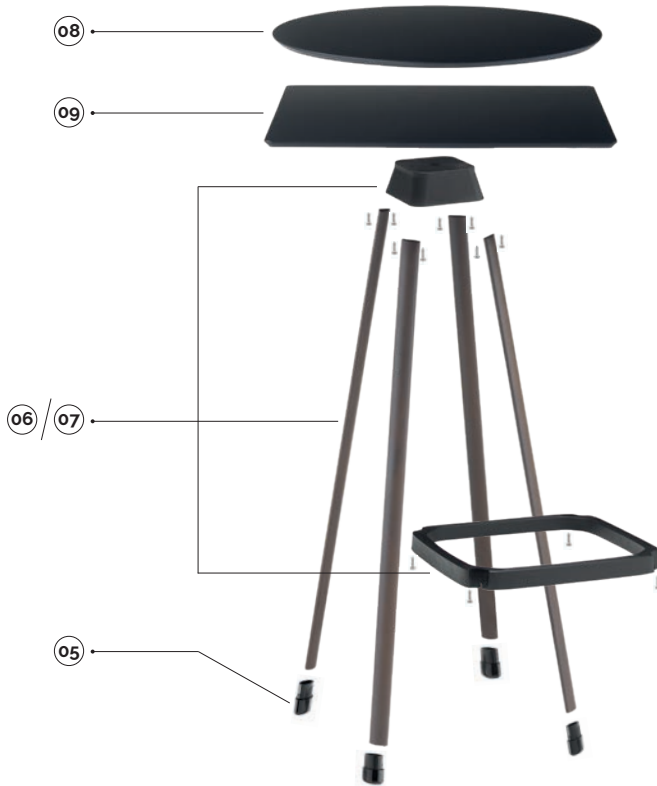

On recommande les suivantes  
mesures des plateaux:  
Se recomiendan las siguientes  
medidas de tableros:

- high table: 590 / 690 mm

plastic colours

- ivoire/marfil ral1013
- noir/negro ral9005

**Corten**  
• \*Une caractéristique spécifique du Corten est la variabilité dans la tonalité de la finition.  
\* Una característica particular del Corten es las variabilidad en la tonalidad del acabado.

main component sizes

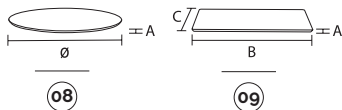
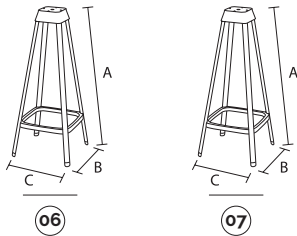

### 06 tapas-kit piètements table haute avec vis + support + repose-pieds ivoire r1013

tapas-kit patas mesa alta con tornillos + soporte + reposapiés marfil r1013

code	finishing	q.kit	q.pack	a	b	c	kg.x1	vol.x1
110303-244	● noir/negro	x1	2	1085	453	453	8,0	mc. 0.02365
110304-244	● gris/gris ig2621	x1	2	1085	453	453	8,0	mc. 0.02365
110305-244	● ivoire/marfil ral 1013	x1	2	1085	453	453	8,0	mc. 0.02365
110307-244	● corten*	x1	2	1085	453	453	8,0	mc. 0.02365
110310-244	● chromé/cromado	x1	2	1085	453	453	8,0	mc. 0.02365
110303-246	● noir/negro "pour extérieur/para exterior"	x1	2	1085	453	453	8,0	mc. 0.02365
110304-246	● gris/gris ig2621 "pour extérieur/para exterior"	x1	2	1085	453	453	8,0	mc. 0.02365
110305-246	● ivoire/marfil ral 1013 "pour extérieur/para exterior"	x1	2	1085	453	453	8,0	mc. 0.02365
110307-246	● corten* "pour extérieur/para exterior"	x1	2	1085	453	453	8,0	mc. 0.02365

### 07 tapas-kit piètements table haute avec vis + support + repose-pieds noir

tapas-kit patas mesa alta con tornillos + soporte + reposapiés negro

code	finishing	q.kit	q.pack	a	b	c	kg.x1	vol.x1
110303-245	● noir/negro	x1	2	1085	453	453	8,0	mc. 0.02365
110304-245	● gris/gris ig2621	x1	2	1085	453	453	8,0	mc. 0.02365
110305-245	● ivoire/marfil ral 1013	x1	2	1085	453	453	8,0	mc. 0.02365
110307-245	● corten*	x1	2	1085	453	453	8,0	mc. 0.02365
110310-245	● chromé/cromado	x1	2	1085	453	453	8,0	mc. 0.02365
110303-247	● noir/negro "pour extérieur/para exterior"	x1	2	1085	453	453	8,0	mc. 0.02365
110304-247	● gris/gris ig2621 "pour extérieur/para exterior"	x1	2	1085	453	453	8,0	mc. 0.02365
110305-247	● ivoire/marfil ral 1013 "pour extérieur/para exterior"	x1	2	1085	453	453	8,0	mc. 0.02365
110307-247	● corten* "pour extérieur/para exterior"	x1	2	1085	453	453	8,0	mc. 0.02365

### 08 tapas-plateau rond + vis

tapas-sobre redondo + tornillos

code	finishing	q.kit	q.pack	a	ø	kg.x1	vol.x1
120303-004	● noir/negro	x1	5	12	590	4,8	mc. 0.0072
120303-005	● noir/negro	x1	5	12	690	6,6	mc. 0.0098
120303-006	● noir/negro	x1	5	12	790	8,4	mc. 0.0128
120305-004	● ivoire/marfil ral 1013	x1	5	12	590	4,8	mc. 0.0072
120305-005	● ivoire/marfil ral 1013	x1	5	12	690	6,6	mc. 0.0098
120305-006	● ivoire/marfil ral 1013	x1	5	12	790	8,4	mc. 0.0128

### 09 tapas-plateau carré + vis

tapas-sobre cuadrado + tornillos

code	finishing	q.kit	q.pack	a	b	c	kg.x1	vol.x1
120303-008	● noir/negro	x1	5	12	590	590	6,0	mc. 0.0072
120303-009	● noir/negro	x1	5	12	690	690	8,2	mc. 0.0098
120303-010	● noir/negro	x1	5	12	790	790	10,7	mc. 0.0128
120305-008	● ivoire/marfil ral 1013	x1	5	12	590	590	6,0	mc. 0.0072
120305-009	● ivoire/marfil ral 1013	x1	5	12	690	690	8,2	mc. 0.0098
120305-010	● ivoire/marfil ral 1013	x1	5	12	790	790	10,7	mc. 0.0128

### 05 tapas-pied elliptique 40x20 h30

tapas-tapón elíptico 40x20 h30

code	finishing	q.kit	kg.x1
134303-045	● noir/negro	x4	0,0174 mc. 0.00003
134306-005	○ transparent/transparente	x4	0,0174 mc. 0.00003



# tapas

## low table

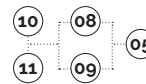
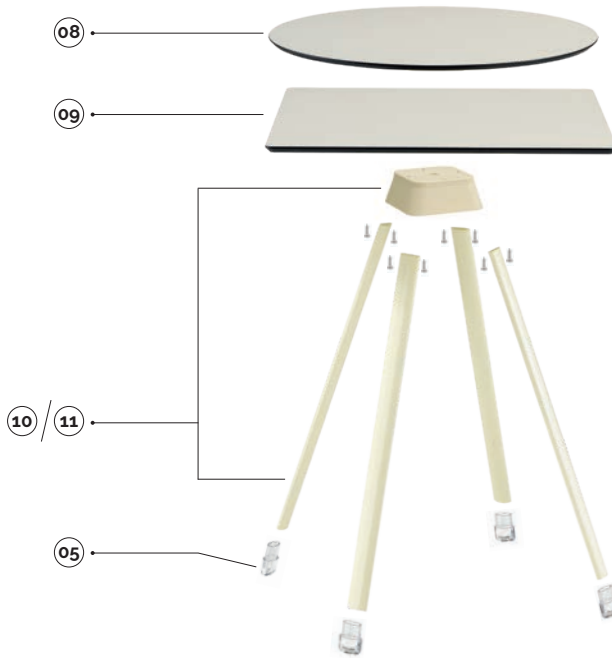

On recommande les suivantes  
mesures des plateaux:  
Se recomiendan las siguientes  
medidas de tableros:

- low table: 690/ 790 mm

plastic colours

- ivoire/marfil ral1013
- noir/negro ral9005

Corten ● **"Une caractéristique spécifique du Corten est la variabilité dans la tonalité de la finition.**  
\* Una característica particular del Corten es las variabilidad en la tonalidad del acabado.

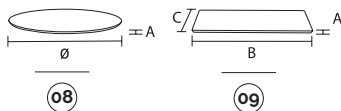
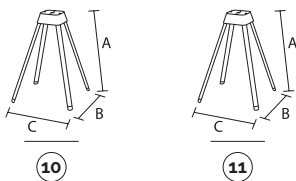

main component sizes

### 10 tapas-kit piètements table moyenne avec vis + support ivoire r1013

tapas-kit patas mesa baja con tornillos + soporte marfil r1013

code	finishing	q.kit	q.pack	a	b	c	kg.x1	vol.x1
110303-240	● noir/negro	x1	2	730	530	530	5.11	mc. 0.01155
110304-240	● gris/gris ig2621	x1	2	730	530	530	5.11	mc. 0.01155
110305-240	● ivoire/marfil ral 1013	x1	2	730	530	530	5.11	mc. 0.01155
110307-240	● corten*	x1	2	730	530	530	5.11	mc. 0.01155
110310-240	● chromé/cromado	x1	2	730	530	530	5.11	mc. 0.01155
110303-242	● noir/negro "pour extérieur/para exterior"	x1	2	730	530	530	5.11	mc. 0.01155
110304-242	● gris/gris ig2621 "pour extérieur/para exterior"	x1	2	730	530	530	5.11	mc. 0.01155
110305-242	● ivoire/marfil ral 1013 "pour extérieur/para exterior"	x1	2	730	530	530	5.11	mc. 0.01155
110307-242	● corten* "pour extérieur/para exterior"	x1	2	730	530	530	5.11	mc. 0.01155

### 11 tapas-kit piètements table moyenne avec vis + support noir

tapas-kit patas mesa baja con tornillos + soporte negro

code	finishing	q.kit	q.pack	a	b	c	kg.x1	vol.x1
110303-241	● noir/negro	x1	2	730	530	530	5.11	mc. 0.01155
110304-241	● gris/gris ig2621	x1	2	730	530	530	5.11	mc. 0.01155
110305-241	● ivoire/marfil ral 1013	x1	2	730	530	530	5.11	mc. 0.01155
110307-241	● corten*	x1	2	730	530	530	5.11	mc. 0.01155
110310-241	● chromé/cromado	x1	2	730	530	530	5.11	mc. 0.01155
110303-243	● noir/negro "pour extérieur/para exterior"	x1	2	730	530	530	5.11	mc. 0.01155
110304-243	● gris/gris ig2621 "pour extérieur/para exterior"	x1	2	730	530	530	5.11	mc. 0.01155
110305-243	● ivoire/marfil ral 1013 "pour extérieur/para exterior"	x1	2	730	530	530	5.11	mc. 0.01155
110307-243	● corten* "pour extérieur/para exterior"	x1	2	730	530	530	5.11	mc. 0.01155

### 08 tapas-plateau rond + vis

tapas-sobre redondo + tornillos

code	finishing	q.kit	q.pack	a	ø	kg.x1	vol.x1
120303-004	● noir/negro	x1	5	12	590	4.8	mc. 0.0072
120303-005	● noir/negro	x1	5	12	690	6.6	mc. 0.0098
120303-006	● noir/negro	x1	5	12	790	8.4	mc. 0.0128
120305-004	● ivoire/marfil ral 1013	x1	5	12	590	4.8	mc. 0.0072
120305-005	● ivoire/marfil ral 1013	x1	5	12	690	6.6	mc. 0.0098
120305-006	● ivoire/marfil ral 1013	x1	5	12	790	8.4	mc. 0.0128

### 09 tapas-plateau carré + vis

tapas-sobre cuadrado + tornillos

code	finishing	q.kit	q.pack	a	b	c	kg.x1	vol.x1
120303-008	● noir/negro	x1	5	12	590	590	6.0	mc. 0.0072
120303-009	● noir/negro	x1	5	12	690	690	8.2	mc. 0.0098
120303-010	● noir/negro	x1	5	12	790	790	10.7	mc. 0.0128
120305-008	● ivoire/marfil ral 1013	x1	5	12	590	590	6.0	mc. 0.0072
120305-009	● ivoire/marfil ral 1013	x1	5	12	690	690	8.2	mc. 0.0098
120305-010	● ivoire/marfil ral 1013	x1	5	12	790	790	10.7	mc. 0.0128

### 05 tapas-pied elliptique 40x20 h30

tapas-tapón elíptico 40x20 h30

code	finishing	q.kit	kg.x1
134303-045	● noir/negro	x4	0.0174 mc. 0.00003
134306-005	○ transparent/transparente	x4	0.0174 mc. 0.00003



# tapas

## coffee table

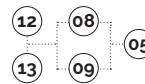
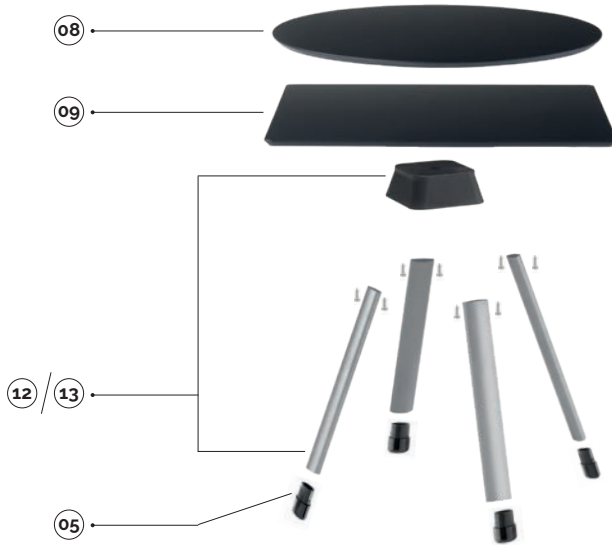

On recommande les suivantes  
mesures des plateaux:  
Se recomiendan las siguientes  
medidas de tableros:

- coffee table: 590 mm

plastic colours

- ivoire/marfil ral1013
- noir/negro ral9005

**Corten** • \*Une caractéristique spécifique du Corten est la variabilité dans la tonalité de la finition.  
\* Una característica particular del Corten es las variabilidad en la tonalidad del acabado.

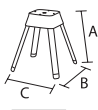

12

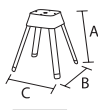

13

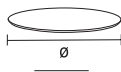

08

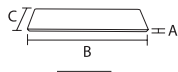

09

main component sizes



### 12 tapas-kit piètements table basse avec vis + support ivoire r1013 tapas-kit patas mesita de café con tornillos + soporte marfil r1013

code	finishing	q.kit	q.pack	a	b	c	kg.x1	vol.x1
110303-248	• noir/negro	x1	2	390	353	353	2,92	mc. 0.006405
110304-248	• gris/gris ig2621	x1	2	390	353	353	2,92	mc. 0.006405
110305-248	• ivoire/marfil ral 1013	x1	2	390	353	353	2,92	mc. 0.006405
110307-248	• corten*	x1	2	390	353	353	2,92	mc. 0.006405
110310-248	• chromé/cromado	x1	2	390	353	353	2,92	mc. 0.006405
110303-250	• noir/negro *pour extérieur/para exterior	x1	2	390	353	353	2,92	mc. 0.006405
110304-250	• gris/gris ig2621 *pour extérieur/para exterior	x1	2	390	353	353	2,92	mc. 0.006405
110305-250	• ivoire/marfil ral 1013 *pour extérieur/para exterior	x1	2	390	353	353	2,92	mc. 0.006405
110307-250	• corten* *pour extérieur/para exterior	x1	2	390	353	353	2,92	mc. 0.006405

### 13 tapas-kit piètements table basse avec vis + support noir tapas-kit patas mesita de café con tornillos + soporte negro

code	finishing	q.kit	q.pack	a	b	c	kg.x1	vol.x1
110303-249	• noir/negro	x1	2	390	353	353	2,92	mc. 0.006405
110304-249	• gris/gris ig2621	x1	2	390	353	353	2,92	mc. 0.006405
110305-249	• ivoire/marfil ral 1013	x1	2	390	353	353	2,92	mc. 0.006405
110307-249	• corten*	x1	2	390	353	353	2,92	mc. 0.006405
110310-249	• chromé/cromado	x1	2	390	353	353	2,92	mc. 0.006405
110303-251	• noir/negro *pour extérieur/para exterior	x1	2	390	353	353	2,92	mc. 0.006405
110304-251	• gris/gris ig2621 *pour extérieur/para exterior	x1	2	390	353	353	2,92	mc. 0.006405
110305-251	• ivoire/marfil ral1013 *pour extérieur/para exterior	x1	2	390	353	353	2,92	mc. 0.006405
110307-251	• corten* *pour extérieur/para exterior	x1	2	390	353	353	2,92	mc. 0.006405

### 08 tapas-plateau rond + vis tapas-sobre redondo + tornillos

code	finishing	q.kit	q.pack	a	ø	kg.x1	vol.x1
120303-004	• noir/negro	x1	5	12	590	4,8	mc. 0.0072
120303-005	• noir/negro	x1	5	12	690	6,6	mc. 0.0098
120303-006	• noir/negro	x1	5	12	790	8,4	mc. 0.0128
120305-004	• ivoire/marfil ral 1013	x1	5	12	590	4,8	mc. 0.0072
120305-005	• ivoire/marfil ral 1013	x1	5	12	690	6,6	mc. 0.0098
120305-006	• ivoire/marfil ral 1013	x1	5	12	790	8,4	mc. 0.0128

### 09 tapas-plateau carré + vis tapas-sobre cuadrado + tornillos

code	finishing	q.kit	q.pack	a	b	c	kg.x1	vol.x1
120303-008	• noir/negro	x1	5	12	590	590	6,0	mc. 0.0072
120303-009	• noir/negro	x1	5	12	690	690	8,2	mc. 0.0098
120303-010	• noir/negro	x1	5	12	790	790	10,7	mc. 0.0128
120305-008	• ivoire/marfil ral 1013	x1	5	12	590	590	6,0	mc. 0.0072
120305-009	• ivoire/marfil ral 1013	x1	5	12	690	690	8,2	mc. 0.0098
120305-010	• ivoire/marfil ral 1013	x1	5	12	790	790	10,7	mc. 0.0128

### 05 tapas-pied elliptique 40x20 h30 tapas-tapón elíptico 40x20 h30

code	finishing	q.kit	kg.x1
134303-045	• noir/negro	x4	0,0174 mc. 0.00003
134306-005	• transparente/transparente	x4	0,0174 mc. 0.00003



# tapas

4-legs/metal shell



14 15 16

Corten • \*Une caractéristique spécifique du Corten est la variabilité dans la tonalité de la finition.  
 \* Una característica particular del Corten es las variabilidad en la tonalidad del acabado.

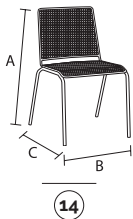

main component sizes

**14** châssis 4 pieds avec coque en maillage  
 estructura 4 patas con carcasa de malla

code	finishing		q.kit	q.pack	a	b	c	kg.x1	vol.x1
110105-367	● ivoire/marfil	rat.1013 *pour extérieur/para exterior	x1	1	805	535	580	5,6	mc. 0.024
110107-367	● corten*	*pour extérieur/para exterior	x1	1	805	535	580	5,6	mc. 0.024

**15** pack embouts sphérique d.18 noirs  
 paquete de tapon esférico d.18 negros

code	finishing	q.kit	q.pack
137003-072	● noir/negro	x4	200

**16** pare-chocs tête plate 12x3,8x6x9 neutre  
 protectores cabeza llana 12x3,8x6x9 neutra

code	finishing	q.kit
134006-100	○ neutre/neutro	x4

# tapas

stool/metal shell



17 15 16

Corten • \*Une caractéristique spécifique du Corten est la variabilité dans la tonalité de la finition.  
\* Una característica particular del Corten es la variabilidad en la tonalidad del acabado.

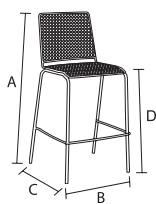

17

main component sizes

**17** tabouret h750 avec coque en maillage  
taburete h750 con carcasa de malla

code	finishing		q.kit	q.pack	a	b	c	d	kg.x1	vol.x1
110105-374	● ivoire/marfil	ral.1013 *pour extérieur/para exterior	x1	1	1100	540	540	750	7,8	mc. 0,048
110107-374	● corten*	*pour extérieur/para exterior	x1	1	1100	540	540	750	7,8	mc. 0,048

**15** pack embouts sphérique d.18 noirs  
paquete de tapón esférico d.18 negros

code	finishing	q.kit	q.pack
137003-072	● noir/negro	x4	200

**16** pare-chocs tête plate 12x3,8x6x9 neutre  
protectores cabeza llana 12x3,8x6x9 neutra

code	finishing	q.kit
134006-100	○ neutre/neutro	x4

# tapas

slide/metal shell

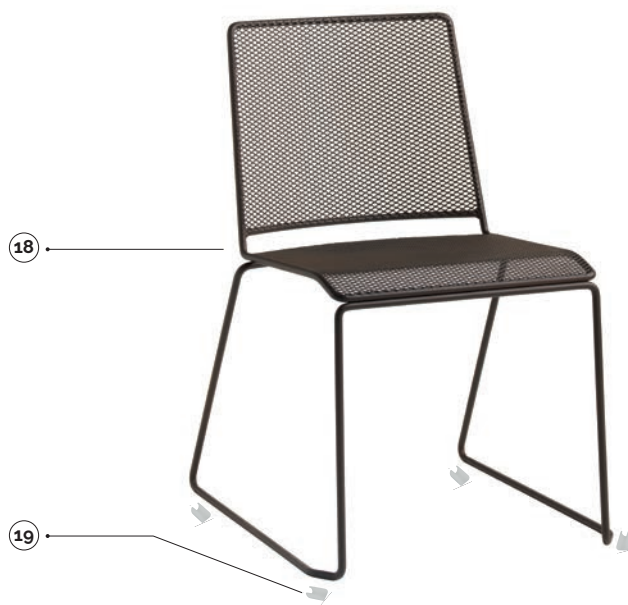

18 19

Corten ● \*Une caractéristique spécifique du Corten est la variabilité dans la tonalité de la finition.  
 \* Una característica particular del Corten es las variabilidad en la tonalidad del acabado.

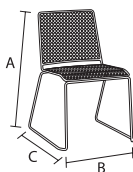

18

main component sizes

**18** châssis coulissant tige d. 12 avec coque en mailage  
 estructura patin de varilla d. 12 con carcasa de malla

code	finishing		q.kit	q.pack	a	b	c	kg.x1	vol.x1
110505-504	● ivoire/marfil	ral.1013 *pour extérieur/para exterior	x1	1	805	520	595	7.7	mc. 0.036
110507-504	● corten*	*pour extérieur/para exterior	x1	1	805	520	595	7.7	mc. 0.036

**19** pack de bases a pince anti-rotation pour tige couleur neutre  
 paquete de bases con pinza antirotacion para varilla de color neutro

code	finishing	q.kit	q.pack
137006-070	○ neutre/neutro	x4	200

