

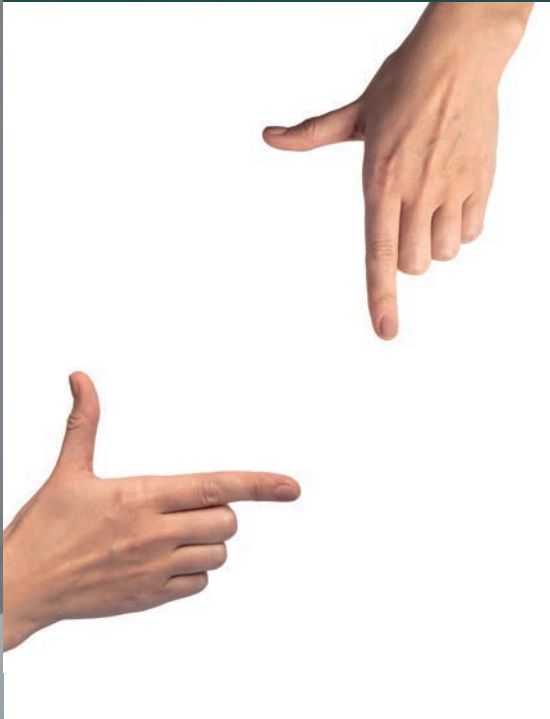

BEYOND | **Logistic**





**pull**



# pull



---

slide

4 legs

swivel

bench

## pull showing

---

### features



trolley  
available



Cette assise est dotée d'un **dessin moderne et séduisant** et d'une monocoque en plastique proposée dans plusieurs couleurs.

Elle est parfaite pour différents **environnements s'adressant au Public**, où il est indispensable de pouvoir **l'empiler** et où elle doit être **légère et simple à utiliser** : elle est parfaite pour le **secteur professionnel**, les **salles d'attentes**, mais aussi pour le **secteur formation**.

En plus de la version 4 pieds et traîneau, cette assise est prévue pour la version tournante et pour les bancs.

*Un asiento de **diseño moderno y atractivo**, con monocarcasa de plástico en varios colores.*

*Es ideal para los varios **ambientes de la colectividad**, donde se demanda **apilabilidad, ligereza y sencillez de utilización**: **contract, zonas de espera y sector de formación**.*

*Junto a las versiones de 4 patas y de patín, encontramos las versiones giratorias y la bancada.*

# pull

## slide

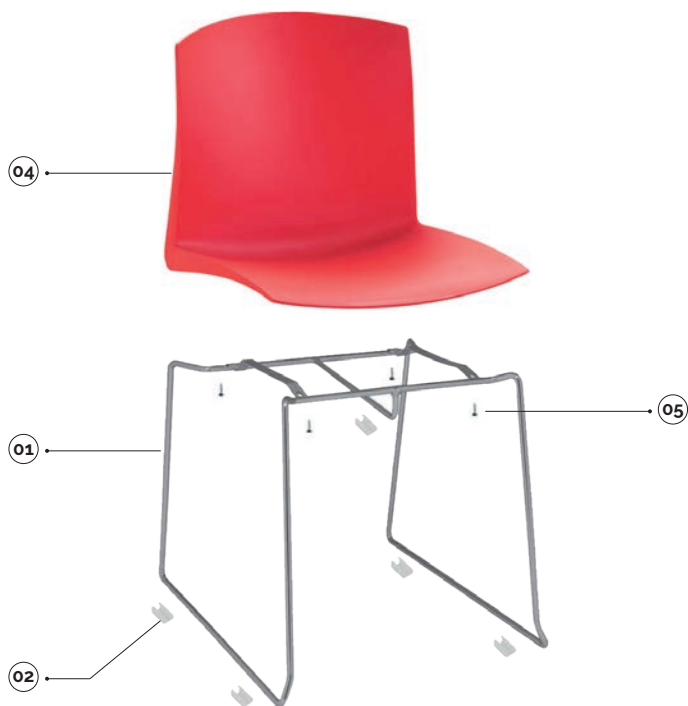

plastic colours

- gris/gris ral 7035
- noir/negro
- orange/naranja ral 2003
- blanc/blanco 218
- rouge/rojo 527

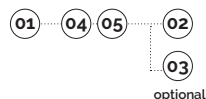

main component sizes

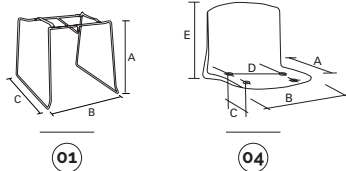

optionals

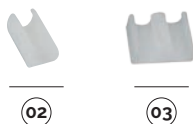

### 01 speedy-tabouret en tige pour coque modèle pull speedy-estructura de varilla para carcasa modelo pull

code	finishing	q.kit	q.pack	a	b	c	kg.x1	vol.x1
113410-025	● chromé/cromado	x1	120	450	580	570	3,05	mc. 0,04

### 02 pack de bases à pince anti-rotation pour tige couleur neutre paquete de bases con pinza antirotación para varilla de color neutro

code	finishing	q.kit	q.pack
137006-070	○ neutre/neutro	x4	200

### 03 base plate à pince double en pe pour élément de jonction chaises base plana con pinza doble de pe para varilla para unión sillas

code	finishing	q.kit
134006-021	○ neutre/neutro	x4

### 04 pull-coque entière modèle pull pull-carcasa completa modelo pull

code	finishing	q.kit	q.pack	a	b	c	d	e	kg.x1	vol.x1
133902-026	● rouge/rojo 527	x1	10	520	450	255	315	393	1,60	mc. 0,021

### 05 vis tc+combi 6x16 tête cylindrique croix zinguée (vis fixation coque) tornillo tc+combi 6x16 cabeza cilíndrica en cruz galvanizada (tornillo fijación carcasa)

code	finishing	q.kit
117811-181	○ zinguée/galvanizada	x4

### speedy-chariot porte-chaises avec accessoires speedy-carro para sillas con accesorios

code	finishing
110803-358	● noir/negro



for all colour codes, see page 101

# pull

## 4-legs



plastic colours

- gris/gris ral 7035
- noir/negro
- orange/naranja ral 2003
- blanc/blanco 218
- rouge/rojo 527

main component sizes

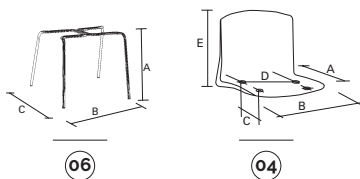

optional

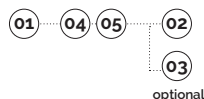

### 06 pull-tabouret 4 pieds tube d.18 pull-taburete 4 patas tubular d.18

code	finishing	q.kit	q.pack	a	b	c	kg.x1	vol.x1
110603-075	● noir/negro	x1	200	450	470	490	2,00	mc. 0,02
110604-095	● gris/gris	x1	200	450	470	490	2,00	mc. 0,02
110610-045	● chromé/cromado	x1	200	450	470	490	2,00	mc. 0,02

### 07 pack embouts ronds ø18 noirs paquete de tacos redondos d.18 negros

code	finishing	q.kit	q.pack
137003-072	● noir/negro	x4	200

### 08 pack vis hilo 5,5x30 tête évasée croix zinguée (vis pour fixation coque) paquete de tornillos hi-lo 5,5x30 cabeza avellanada en cruz galvanizados (tornillo para fijación carcasa)

code	finishing	q.kit	q.pack
117011-071	○ zinguée/galvanizada	x4	200

### 04 pull-coque entière modèle pull pull-carcasa completa modelo pull

code	finishing	q.kit	q.pack	a	b	c	d	e	kg.x1	vol.x1
133903-025	● noir/negro	x1	10	520	450	255	315	393	1,60	mc. 0,021

### 09 support pour empiler les coques neutres soporte para apilabilidad carcasa neutro

code	finishing	q.kit	kg.x1
134006-030	○ neutre/neutro	x1	0,025

### 10 vis hilo tb 5x14 noire tornillo hi-lo tb 5x14 negro

code	finishing	q.kit
117803-155	● noir/negro	x1

### pull-chariot porte-chaises avec accessoires pull-carro para sillas con accesorios

code	finishing
110803-347	● noir/negro



for all colour codes, see page 101

# pull swivel



plastic colours

- gris/gris ral 7035
- noir/negro
- orange/naranja ral 2003
- blanc/blanco 218
- rouge/rojo 527

main component sizes

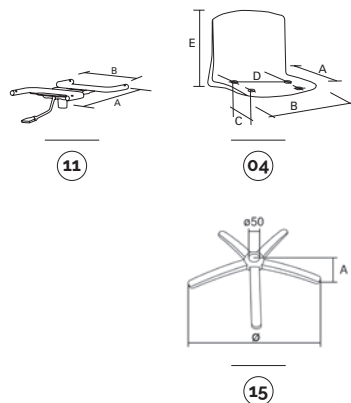

options

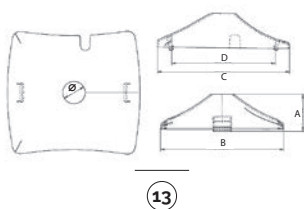

11 04 08 12 13 15  
optional

**11** support pivotant au gaz pour coque pull  
soporte versión giratoria con mecanismo de gas para carcasa pull

code	finishing	q.kit	q.pack	a	b	kg.x1	vol.x1
110903-025	● noir/negro	x1	10	315	255	1.40	mc. 0.004

**12** pack embouts couvre-tête ø18  
paquete de tapones d.18

code	finishing	q.kit	q.pack
137003-070	● noir/negro	x4	200

**04** pull-coque entière modèle pull  
pull-carcasa completa modelo pull

code	finishing	q.kit	q.pack	a	b	c	d	e	kg.x1	vol.x1
133907-025	● orange/naranja ral 2003	x1	10	520	450	255	315	393	1.60	mc. 0.021

**08** pack vis hilo 5,5x30 tête évasée croix zinguée (vis pour fixation coque)  
paquete de tornillos hi-lo 5,5x30 cabeza avellanada en cruz galvanizados (tornillo para fijación carcasa)

code	finishing	q.kit	q.pack
117011-071	○ zinguée/galvanizada	x4	200

**13** cpg-couverture en plastique pour châssis pivotant  
cpg-cubierta de plástico para estructura versión giratoria

code	finishing	q.kit	q.pack	a	b	c	d	ø	kg.x1	vol.x1
130903-000	● noir/negro	x1	50	60	200	210	167	36	0.1	mc. 0.0015

**15** b40-base en métal avec cache-soudure  
b40-base de metal con embellecedor soldadura

code	finishing	q.kit	q.pack	a	ø	kg.x1	vol.x1
110210-027	● chromé/cromado	x1	5	60	640	2.85	mc. 0.014

CPG  
plastic cover for swivel frame



➔ for all colour codes, see page 101

# pull

## bench



plastic colours

- gris/gris ral 7035
- noir/negro
- orange/naranja ral 2003
- blanc/blanco 218
- rouge/rojo 527

14 04 08 12

14 support pour raccordement coque pull sur banquette  
soporte para enganche carcasa pull en bancada

code	finishing	q.kit	q.pack	a	b	kg.x1	vol.x1
110703-085	● noir/negro	x1	10	315	255	1.40	mc. 0.004

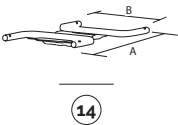

for the components below, see page 100

for all colour codes, see below

12 04 08

for the bench components, see page 201

main component sizes

optionals

OPTIONAL  
bench  
connector

E-USB NEW  
bench plug



JIM NEW  
bench leg

APOLL  
bench arm



plastic

90GM  
bench leg

90GF  
bench leg

100GM  
bench leg

200GM  
bench leg

PIONEER  
bench arm



metal

CUT  
bench leg

SLIM  
bench leg

CUT  
bench arm

SLIM  
bench arm



aluminium

# pull

## optional colour codes



### shell colour codes

04 coque en plastique  
carcasa de plástico

- 133904-026 gris/gris ral 7035
- 133903-025 noir/negro
- 133907-025 orange/naranja ral 2003
- 133905-026 blanc/blanco 218
- 133902-026 rouge/rojo 527

