

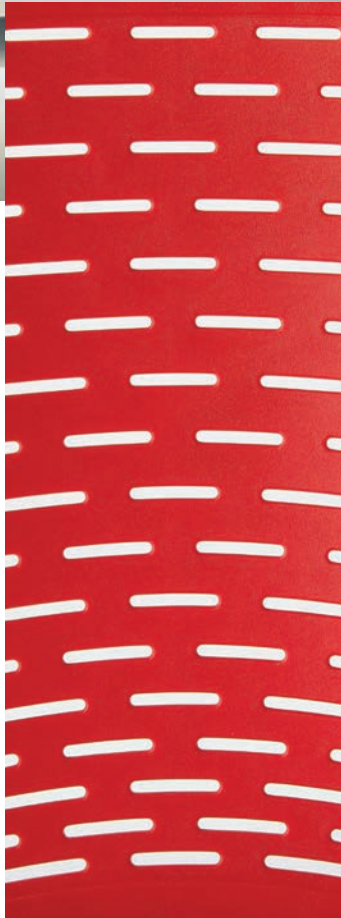

BEYOND | **Solutions**





X3



X3



slide
slide w/armrests
slide w/writing tablet

4 legs
4 legs w/armrest
4 legs w/writing tablet

swivel
swivel w/armrest

bench
bench w/armrest

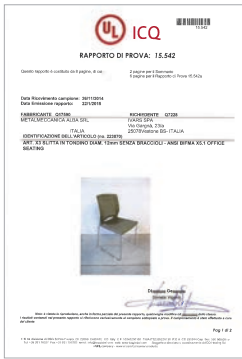

BIFMA TEST



BIFMA TEST

x3 showing



tools



certification



Une **assise en plastique** proposée dans 4 couleurs, que se caractérise par son **design distinctif**.

Elle se présente dans différentes versions: avec un dossier en plastique plein ou ajouré, un dossier en résille, des panneaux de chaises et des dossiers en plastique à tapisser.

Il est par ailleurs possible de choisir parmi un large choix d'assortiment de châssis, en offrant ainsi plusieurs solutions adaptées au **bureau et au public**, car ce modèle est facilement empilable. **X3** est une assise **certifiée CATAS et BIFMA**.

*Un **asiento de plástico**, disponible en 4 colores, y caracterizado por un diseño distintivo.*

*Existe en varias versiones: respaldo de plástico macizo o perforado, respaldo de malla, paneles tapizables para asiento y respaldo de plástico. Asimismo, se puede elegir entre un surtido amplio de estructuras, que ofrece soluciones diferentes para los ambientes de la **oficina** y de la **colectividad**, también por su cómoda apilabilidad. **X3** es un asiento **certificado CATAS y BIFMA**.*

X3 slide

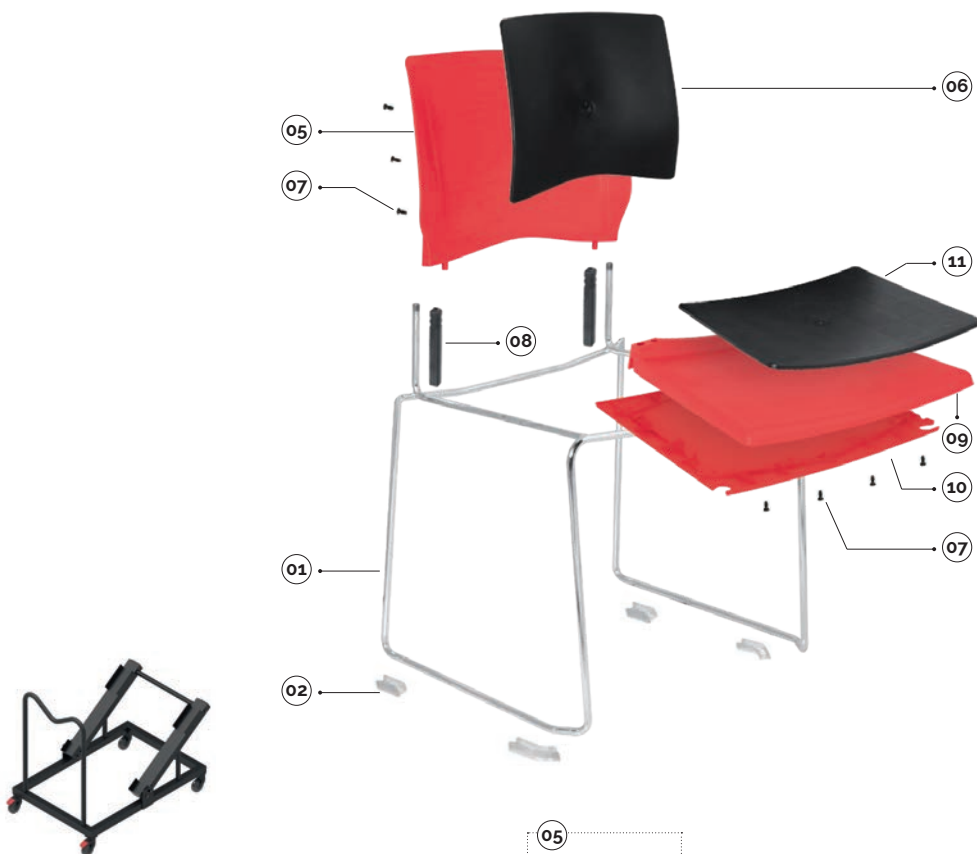

x3-chariot porte-chaises avec accessoires
x3-carro para sillas con accesorios

code	finishing	q.kit	kg.x1
110803-346	● noir/negro	x1	10,50

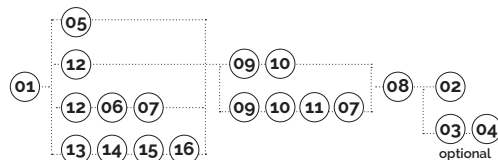

plastic colours

- gris/gris ral 7003
- noir/negro
- rouge/rojo 527
- blanc/blanco ral 1013

main component sizes

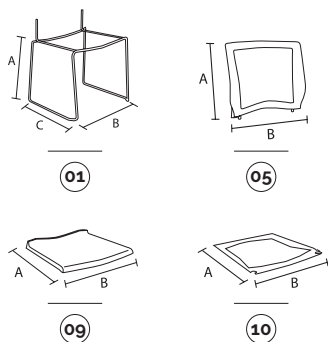

optionnals

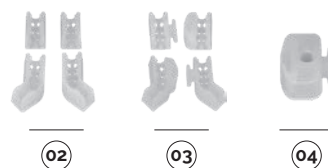

01 x3-base coulissante tige d.12 x3-base patin de varilla d.12

code	finishing	q.kit	q.pack	a	b	c	kg.x1	vol.x1
113410-062	● chromé/cromado	x1	60	450	530	505	4,20	mc. 0.03

02 btf-kit pieds btf-kit pies

code	finishing	q.kit	q.pack	kg.x1
134306-001	○ neutre/neutro	x1	100	0,05

03 btf-kit pieds avec crochets btf-kit pies con ganchos

code	finishing	q.kit	q.pack	kg.x1
134306-002	○ neutre/neutro	x1	100	0,06

04 pptf-embout pour fixation au sol pptf-tapón para fijación en el pavimento

code	finishing	q.kit	q.pack	kg.x1
134306-003	○ neutre/neutro	x2	100	0,03

05 x3-dossier coloré en plastique plein x3-respaldo de color de plástico lleno

code	finishing	q.kit	q.pack	a	b	kg.x1	vol.x1
132102-090	● rouge/rojo	x1	10	400	460	0,90	mc. 0.008

08 x3-adaptateur pour dossier en plastique x3-adaptador para respaldo de plástico

code	finishing	q.kit	q.pack	kg.x1	vol.x1
132103-009	● noir/negro	x2	200	0,019	mc. 0.0001

09 x3-siège coloré en plastique pour châssis coulissant x3-asiento de color de plástico para estructura patin

code	finishing	q.kit	q.pack	a	b	kg.x1	vol.x1
132202-019	● rouge/rojo	x1	10	450	460	1,20	mc. 0.015

10 x3-renfort d'assise en plastique coloré x3-parte inferior asiento de color base de plástico

code	finishing	q.kit	q.pack	a	b	kg.x1	vol.x1
132202-009	● rouge/rojo	x1	20	450	460	0,73	mc. 0.007



for all colour codes, see page 93

X3

slide/backrest and seat options

main component sizes

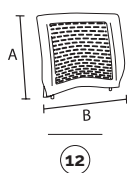

12



CERTIFIED BY
BIFMA

- 12 x3-dossier coloré en plastique à trous
x3-respaldo de color base de plástico perforado

code	finishing	q.kit	q.pack	a	b	kg.x1	vol.x1
132102-019	● rouge/rojo 527	x1	10	400	460	0,90	mc. 0.008

and · 09 10

main component sizes

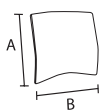

06



- 06 x3-panneau dossier à revêtir en plastique
x3-panel respaldo tapizable de plástico

code	finishing	q.kit	q.pack	a	b	kg.x1	vol.x1
132103-008	● noir/negro	x1	20	350	385	0,50	mc. 0.003

- 11 x3-panneau assise à revêtir en plastique
x3-galleta asiento tapizable de plástico

code	finishing	q.kit	q.pack	a	b	kg.x1	vol.x1
132203-003	● noir/negro	x1	20	400	410	0,60	mc. 0.003

- 07 vis hilo tb+ 5x12 cimentée brunie noire
tornillo hilo tb+ 5x12 cementado bruñido negro

code	finishing	q.kit seat	q.kit back
117803-154	● noir/negro	x8	x6

and · 12 09 10

main component sizes

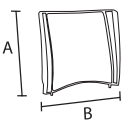

13



- 13 x3-dossier pour treillis noir en plastique
x3-respaldo para malla negro base de plástico

code	finishing	q.kit	q.pack	a	b	kg.x1	vol.x1
132103-014	● noir/negro	x1	10	400	460	0,60	mc. 0.008

- 14 x3-bandes a+b pour dossier treillis noir
x3-listones a+b para respaldo malla negros base

code	finishing	q.kit	q.pack	kg.x1	vol.x1
132103-013	● noir/negro	x1	100	0,21	mc. 0.0004

- 15 x3-treillis pour dossier
x3-malla para respaldo

code	finishing	q.kit	q.pack	a	b	kg.x1	vol.x1
132103-029	● noir/negro	x1	50	400	460	0,14	mc. 0.0057

- 16 vis médium tsp+ ø3,5x10 brunie noire (pour fixer dossier treillis)
tornillo para panel de aglomerado tsp+ d.3,5x10 bruñido negro (para fijar respaldo malla)

code	finishing	q.kit
117803-105	● noir/negro	x8

and · 09 10 11 07

X3

slide w/writing tablet

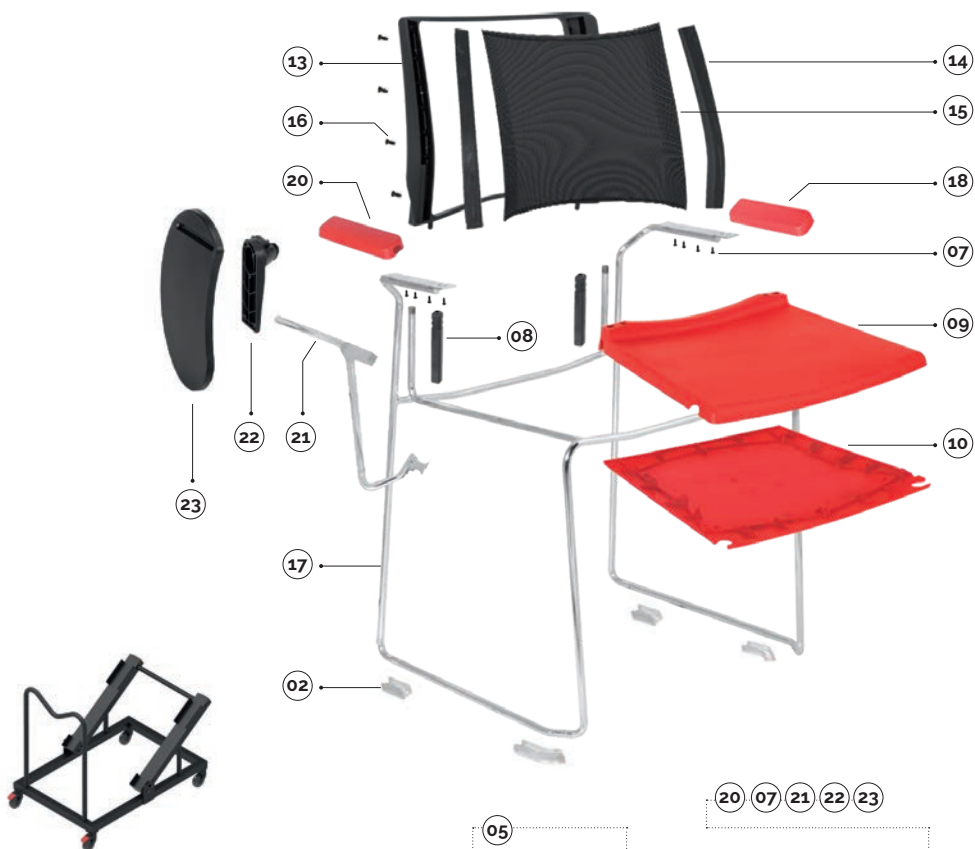

plastic colours

- gris/gris ral 7003
- noir/negro
- rouge/rojo 527
- blanc/blanco ral 1013

x3-chariot porte-chaises avec accessoires
x3-carro para sillas con accesorios

code	finishing	q.kit	kg.x1
110803-346	● noir/negro	x1	10,50

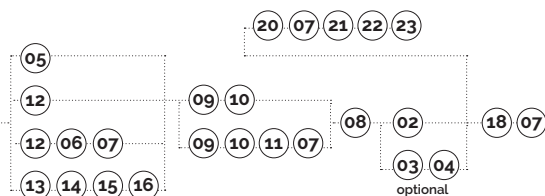

main component sizes

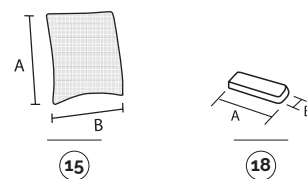
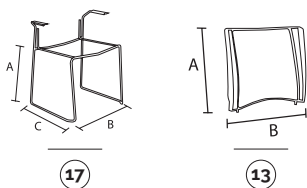

optionals

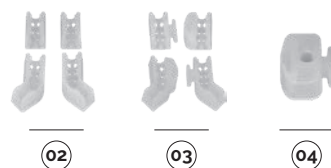

17 x3-châssis coulissant tige d.12 avec accoudoirs
x3-estructura patin de varilla d. 12 con brazos

code	finishing	q.kit	q.pack	a	b	c	kg.x1	vol.x1
113410-061	● chromé/cromado	x1	60	450	530	505	5,00	mc. 0.035

13 x3-dossier pour treillis noir en plastique
x3-respaldo para malla negro base de plástico

code	finishing	q.kit	q.pack	a	b	kg.x1	vol.x1
132103-014	● noir/negro	x1	10	400	460	0,60	mc. 0.008

14 x3-bandes a+b pour dossier treillis noir
x3-listones a+b para respaldo malla negro base

code	finishing	q.kit	q.pack	kg.x1	vol.x1
132103-013	● noir/negro	x1	100	0,21	mc. 0.0004

15 x3-treillis pour dossier
x3-malla para respaldo

code	finishing	q.kit	q.pack	a	b	kg.x1	vol.x1
132103-029	● noir/negro	x1	50	400	460	0,14	mc. 0.0057

16 vis médium tsp* ø3,5x10 brunie noire (pour fixer dossier treillis)
tornillo para panel de aglomerado tsp* d.3,5x10 bruñido negro (para fijar respaldo malla)

code	finishing	q.kit
117803-105	● noir/negro	x8

18 x3-accoudoir plastique coloré pour châssis fl
x3-brazo de plástico de color para estructura patin de varilla

code	finishing	q.kit	q.pack	a	b	kg.x1	vol.x1	
131702-019	● rouge/rojo	527	x2	40	175	55	0,10	mc. 0.0004

07 vis hilo tb* 5x12 cimentée brunie noire
tornillo hilo tb* 5x12 cementado bruñido negro

code	finishing	q.kit seat	q.kit back
117803-154	● noir/negro	x8	x6

for the components below, see page 78

02 03 04 08 09 10



for all colour codes, see page 93

X3

slide/tablet accessories

main component sizes

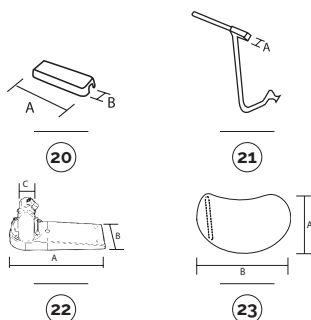

20 X3-accouidoir plastique coloré pour châssis fil avec tablette X3-brazo de plástico de color para estructura patin de varilla con pala

code	finishing		q.kit	q.pack	a	b	kg.x1	vol.x1
131702-018	● rouge/rojo	527	x2	40	175	55	0,10	mc. 0,0004

21 X3-support tablette pour coulisse + vis X3-soporte pala para patin + tornillos

code	finishing		q.kit	q.pack		kg.x1	vol.x1
111703-044	● noir/negro	droite/derecha-coulisse/patin	x1	10	15x15	0,60	mc. 0,002
111703-047	● noir/negro	gauche/izquierda-coulisse/patin	x1	10	15x15	0,60	mc. 0,002
111710-044	● chromé/cromado	droite/derecha-coulisse/patin	x1	10	15x15	0,60	mc. 0,002
111710-047	● chromé/cromado	gauche/izquierda-coulisse/patin	x1	10	15x15	0,60	mc. 0,002

22 spt2-rotule pour tablette en plastique spt2-articulación para pala de plástico

code	finishing		q.kit	q.pack	a	b	c	kg.x1	vol.x1
134003-039	● noir/negro		x1	20	180	66	15x15	0,35	mc. 0,0006

23 bean-tablette en thermoplastique épaisseur 16 mm bean-pala de termoplástico grosor 16 mm

code	finishing		q.kit	q.pack	a	b	kg.x1	vol.x1
134003-044	● noir/negro		x1	20	235	370	0,40	mc. 0,002



for writing tablet options, see page 192/193

slide w/armrests/backrest and seat options

main component sizes

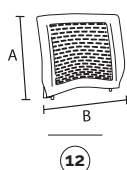

12 X3-dossier coloré en plastique à trous X3-respaldo de color base de plástico perforado

code	finishing		q.kit	q.pack	a	b	kg.x1	vol.x1
132102-019	● rouge/rojo	527	x1	10	400	460	0,90	mc. 0,008

and · (09) (10)

main component sizes

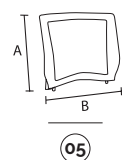

05 X3-dossier coloré en plastique plein X3-respaldo de color de plástico lleno

code	finishing		q.kit	q.pack	a	b	kg.x1	vol.x1
132102-090	● rouge/rojo	527	x1	10	400	460	0,90	mc. 0,008

and · (09) (10)

main component sizes

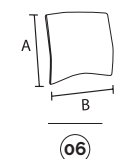

06 X3-panneau dossier à revêtir en plastique X3-panel respaldo tapizable de plástico

code	finishing		q.kit	q.pack	a	b	kg.x1	vol.x1
132103-008	● noir/negro		x1	20	350	385	0,50	mc. 0,003

11 X3-panneau assise à revêtir en plastique X3-galleta asiento tapizable de plástico

code	finishing		q.kit	q.pack	a	b	kg.x1	vol.x1
132203-003	● noir/negro		x1	20	400	410	0,60	mc. 0,003

07 vis hilo tb+ 5x12 cimentée brunie noire tornillo hilo tb+ 5x12 cementado bruniado negro

code	finishing		q.kit seat	q.kit back
117803-154	● noir/negro		x8	x6

and · (12) (09) (10)

X3

4-legs

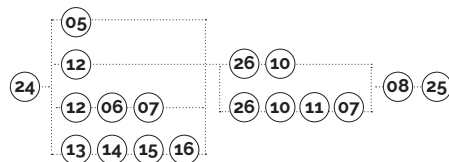
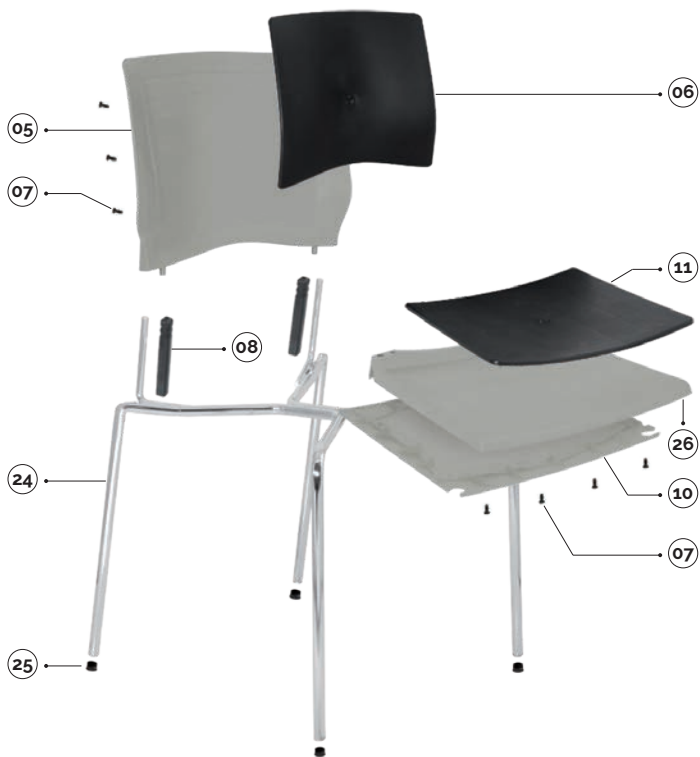

plastic colours

- gris/gris ral 7003
- noir/negro
- rouge/rojo 527
- blanc/blanco ral 1013

x3-chaïot porte-chaises avec accessoires
x3-carro para sillas con accesorios

code	finishing	q.kit	kg.x1
110803-346	● noir/negro	x1	10,50

main component sizes

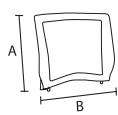
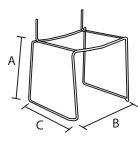

24 x3-châssis 4 pieds d.18
x3-estructura 4 patas d.18

code	finishing	q.kit	q.pack	a	b	c	kg.x1	vol.x1
112703-050	● noir/negro	x1	60	455	465	550	2,20	mc. 0.03
112704-050	● gris/gris	x1	60	455	465	550	2,20	mc. 0.03
112710-050	● chromé/cromado	x1	60	455	465	550	2,20	mc. 0.03

25 pack embouts ronds d.18 noirs
paquete de tacos redondos d.18 negros

code	finishing	q.kit	q.pack
137003-072	● noir/negro	x4	200

05 x3-dossier coloré en plastique plein
x3-respaldo de color de plástico lleno

code	finishing	q.kit	q.pack	a	b	kg.x1	vol.x1
132104-090	● gris/gris	x1	10	400	460	0,90	mc. 0.008

08 x3-adaptateur pour dossier en plastique
x3-adaptador para respaldo de plástico

code	finishing	q.kit	q.pack	kg.x1	vol.x1
132103-009	● noir/negro	x2	200	0,019	mc. 0.0001

26 x3-siège coloré en plastique pour châssis 4 pieds
x3-asiento de color base de plástico para estructura 4 patas

code	finishing	q.kit	q.pack	a	b	kg.x1	vol.x1
132204-018	● gris/gris	x1	10	450	460	1,20	mc. 0.015

10 x3-renfort d'assise en plastique coloré
x3-partie inferior asiento de color base de plástico

code	finishing	q.kit	q.pack	a	b	kg.x1	vol.x1
132204-009	● gris/gris	x1	20	450	460	0,73	mc. 0.007



for all colour codes, see page 93

X3

4-legs/backrest and seat options

main component sizes

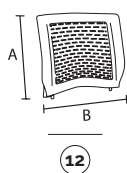

- 12** x3-dossier coloré en plastique à trous
x3-respaldo de color base de plástico perforado

code	finishing	q.kit	q.pack	a	b	kg.x1	vol.x1
132102-019	● rouge/rojo 527	x1	10	400	460	0,90	mc. 0.008

and · **26** **10**

main component sizes

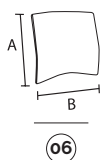

- 06** x3-panneau dossier à revêtir en plastique
x3-panel respaldo tapizable de plástico

code	finishing	q.kit	q.pack	a	b	kg.x1	vol.x1
132103-008	● noir/negro	x1	20	350	385	0,50	mc. 0.003

- 11** x3-panneau assise à revêtir en plastique
x3-galleta asiento tapizable de plástico

code	finishing	q.kit	q.pack	a	b	kg.x1	vol.x1
132203-003	● noir/negro	x1	20	400	410	0,60	mc. 0.003

- 07** vis hilo tb+ 5x12 cimentée brunie noire
tornillo hilo tb+ 5x12 cementado bruñido negro

code	finishing	q.kit seat	q.kit back
117803-154	● noir/negro	x8	x6

and · **12** **26** **10**

main component sizes

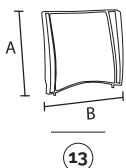

- 13** x3-dossier pour treillis noir en plastique
x3-respaldo para malla negro base de plástico

code	finishing	q.kit	q.pack	a	b	kg.x1	vol.x1
132103-014	● noir/negro	x1	10	400	460	0,60	mc. 0.008

- 14** x3-bandes a+b pour dossier treillis noir
x3-listones a+b para respaldo malla negros base

code	finishing	q.kit	q.pack	kg.x1	vol.x1
132103-013	● noir/negro	x1	100	0,21	mc. 0.0004

- 15** x3-treillis pour dossier
x3-malla para respaldo

code	finishing	q.kit	q.pack	a	b	kg.x1	vol.x1
132103-029	● noir/negro	x1	50	400	460	0,14	mc. 0.0057

- 16** vis médium tsp+ ø3,5x10 brunie noire (pour fixer dossier treillis)
tornillo para panel de aglomerado tsp+ d.3,5x10 bruñido negro (para fijar respaldo malla)

code	finishing	q.kit
117803-105	● noir/negro	x8

and · **26** **10** **11** **07**

X3

4-legs w/writing tablet

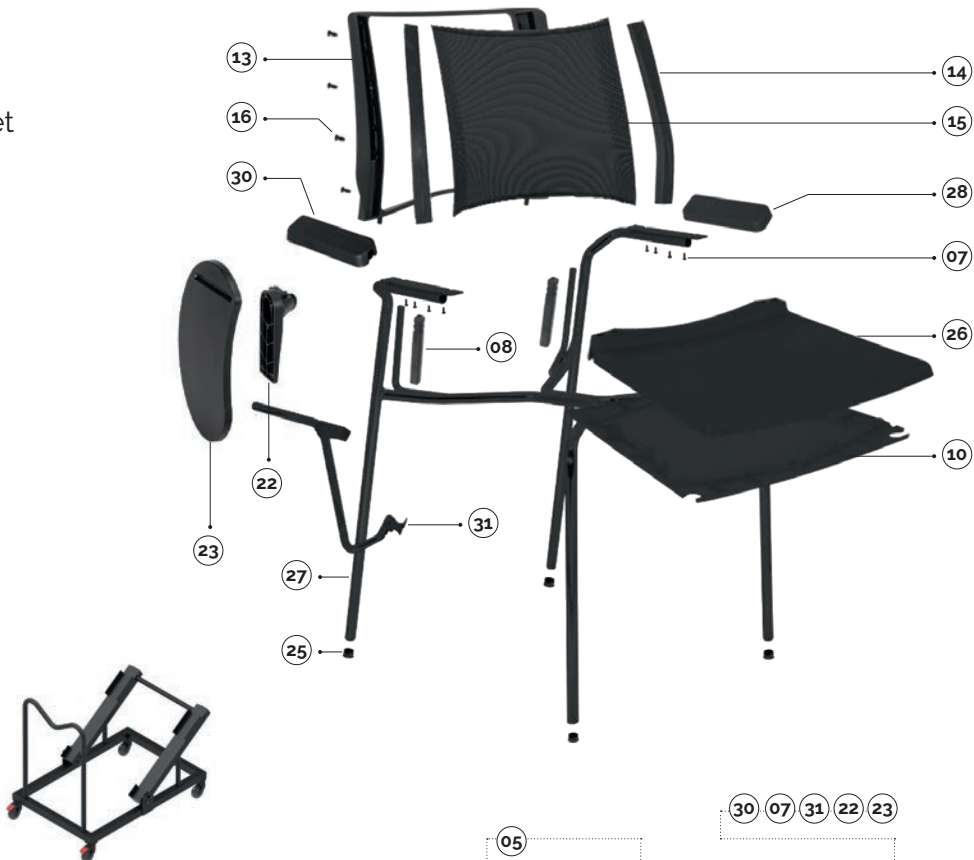

plastic colours

- gris/gris ral 7003
- noir/negro
- rouge/rojo 527
- blanc/blanco ral 1013

x3-chaîss 4 pieds d.18 avec accoudoirs
x3-carro para sillas con accesorios

code	finishing	q.kit	kg.x1
110803-346	● noir/negro	x1	10,50

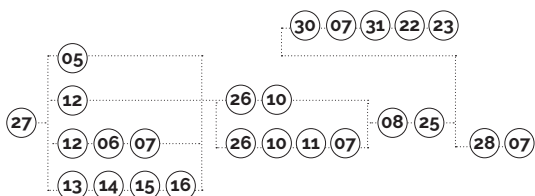

main component sizes

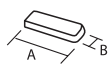
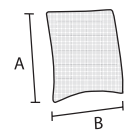
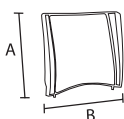
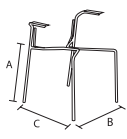

27 X3-châssis 4 pieds d.18 avec accoudoirs

x3-estructura 4 patas d. 18 con brazos

code	finishing	q.kit	q.pack	a	b	c	kg.x1	vol.x1
112703-051	● noir/negro	x1	60	455	465	550	2,80	mc. 0.035
112704-051	● gris/gris	x1	60	455	465	550	2,80	mc. 0.035
112710-054	● chromé/cromado	x1	60	455	465	550	2,80	mc. 0.035

13 X3-dossier pour treillis noir en plastique

x3-respaldo para malla negro base de plástico

code	finishing	q.kit	q.pack	a	b	kg.x1	vol.x1
132103-014	● noir/negro	x1	10	400	460	0,60	mc. 0.008

14 X3-bandes a+b pour dossier treillis noir

x3-listones a+b para respaldo malla negro base

code	finishing	q.kit	q.pack	kg.x1	vol.x1
132103-013	● noir/negro	x1	100	0,21	mc. 0.0004

15 X3-treillis pour dossier

x3-malla para respaldo

code	finishing	q.kit	q.pack	a	b	kg.x1	vol.x1
132103-029	● noir/negro	x1	50	400	460	0,14	mc. 0.0057

16 vis médium tsp+ ø3,5x10 brunie noire (pour fixer dossier treillis)

tornillo para panel de aglomerado tsp+ d.3,5x10 bruñido negro (para fijar respaldo malla)

code	finishing	q.kit
117803-105	● noir/negro	x8

28 X3-accoudoir plastique coloré pour châssis 4 pieds

x3-brazo de plástico de color para estructura 4 patas

code	finishing	q.kit	q.pack	a	b	kg.x1	vol.x1
131703-017	● noir/negro	x2	40	175	55	0,10	mc. 0.0004

07 vis hilo tb+ 5x12 cimentée brunie noire

tornillo hilo tb+ 5x12 cementado bruñido negro

code	finishing	q.kit seat	q.kit back
117803-154	● noir/negro	x8	x6

for the components below, see page 82



for all colour codes, see page 93

25 08 26 10

X3

4-legs/tablet accessories

main component sizes

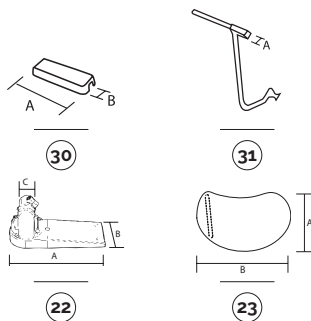

30 X3-accoudoir plastique coloré pour châssis 4 pieds avec tablette X3-brazo de plástico de color para estructura de 4 patas con pala

code	finishing	q.kit	q.pack	a	b	kg.x1	vol.x1
131703-014	● noir/negro	x2	40	175	55	0,10	mc. 0,0004

31 X3-support tablette pour 4 pieds + vis X3-soporte pala para 4 patas + tornillos

code	finishing	q.kit	q.pack	kg.x1	vol.x1
111703-043	● noir/negro droite/derecha-4 pieds/4 patas x1	10	15x15	0,60	mc. 0,002
111703-046	● noir/negro gauche/izquierda-4 pieds/4 patas x1	10	15x15	0,60	mc. 0,002
111710-037	● chromé/cromado droite/derecha-4 pieds/4 patas x1	10	15x15	0,60	mc. 0,002
111710-039	● chromé/cromado gauche/izquierda-4 pieds/4 patas x1	10	15x15	0,60	mc. 0,002

22 spt2-rotule pour tablette en plastique spt2-articulación para pala de plástico

code	finishing	q.kit	q.pack	a	b	c	kg.x1	vol.x1
134003-039	● noir/negro	x1	20	180	66	15x15	0,35	mc. 0,0006

23 bean-tablette en thermoplastique épaisseur 16 mm bean-pala de termoplástico grosor 16 mm

code	finishing	q.kit	q.pack	a	b	kg.x1	vol.x1
134003-044	● noir/negro	x1	20	235	370	0,40	mc. 0,002



for writing tablet options, see page 192/193

4-legs w/armrests/backrest and seat options

main component sizes

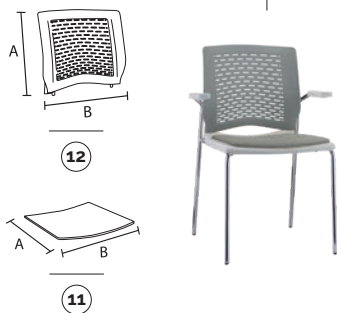

CERTIFIED BY
BIFMA

12 X3-dossier coloré en plastique à trous X3-respaldo de color base de plástico perforado

code	finishing	q.kit	q.pack	a	b	kg.x1	vol.x1
132104-019	● gris/gris ral 7003	x1	10	400	460	0,90	mc. 0,008

11 X3-panneau assise à revêtir en plastique X3-galleta asiento tapizable de plástico

code	finishing	q.kit	q.pack	a	b	kg.x1	vol.x1
132203-003	● noir/negro	x1	20	400	410	0,60	mc. 0,003

07 vis hilo tb+ 5x12 cimentée brunie noire tornillo hilo tb+ 5x12 cementado bruñido negro

code	finishing	q.kit seat	q.kit back
117803-154	● noir/negro	x8	x6

and **26** **10**

main component sizes

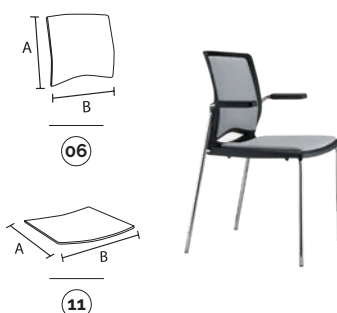

06 X3-panneau dossier à revêtir en plastique X3-panel respaldo tapizable de plástico

code	finishing	q.kit	q.pack	a	b	kg.x1	vol.x1
132103-008	● noir/negro	x1	20	350	385	0,50	mc. 0,003

11 X3-panneau assise à revêtir en plastique X3-galleta asiento tapizable de plástico

code	finishing	q.kit	q.pack	a	b	kg.x1	vol.x1
132203-003	● noir/negro	x1	20	400	410	0,60	mc. 0,003

07 vis hilo tb+ 5x12 cimentée brunie noire tornillo hilo tb+ 5x12 cementado bruñido negro

code	finishing	q.kit seat	q.kit back
117803-154	● noir/negro	x8	x6

and **12** **26** **10**

X3

swivel



plastic colours

- gris/gris ral 7003
- noir/negro
- rouge/rojo 527
- blanc/blanco ral 1013

main component sizes



32

33

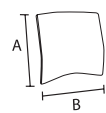
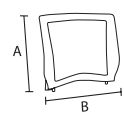

05

06

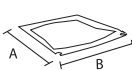

09

10

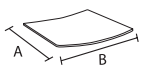

11

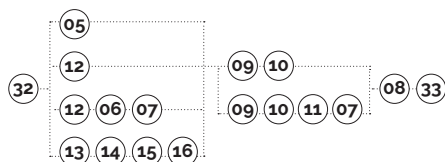

32 x3-support pivotant au gaz
x3-soporte versión giratoria con mecanismo de gas

code	finishing	q.kit	q.pack	kg.x1	vol.x1
110903-028	● noir/negro	x1	100	3,00	mc. 0,02
110904-014	● gris/gris	x1	100	3,00	mc. 0,02

33 b40-base en métal avec cache-soudure
b40-base de metal con embellecedor soldadura

code	finishing	q.kit	q.pack	a	ø	kg.x1	vol.x1
110210-027	● chromé/cromado	x1	5	60	640	2,85	mc. 0,014

05 x3-dossier coloré en plastique plein
x3-respaldo de color de plástico lleno

code	finishing	q.kit	q.pack	a	b	kg.x1	vol.x1
132105-090	○ blanc/blanco ral 1013	x1	10	400	460	0,90	mc. 0,008

06 x3-panneau dossier à revêtir en plastique
x3-panel respaldo tapizable de plástico

code	finishing	q.kit	q.pack	a	b	kg.x1	vol.x1
132103-008	● noir/negro	x1	20	350	385	0,50	mc. 0,003

07 vis hilo tb+ 5x12 cimentée brunie noire
tornillo hilo tb+ 5x12 cementado brunido negro

code	finishing	q.kit seat	q.kit back
117803-154	● noir/negro	x8	x6

08 x3-adaptateur pour dossier en plastique
x3-adaptador para respaldo de plástico

code	finishing	q.kit	q.pack	kg.x1	vol.x1
132103-009	● noir/negro	x2	200	0,019	mc. 0,0001

09 x3-siège coloré en plastique pour châssis coulissant
x3-asiento de color de plástico para estructura patin

code	finishing	q.kit	q.pack	a	b	kg.x1	vol.x1
132205-019	○ blanc/blanco ral 1013	x1	10	450	460	1,20	mc. 0,015

10 x3-renfort d'assise en plastique coloré
x3-parte inferior asiento de color base de plástico

code	finishing	q.kit	q.pack	a	b	kg.x1	vol.x1
132205-009	○ blanc/blanco ral 1013	x1	20	450	460	0,73	mc. 0,007

11 x3-panneau assise à revêtir en plastique
x3-galleta asiento tapizable de plástico

code	finishing	q.kit	q.pack	a	b	kg.x1	vol.x1
132203-003	● noir/negro	x1	20	400	410	0,60	mc. 0,003



X3

swivel/backrest and seat options

main component sizes

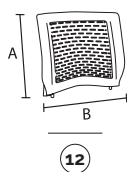

12 X3-dossier coloré en plastique à trous
X3-respaldo de color base de plástico perforado

code	finishing	q.kit	q.pack	a	b	kg.x1	vol.x1
132105-019	O blanc/blanco ral 1013	x1	10	400	460	0,90	mc. 0,008

and · **09** **10**

main component sizes

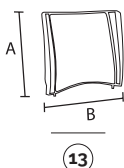

13 X3-dossier pour treillis noir en plastique
X3-respaldo para malla negro base de plástico

code	finishing	q.kit	q.pack	a	b	kg.x1	vol.x1
132103-014	● noir/negro	x1	10	400	460	0,60	mc. 0,008

14 X3-bandes a+b pour dossier treillis noir
X3-listones a+b para respaldo malla negros base

code	finishing	q.kit	q.pack	kg.x1	vol.x1
132103-013	● noir/negro	x1	100	0,21	mc. 0,0004

15 X3-treillis pour dossier
X3-malla para respaldo

code	finishing	q.kit	q.pack	a	b	kg.x1	vol.x1
132103-029	● noir/negro	x1	50	400	460	0,14	mc. 0,0057

16 vis médium tsp* ø3,5x10 brunie noire (pour fixer dossier treillis)
tornillo para panel de aglomerado tsp* d.3,5x10 bruñido negro (para fijar respaldo malla)

code	finishing	q.kit
117803-105	● noir/negro	x8

and · **09** **10** **11** **07**

X3

swivel w/armrests



plastic colours

- gris/gris ral 7003
- noir/negro
- rouge/rojo 527
- blanc/blanco ral 1013

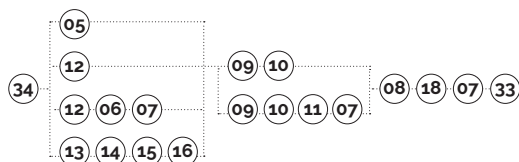

main component sizes

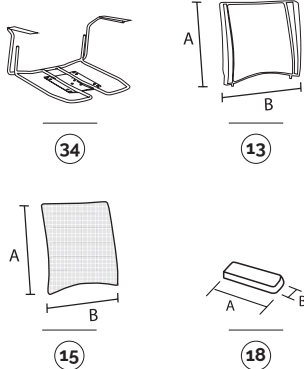

34 x3-châssis pivotant au gaz avec accoudoirs
x3-estructura versión giratoria con mecanismo de gas y brazos

code	finishing	q.kit	q.pack	kg.x1	vol.x1
110903-027	● noir/negro	x1	100	4,00	mc. 0,02
110904-015	● gris/gris	x1	100	4,00	mc. 0,02
110910-015	● chromé/cromado	x1	100	4,00	mc. 0,02

13 x3-dossier pour treillis noir en plastique
x3-respaldo para malla negro base de plástico

code	finishing	q.kit	q.pack	a	b	kg.x1	vol.x1
132103-014	● noir/negro	x1	10	400	460	0,60	mc. 0,008

14 x3-bandes a+b pour dossier treillis noir
x3-listones a+b para respaldo malla negros base

code	finishing	q.kit	q.pack	kg.x1	vol.x1
132103-013	● noir/negro	x1	100	0,21	mc. 0,0004

15 x3-treillis pour dossier
x3-malla para respaldo

code	finishing	q.kit	q.pack	a	b	kg.x1	vol.x1
132103-029	● noir/negro	x1	50	400	460	0,14	mc. 0,0057

16 vis médium tsp+ ø3,5x10 brunie noire (pour fixer dossier treillis)
tornillo para panel de aglomerado tsp+ d.3,5x10 bruñido negro (para fijar respaldo malla)

code	finishing	q.kit
117803-105	● noir/negro	x8

18 x3-accoudoir plastique coloré pour châssis fl
x3-brazo de plástico de color para estructura patin de varilla

code	finishing	q.kit	q.pack	a	b	kg.x1	vol.x1
131703-019	● noir/negro	x2	40	175	55	0,10	mc. 0,0004

07 vis hilo tb+ 5x12 cimentée brunie noire
tornillo hilo tb+ 5x12 cementado bruñido negro

code	finishing	q.kit seat	q.kit back
117803-154	● noir/negro	x8	x6

for the components below, see page 86



for all colour codes, see page 93

33 08 09 10

X3

swivel w/armrests/backrest and seat options

main component sizes

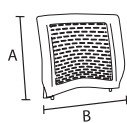

12



12 x3-dossier coloré en plastique à trous
x3-respaldo de color base de plástico perforado

code	finishing	q.kit	q.pack	a	b	kg.x1	vol.x1
132104-019	● gris/gris ral 7003	x1	10	400	460	0,90	mc. 0,008

and · **09** **10**

main component sizes

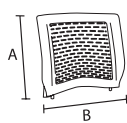

12

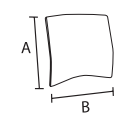

06

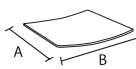

11



12 x3-dossier coloré en plastique à trous
x3-respaldo de color base de plástico perforado

code	finishing	q.kit	q.pack	a	b	kg.x1	vol.x1
132105-019	○ blanc/blanco ral 1013	x1	10	400	460	0,90	mc. 0,008

06 x3-panneau dossier à revêtir en plastique
x3-panel respaldo tapizable de plástico

code	finishing	q.kit	q.pack	a	b	kg.x1	vol.x1
132103-008	● noir/negro	x1	20	350	385	0,50	mc. 0,003

11 x3-panneau assise à revêtir en plastique
x3-galleta asiento tapizable de plástico

code	finishing	q.kit	q.pack	a	b	kg.x1	vol.x1
132203-003	● noir/negro	x1	20	400	410	0,60	mc. 0,003

07 vis hilo tb+ 5x12 cimentée brunie noire
tornillo hilo tb+ 5x12 cementado bruñido negro

code	finishing	q.kit seat	q.kit back
117803-154	● noir/negro	x8	x6

and · **09** **10**

X3 bench

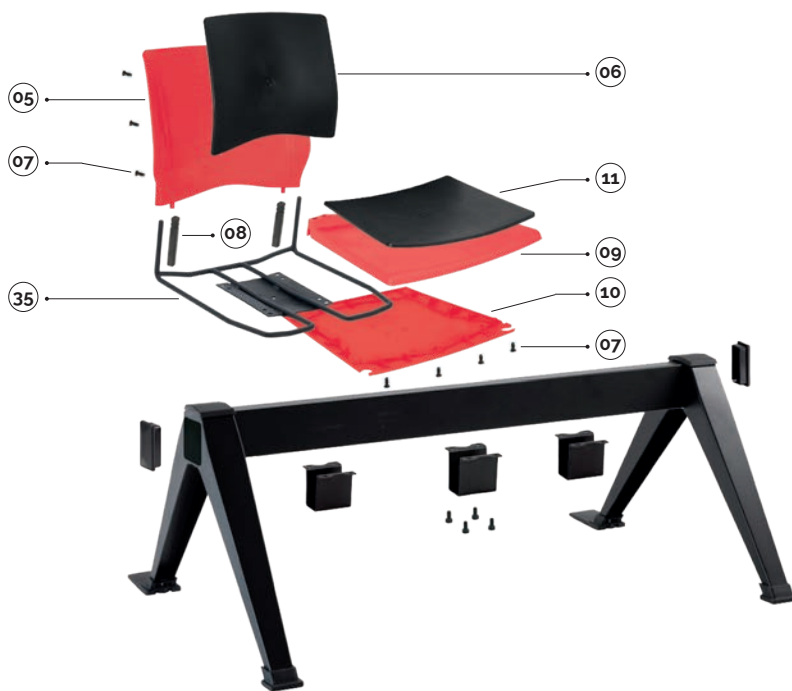

plastic colours

- gris/gris ral 7003
- noir/negro
- rouge/rojo 527
- blanc/blanco ral 1013

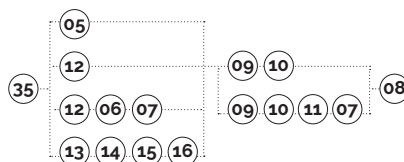

main component sizes

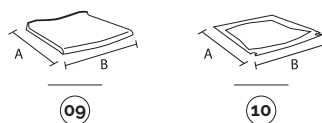
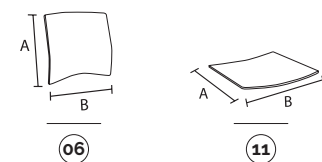
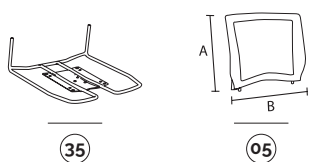

35 x3-châssis pour banquette x3-estructura para bancada

code	finishing	q.kit	q.pack	kg.x1	vol.x1
110703-041	● noir/negro	x1	100	2,70	mc. 0,02
110704-039	● gris/gris	x1	100	2,70	mc. 0,02

05 x3-dossier coloré en plastique plein x3-respaldo de color de plástico lleno

code	finishing	q.kit	q.pack	a	b	kg.x1	vol.x1
132102-090	● rouge/rojo 527	x1	10	400	460	0,90	mc. 0,008

06 x3-panneau dossier à revêtir en plastique x3-panel respaldo tapizable de plástico

code	finishing	q.kit	q.pack	a	b	kg.x1	vol.x1
132103-008	● noir/negro	x1	20	350	385	0,50	mc. 0,003

07 vis hilo tb+ 5x12 cimentée brunie noire tornillo hilo tb+ 5x12 cementado brunido negro

code	finishing	q.kit seat	q.kit back
117803-154	● noir/negro	x8	x6

08 x3-adaptateur pour dossier en plastique x3-adaptador para respaldo de plástico

code	finishing	q.kit	q.pack	kg.x1	vol.x1
132103-009	● noir/negro	x2	200	0,019	mc. 0,0001

09 x3-siège coloré en plastique pour châssis coulissant x3-asiento de color de plástico para estructura patin

code	finishing	q.kit	q.pack	a	b	kg.x1	vol.x1
132202-019	● rouge/rojo 527	x1	10	450	460	1,20	mc. 0,015

10 x3-renfort d'assise en plastique coloré x3-parte inferior asiento de color base de plástico

code	finishing	q.kit	q.pack	a	b	kg.x1	vol.x1
132202-009	● rouge/rojo 527	x1	20	450	460	0,73	mc. 0,007

11 x3-panneau assise à revêtir en plastique x3-galleta asiento tapizable de plástico

code	finishing	q.kit	q.pack	a	b	kg.x1	vol.x1
132203-003	● noir/negro	x1	20	400	410	0,60	mc. 0,003

for the bench components, see page 201



for all colour codes, see page 93

X3

bench w/armrests

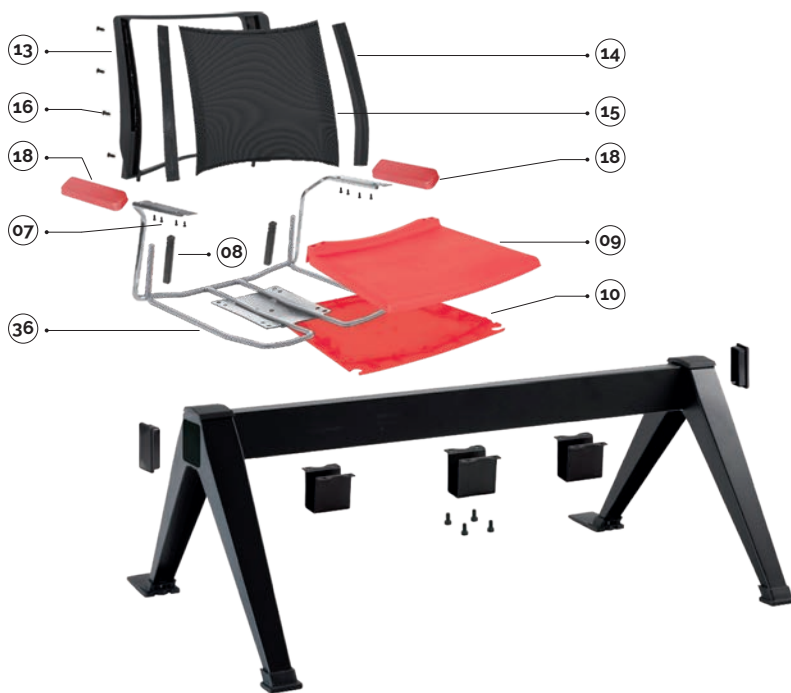

plastic colours

- gris/gris ral 7003
- noir/negro
- rouge/rojo 527
- blanc/blanco ral 1013

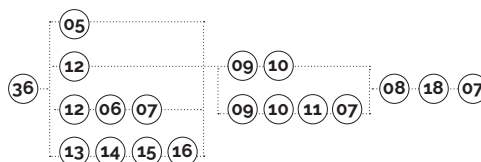

main component sizes

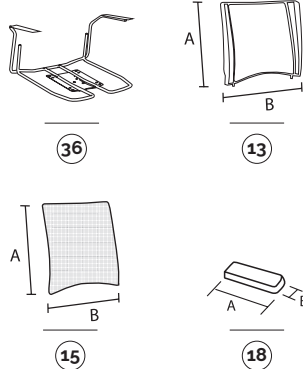

for the components below, see page 90

08 09 10

for all colour codes, see page 93

36 X3-châssis pour banquette avec accoudoirs

X3-estructura para bancada con brazos

code	finishing	q.kit	q.pack	kg.x1	vol.x1
110703-044	● noir/negro	x1	100	3,60	mc. 0,02
110704-210	● gris/gris	x1	100	3,60	mc. 0,02
110710-044	● chromé/cromado	x1	100	3,60	mc. 0,02

13 X3-dossier pour treillis noir en plastique

X3-respaldo para malla negro base de plástico

code	finishing	q.kit	q.pack	a	b	kg.x1	vol.x1
132103-014	● noir/negro	x1	10	400	460	0,60	mc. 0,008

14 X3-bandes a+b pour dossier treillis noir

X3-listones a+b para respaldo malla negro base

code	finishing	q.kit	q.pack	kg.x1	vol.x1
132103-013	● noir/negro	x1	100	0,21	mc. 0,0004

15 X3-treillis pour dossier

X3-malla para respaldo

code	finishing	q.kit	q.pack	a	b	kg.x1	vol.x1
132103-029	● noir/negro	x1	50	400	460	0,14	mc. 0,0057

16 vis médium tsp* ø3,5x10 brunie noire (pour fixer dossier treillis)

tornillo para panel de aglomerado tsp* d.3,5x10 brunido negro (para fijar respaldo malla)

code	finishing	q.kit
117803-105	● noir/negro	x8

18 X3-accoudoir plastique coloré pour châssis fl

X3-brazo de plástico de color para estructura patin de varilla

code	finishing	q.kit	q.pack	a	b	kg.x1	vol.x1
131702-019	● rouge/rojo 527	x2	40	175	55	0,10	mc. 0,0004

07 vis hilo tb* 5x12 cimentée brunie noire

tornillo hilo tb* 5x12 cementado brunido negro

code	finishing	q.kit seat	q.kit back
117803-154	● noir/negro	x8	x6

OPTIONAL bench connector

E-USB NEW bench plug

JIM NEW bench leg

APOLL bench arm

90GM bench leg

90GF bench leg

100GM bench leg

200GM bench leg

PIONEER bench arm

CUT bench leg

SLIM bench leg

CUT bench arm

SLIM bench arm



plastic

metal

aluminium

optionals

X3

bench w/armrests/backrest and seat options

main component sizes

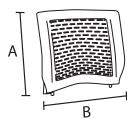

12

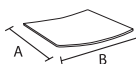

11



- 12 x3-dossier coloré en plastique à trous
x3-respaldo de color base de plástico perforado

code	finishing	q.kit	q.pack	a	b	kg.x1	vol.x1
132104-019	● gris/gris ral 7003	x1	10	400	460	0,90	mc. 0,008

- 11 x3-panneau assise à revêtir en plastique
x3-galleta asiento tapizable de plástico

code	finishing	q.kit	q.pack	a	b	kg.x1	vol.x1
132203-003	● noir/negro	x1	20	400	410	0,60	mc. 0,003

- 07 vis hilo tb+ 5x12 cimentée brunie noire
tornillo hilo tb+ 5x12 cementado bruñido negro

code	finishing	q.kit seat	q.kit back
117803-154	● noir/negro	x8	x6

and · 09 10

main component sizes

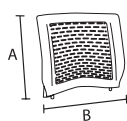

12

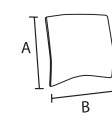

06

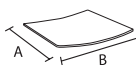

11



- 12 x3-dossier coloré en plastique à trous
x3-respaldo de color base de plástico perforado

code	finishing	q.kit	q.pack	a	b	kg.x1	vol.x1
132105-019	○ blanc/blanco ral 1013	x1	10	400	460	0,90	mc. 0,008

- 06 x3-panneau dossier à revêtir en plastique
x3-panel respaldo tapizable de plástico

code	finishing	q.kit	q.pack	a	b	kg.x1	vol.x1
132103-008	● noir/negro	x1	20	350	385	0,50	mc. 0,003

- 11 x3-panneau assise à revêtir en plastique
x3-galleta asiento tapizable de plástico

code	finishing	q.kit	q.pack	a	b	kg.x1	vol.x1
132203-003	● noir/negro	x1	20	400	410	0,60	mc. 0,003

- 07 vis hilo tb+ 5x12 cimentée brunie noire
tornillo hilo tb+ 5x12 cementado bruñido negro

code	finishing	q.kit seat	q.kit back
117803-154	● noir/negro	x8	x6

and · 09 10

X3

optional colour codes



plastic colour codes



12 dossier en plastique à trous
respaldo de plástico perforado

- 132104-019 gris/gris ral 7003
- 132103-019 noir/negro
- 132102-019 rouge/rojo 527
- 132105-019 blanc/blanco ral 1013



05 dossier en plastique plein
respaldo de plástico lleno

- 132104-090 gris/gris ral 7003
- 132103-090 noir/negro
- 132102-090 rouge/rojo 527
- 132105-090 blanc/blanco ral 1013



09 siège en plastique pour châssis coulissant
asiento de plástico para carcasa patin

- 132204-019 gris/gris ral 7003
- 132203-019 noir/negro
- 132202-019 rouge/rojo 527
- 132205-019 blanc/blanco ral 1013



26 siège en plastique pour châssis 4 pieds
asiento de plástico para estructura 4 patas

- 132204-018 gris/gris ral 7003
- 132203-018 noir/negro
- 132202-018 rouge/rojo 527
- 132205-018 blanc/blanco ral 1013



10 renfort d'assise en plastique
parte inferior asiento de plástico

- 132204-009 gris/gris ral 7003
- 132203-009 noir/negro
- 132202-009 rouge/rojo 527
- 132205-009 blanc/blanco ral 1013



18 accoudoir plastique pour châssis coulissant
brazo de plástico para carcasa patin

- 131704-019 gris/gris ral 7003
- 131703-019 noir/negro
- 131702-019 rouge/rojo 527
- 131705-019 blanc/blanco ral 1013



20 accoudoir plastique pour châssis coulissant avec tablette
brazo de plástico para carcasa patin con pala

- 131704-018 gris/gris ral 7003
- 131703-018 noir/negro
- 131702-018 rouge/rojo 527
- 131705-018 blanc/blanco ral 1013



28 accoudoir plastique pour châssis 4 pieds
brazo de plástico para estructura 4 patas

- 131704-017 gris/gris ral 7003
- 131703-017 noir/negro
- 131702-017 rouge/rojo 527
- 131705-017 blanc/blanco ral 1013



30 accoudoir plastique pour châssis 4 pieds avec tablette
brazo de plástico para estructura 4 patas con pala

- 131704-014 gris/gris ral 7003
- 131703-014 noir/negro
- 131702-014 rouge/rojo 527
- 131705-014 blanc/blanco ral 1013

