

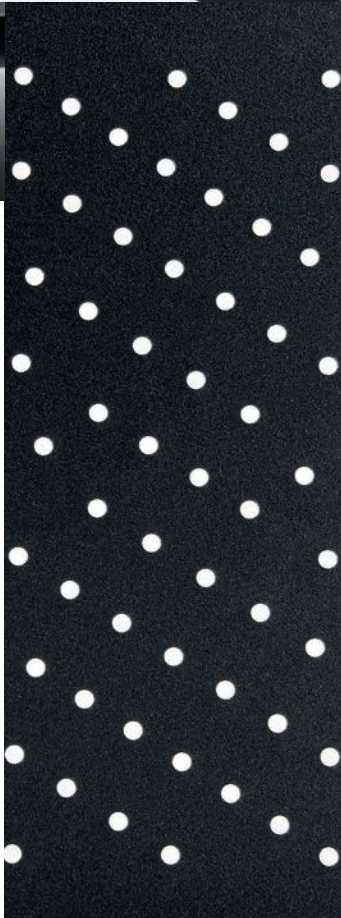

BEYOND **Design**

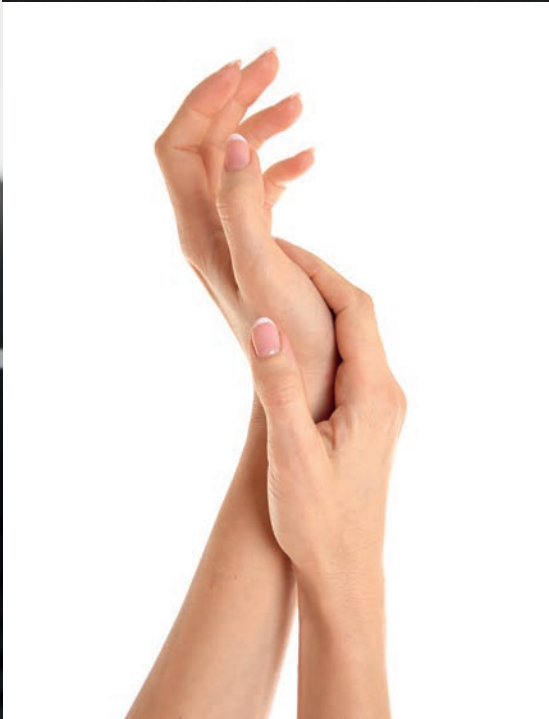



**nexus**



# nexus

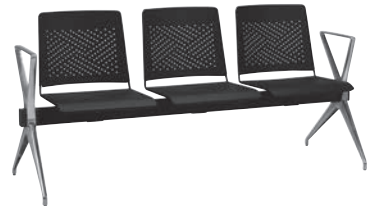
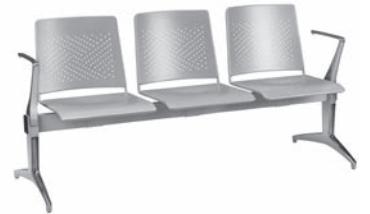

---

slide

4 legs

bench



EN 16139



EN 16139

## nexus showing

### tools



configurator



certification



brochure



video

### features



designed by:  
**esedra &  
alessandrocrosera&partners**



trolley  
available



#### Un banc entièrement métallique.

Une pièce unique au design essentiel, assurant une assise confortable et très stable. Les châssis empilables à 4 pieds et à traîneau complètent la famille.

#### Plus:

- une structure innovante, développée en une seule pièce et entièrement métallique;
- un design caractéristique grâce surtout à sa coque ajourée, entièrement métallique et proposée avec 4 finitions;
- fonctionnelle et facile à nettoyer;
- une qualité certifiée CATAS.

Nexus est parfait pour tous les lieux publics et les salles d'attente.

#### La bancada totalmente metálica.

Una pieza única, con un diseño esencial, que garantiza un asiento cómodo y muy estable. Las 4 estructuras apilables de 4 patas y de patin completan la familia.

#### Pluses:

- estructura innovadora, desarrollada en una única pieza y realizada totalmente en metal;
- diseño distintivo, sobre todo por su carcasa perforada, totalmente realizada en metal y disponible en 4 acabados;
- funcional y fácil de limpiar;
- calidad certificada CATAS.

Nexus es ideal para todos los ambientes de la comunidad y las zonas de espera.



# nexus

## bench

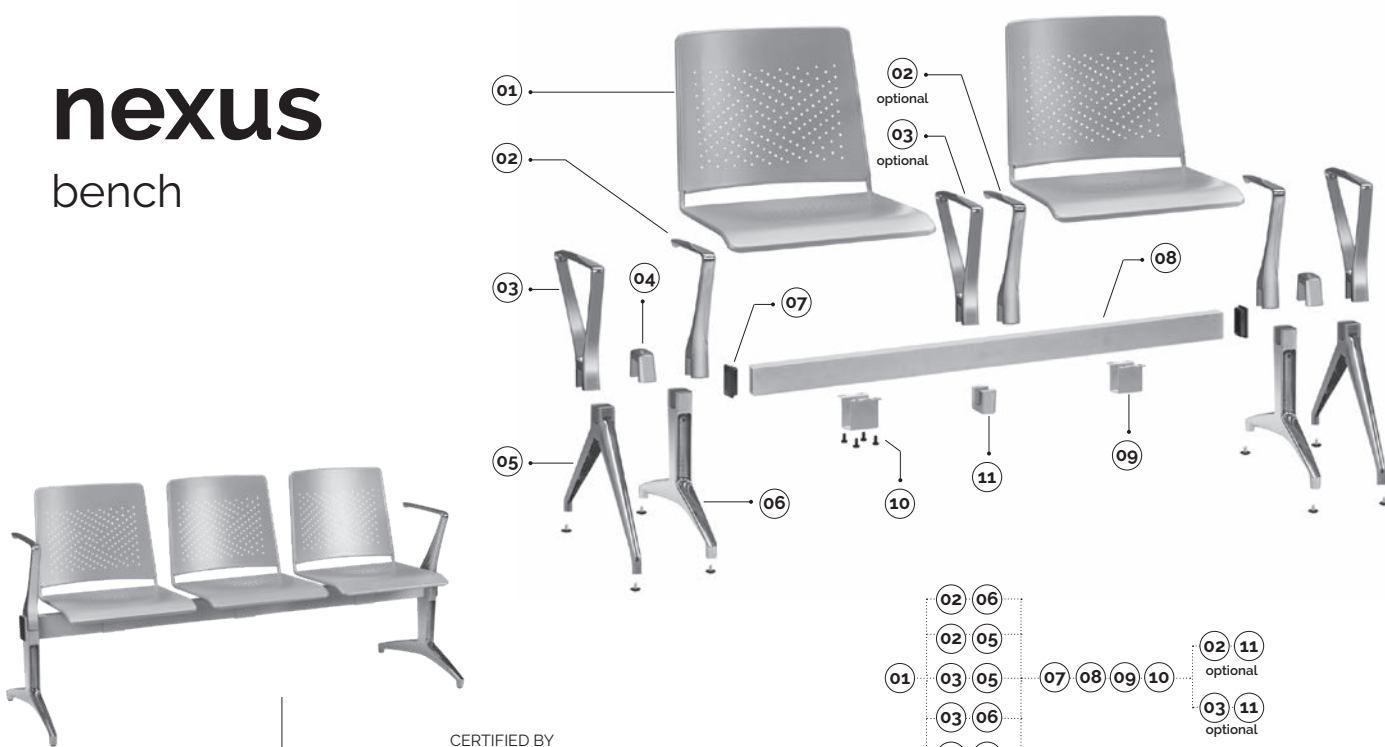

CERTIFIED BY  
**CATAS**

**Corten** • \*Une caractéristique spécifique du Corten est la variabilité dans la tonalité de la finition.  
\* Una característica particular del Corten es las variabilidad en la tonalidad del acabado.

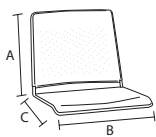

01

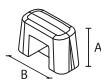

04

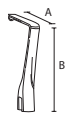

02

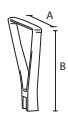

03

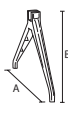

05

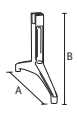

06

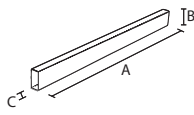

08



09



11

main component sizes

01 nexus-coque en tôle  
nexus-carcasa de chapa

code	finishing	q.kit	q.pack	a	b	c	kg.x1	vol.x1
110703-220	● noir/negro	x1	60	405	454	545	7,60	mc. 0.02
110704-220	● gris/gris	x1	60	405	454	545	7,60	mc. 0.02
110705-220	○ blanc/blanco ral9010	x1	60	405	454	545	7,60	mc. 0.02
110707-220	● corten*	x1	60	405	454	545	7,60	mc. 0.02

02 cut-accoudoir en aluminium pour banquette + 2 vis  
cut-brazo de aluminio para bancada + n.2 tornillos

code	finishing	q.kit	q.pack	a	b	kg.x1	vol.x1
111704-223	● aluminium/aluminio	x1	10	300	305	1,40	mc. 0.0011

03 slim-accoudoir en aluminium pour banquette + 2 vis  
slim-brazo de aluminio para bancada + n.2 tornillos

code	finishing	q.kit	q.pack	a	b	kg.x1	vol.x1
111704-225	● aluminium/aluminio	x1	10	325	305	1,40	mc. 0.0011

04 cut/slim-cavalier en aluminium pour pied banquette + 2 vis  
cut/slim caballete de aluminio para pata bancada + n.2 tornillos

code	finishing	q.kit	q.pack	a	b	kg.x1	vol.x1
111704-222	● aluminium/aluminio	x1	10	60	95	0,40	mc. 0.0012

05 slim-pied en aluminium pour banquette + 2 pieds  
slim-pata de aluminio para bancada + n.2 pies

code	finishing	q.kit	q.pack	a	b	kg.x1	vol.x1
111704-226	● aluminium/aluminio	x2	5	610	350	1,20	mc. 0.014

06 cut-pied en aluminium pour banquette + 2 pieds  
cut-pata de aluminio para bancada + n.2 pies

code	finishing	q.kit	q.pack	a	b	kg.x1	vol.x1
111704-224	● aluminium/aluminio	x2	5	610	350	2,55	mc. 0.014

07 embout couvre-tête rectangulaire 80x40 noir  
tapon embellecedor rectangular 80 x 40 negro

code	finishing	q.kit
134103-001	● noir/negro	x2

08 got(03) poutre pour banquette 80x40  
got(03) viga para bancada 80x40

code	finishing	q.kit	q.pack	a	b	c	kg.x1	vol.x1	
110703-190	● noir/negro	2 places/2 asientos	x1	1	1160	80	40	3,20	mc. 0.0045
110704-090	● gris/gris	2 places/2 asientos	x1	1	1160	80	40	3,20	mc. 0.0045
110703-191	● noir/negro	3 places/3 asientos	x1	1	1710	80	40	4,71	mc. 0.005
110704-091	● gris/gris	3 places/3 asientos	x1	1	1710	80	40	4,71	mc. 0.005
110703-192	● noir/negro	4 places/4 asientos	x1	1	2260	80	40	6,22	mc. 0.0085
110704-092	● gris/gris	4 places/4 asientos	x1	1	2260	80	40	6,22	mc. 0.0085
110703-193	● noir/negro	5 places/5 asientos	x1	1	2800	80	40	7,72	mc. 0.01
110704-193	● gris/gris	5 places/5 asientos	x1	1	2800	80	40	7,72	mc. 0.01

09 gocv-cavalier pour dessous poutre  
gocv-caballete bajo viga

code	finishing	q.kit	q.pack	a	b	kg.x1	vol.x1
110703-007	● noir/negro	x1	50	55	65	0,60	mc. 0.0005
110704-016	● gris/gris	x1	50	55	65	0,60	mc. 0.0005

10 pack vis m8x12 tête cylindrique hexagonale encaissée brunie noire  
paquete de tornillos m8x12 cabeza cilindrica hexagonal embutida bruniado negro

code	finishing	q.kit	q.pack
117003-070	● noir/negro	x4	200

11 cut/slim-cavalier en aluminium pour accoudoir banquette  
cut/slim caballete de aluminio para brazo bancada

code	finishing	q.kit	q.pack	a	b	kg.x1	vol.x1
111704-221	● aluminium/aluminio	x1	10	58	95	0,32	mc. 0.0012

for the bench components, see page 249

# nexus

## bench leg options

• optional

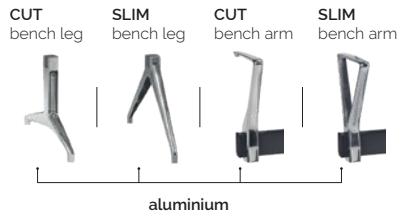
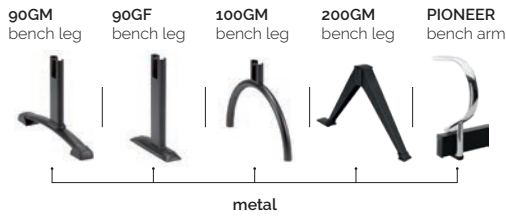
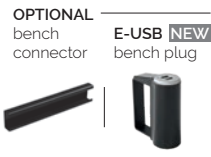

## bench sizes

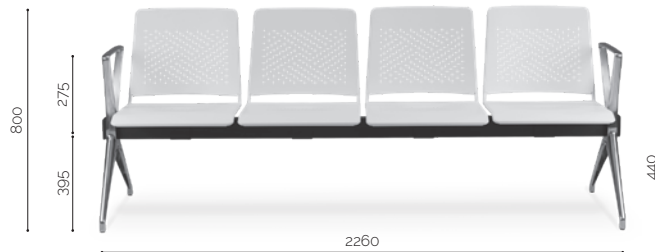
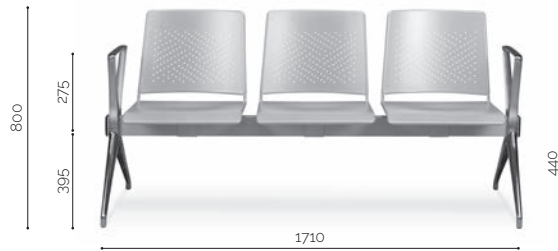
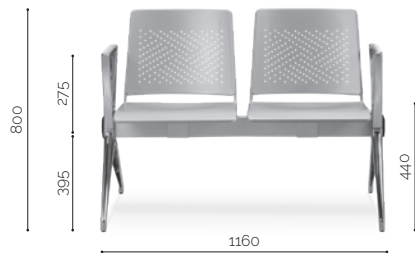

# nexus

## bench

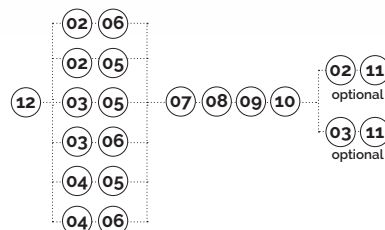
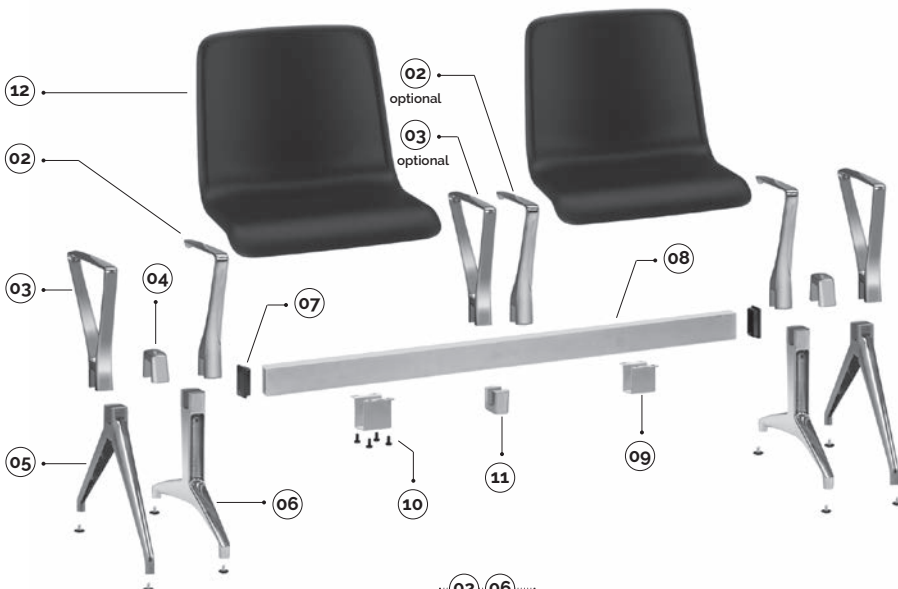

Proposée dans différentes couleurs mono/bi-couleur en lots de 100 pièces

12

Disponible en différentes couleurs mono/bi-couleur para lotes de 100 unidades

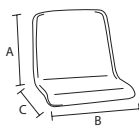

12



04

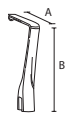

03

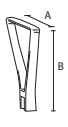

05

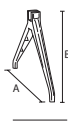

06

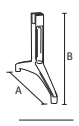

07

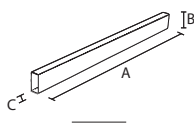

08

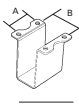

09

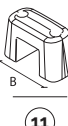

11

12 nexus-coque en polyurethane souple freeform advanced  
nexus-carcasa de poliuretano blando freeform advanced

code	finishing	q.kit	q.pack	a	b	c	kg.x1	vol.x1
133903-061	● noir/negro	x1		410	485	430	7,60	mc. 0.09

02 cut-accoudoir en aluminium pour banquette + 2 vis  
cut-brazo de aluminio para bancada + n.2 tornillos

code	finishing	q.kit	q.pack	a	b	kg.x1	vol.x1
111704-223	● aluminium/aluminio	x1	10	300	305	1,40	mc. 0.0011

03 slim-accoudoir en aluminium pour banquette + 2 vis  
slim-brazo de aluminio para bancada + n.2 tornillos

code	finishing	q.kit	q.pack	a	b	kg.x1	vol.x1
111704-225	● aluminium/aluminio	x1	10	325	305	1,40	mc. 0.0011

04 cut/slim-caballote en aluminium pour pied banquette + 2 vis  
cut/slim caballote de aluminio para pata bancada + n.2 tornillos

code	finishing	q.kit	q.pack	a	b	kg.x1	vol.x1
111704-222	● aluminium/aluminio	x1	10	60	95	0,40	mc. 0.0012

05 slim-pata en aluminium pour banquette + 2 pieds  
slim-pata de aluminio para bancada + n.2 pies

code	finishing	q.kit	q.pack	a	b	kg.x1	vol.x1
111704-226	● aluminium/aluminio	x2	5	610	350	1,20	mc. 0.014

06 cut-pied en aluminium pour banquette + 2 pieds  
cut-pata de aluminio para bancada + n.2 pies

code	finishing	q.kit	q.pack	a	b	kg.x1	vol.x1
111704-224	● aluminium/aluminio	x2	5	610	350	2,55	mc. 0.014

07 embout couvre-tête rectangulaire 80x40 noir  
tapón embellecedor rectangular 80 x 40 negro

code	finishing	q.kit
134103-001	● noir/negro	x2

08 90°(03) poutre pour banquette 80x40  
90°(03) viga para bancada 80x40

code	finishing	places/asientos	q.kit	q.pack	a	b	c	kg.x1	vol.x1
110703-190	● noir/negro	2 places/2 asientos	x1	1	1160	80	40	3,20	mc. 0.0045
110704-090	● gris/gris	2 places/2 asientos	x1	1	1160	80	40	3,20	mc. 0.0045
110703-191	● noir/negro	3 places/3 asientos	x1	1	1710	80	40	4,71	mc. 0.005
110704-091	● gris/gris	3 places/3 asientos	x1	1	1710	80	40	4,71	mc. 0.005
110703-192	● noir/negro	4 places/4 asientos	x1	1	2260	80	40	6,22	mc. 0.0085
110704-092	● gris/gris	4 places/4 asientos	x1	1	2260	80	40	6,22	mc. 0.0085
110703-193	● noir/negro	5 places/5 asientos	x1	1	2800	80	40	7,72	mc. 0.01
110704-193	● gris/gris	5 places/5 asientos	x1	1	2800	80	40	7,72	mc. 0.01

09 90°c-cavalier pour dessous poutre  
90°c-caballote bajo viga

code	finishing	q.kit	q.pack	a	b	kg.x1	vol.x1
110703-007	● noir/negro	x1	50	55	65	0,60	mc. 0.0005
110704-016	● gris/gris	x1	50	55	65	0,60	mc. 0.0005

10 pack vis m8x12 tête cylindrique hexagonale encaissée brunie noire  
paquete de tornillos m8x12 cabeza cilíndrica hexagonal embutida bruñida negro

code	finishing	q.kit	q.pack
117003-070	● noir/negro	x4	200

11 cut/slim-cavalier en aluminium pour accoudoir banquette  
cut/slim caballote de aluminio para brazo bancada

code	finishing	q.kit	q.pack	a	b	kg.x1	vol.x1
111704-221	● aluminium/aluminio	x1	10	58	95	0,32	mc. 0.0012

for the bench components, see page 249





# nexus

4-legs

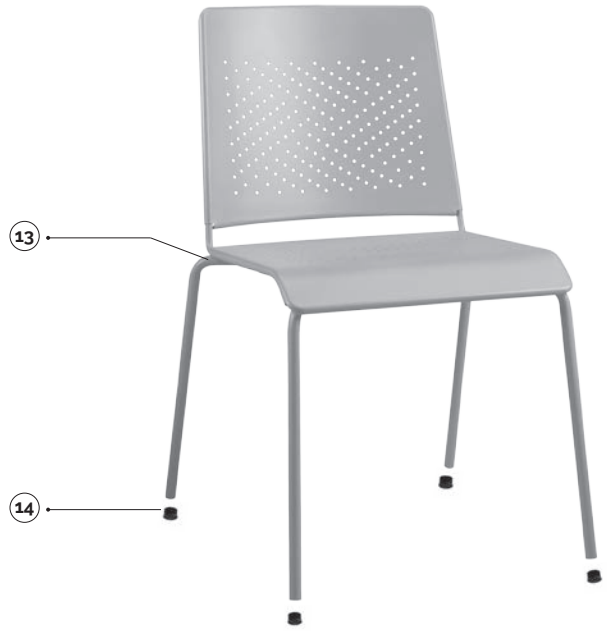

Corten ● \*Une caractéristique spécifique du Corten est la variabilité dans la tonalité de la finition.  
\* Una característica particular del Corten es la variabilidad en la tonalidad del acabado.

13 ..... 14

main component sizes

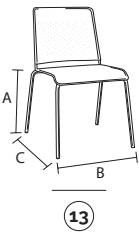

13 nexus-châssis 4 pieds avec coque en tôle  
nexus-estructura 4 patas con carcasa de chapa

code	finishing	q.kit	q.pack	a	b	c	kg.x1	vol.x1
112603-070	● noir/negro	x1	50	450	530	540	9,80	mc. 0,04
112604-070	● gris/gris	x1	50	450	530	540	9,80	mc. 0,04
112605-070	○ blanc/blanco ral9010	x1	50	450	530	540	9,80	mc. 0,04
112607-070	● corten*	x1	50	450	530	540	9,80	mc. 0,04

14 embout à ailettes rond d.18 noir  
tacos redondos con aletas d.18 negro

code	finishing	q.kit	q.pack
137003-072	● noir/negro	x4	200



nexus-chariot porte-chaises noir avec accessoires  
nexus-carro para sillas con accesorios negro

code	finishing	q.kit
110803-342	● noir/negro	x1

# nexus

slide

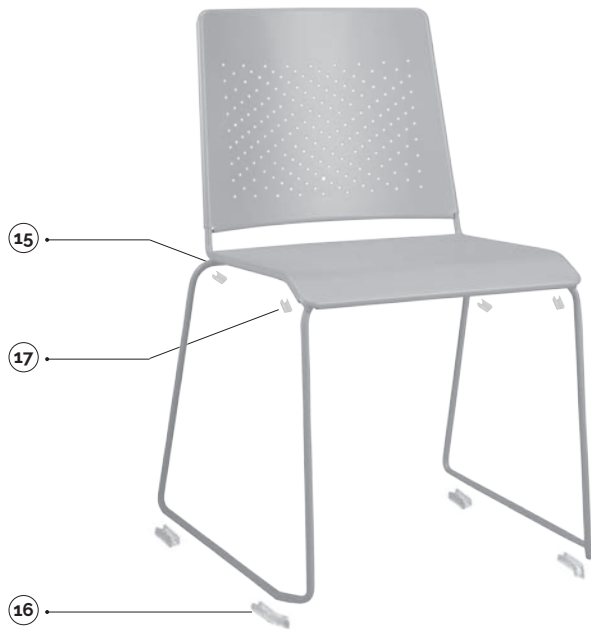

Corten  
 • \*Une caractéristique spécifique du Corten est la variabilité dans la tonalité de la finition.  
 \* Una característica particular del Corten es las variabilidad en la tonalidad del acabado.

15 16 17

main component sizes

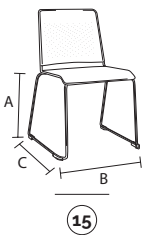

15

15 **nexus-châssis coulissant tige avec coque en tôle**  
 nexus-estructura patin de varilla con carcasa de chapa

code	finishing	q.kit	q.pack	a	b	c	kg.x1	vol.x1
113403-010	● noir/negro	x1	50	450	520	565	8,20	mc. 0,04
113404-010	● gris/gris	x1	50	450	520	565	8,20	mc. 0,04
113405-010	○ blanc/blanco	x1	50	450	520	565	8,20	mc. 0,04
113407-010	● corten*	x1	50	450	520	565	8,20	mc. 0,04

16 **btf-kit pieds**  
 btf-kit pies

code	finishing	q.kit	q.pack	kg.x1
134306-001	○ neutre/neutro	x1	100	0,05

17 **pack de bases a pince anti-rotation pour tige couleur neutre**  
 paquete de bases con pinza antirotacion para varilla de color neutro

code	finishing	q.kit	q.pack
137006-070	○ neutre/neutro	x4	200

optionals



16



17

