

# bench components

components

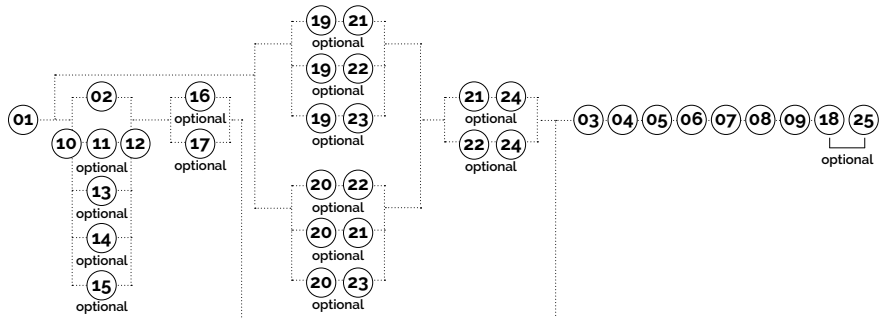

designed by:  
ivano dalla val

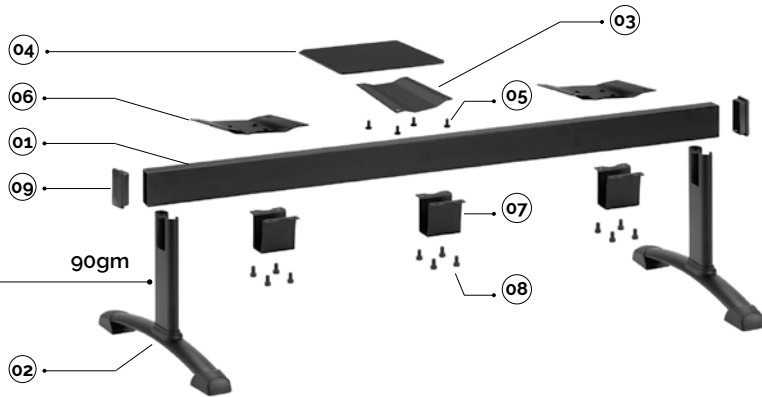

main component sizes

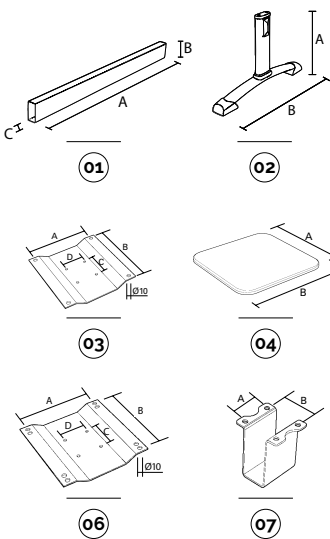

## 01 90t-poutre pour banquette 90t-viga para bancada

code	finishing		q.kit	q.pack	a	b	c	kg.x1	vol.x1
110703-020	● noir/negro	2 places/2 asientos	x1	1	1000	80	40	2,80	mc. 0,003
110704-043	● gris/gris	2 places/2 asientos	x1	1	1000	80	40	2,80	mc. 0,003
110703-021	● noir/negro	3 places/3 asientos	x1	1	1500	80	40	4,20	mc. 0,0045
110704-044	● gris/gris	3 places/3 asientos	x1	1	1500	80	40	4,20	mc. 0,0045
110703-022	● noir/negro	4 places/4 asientos	x1	1	2000	80	40	5,60	mc. 0,006
110704-045	● gris/gris	4 places/4 asientos	x1	1	2000	80	40	5,60	mc. 0,006
110703-023	● noir/negro	5 places/5 asientos	x1	1	2500	80	40	7,00	mc. 0,0085
110704-046	● gris/gris	5 places/5 asientos	x1	1	2500	80	40	7,00	mc. 0,0085

## 02 90ap-pied mobile pour banquette avec accessoires 90ap-pata móvil para bancada con accesorios

code	finishing		q.kit	q.pack	a	b	kg.x1	vol.x1
110703-005	● noir/negro		x2	2	380	600	2,70	mc. 0,012
110704-001	● gris/gris		x2	2	380	600	2,70	mc. 0,012
110710-001	● chromé/cromado		x2	2	380	600	2,70	mc. 0,012

## 03 90ap-raccordement porte plateau 90ap-enganche soporte mesa

code	finishing		q.kit	q.pack	a	b	c	d	kg.x1	vol.x1
110703-014	● noir/negro		x1	25	170	200	65	55	1,00	mc. 0,0002
110704-019	● gris/gris		x1	25	170	200	65	55	1,00	mc. 0,0002

## 04 90tn-plateau de table pour banquette 90tn-mesa para bancada

code	finishing		q.kit	q.pack	a	b	kg.x1	vol.x1
120303-001	● noir/negro		x1	10	400	400	2,20	mc. 0,002

## 05 vis tc + m6x12 brunie noire tornillo tc + m6x12 bruñido negro

code	finishing		q.kit
117703-177	● noir/negro		x4

## 06 92p-plaquette pour banquette vernie 92p-placa para bancada pintada

code	finishing		q.kit	q.pack	a	b	c	d	kg.x1	vol.x1
110703-013	● noir/negro		x1	25	153	200	65	55	0,85	mc. 0,0008

## 07 90cv-cavalier pour dessous poutre 90cv-caballette bajo viga

code	finishing		q.kit	q.pack	a	b	kg.x1	vol.x1
110703-007	● noir/negro		x1	50	55	65	0,60	mc. 0,0005
110704-015	● gris/gris		x1	50	55	65	0,60	mc. 0,0005

## 08 pack vis m8x12 tête cylindrique hexagonale encaissée brunie noire paquete de tornillos m8x12 cabeza cilíndrica hexagonal embutida bruñido negro

code	finishing		q.kit	q.pack
117003-070	● noir/negro		x4	200

## 09 embout couvre-tête rectangulaire 80x40 noir tapón embellecedor rectangular 80 x 40 negro

code	finishing		q.kit
134103-001	● noir/negro		x2

# bench leg & arm options

## components

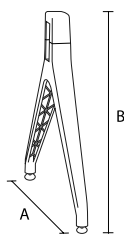

- 10** jim-pied en plastique noir  
jim-pata de plástico negra



certification / Jim



EN16139

code	finishing	q.kit	q.pack	a	b	kg.x1	vol.x1
130703-004	● noir/negro	x2	10	630	425	0,95	mc. 0,0102

- 11** jim-cavalier d'assemblage pour pied noir en plastique  
jim-caballete para fijación pata en plástico negro

code	finishing	q.kit	q.pack	kg.x1	vol.x1
130703-005	● noir/negro	x2	10	0,16	mc. 0,0005

- 12** jim-kit accessoires pour 10 pieds  
jim-kit de accesorios para 10 patas

code	finishing	q.kit	q.pack	kg.x1	vol.x1
130703-007	● noir/negro	x0,2	1	0,15	mc. 0,0004

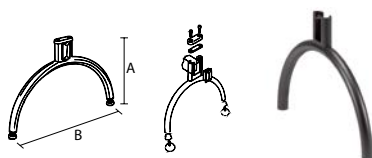

- 13** 100gm-pied mobile pour banquette avec accessoires  
100gm-pata móvil para bancada con accesorios

code	finishing	q.kit	q.pack	a	b	kg.x1	vol.x1
110703-008	● noir/negro	x2	2	380	600	2,10	mc. 0,012
110704-006	● gris/gris	x2	2	380	600	2,10	mc. 0,012
110710-005	● chromé/cromado	x2	2	380	600	2,10	mc. 0,012

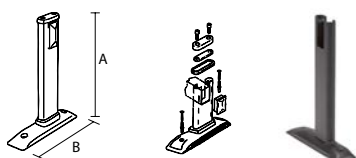

- 14** 90gf-pied fixe pour banquette avec accessoires  
90gf-pata fija para bancada con accesorios

code	finishing	q.kit	q.pack	a	b	kg.x1	vol.x1
110703-030	● noir/negro	x2	2	380	310	1,90	mc. 0,012
110704-012	● gris/gris	x2	2	380	310	1,90	mc. 0,012

designed by:  
stefano bettio



- 15** 200gm-pied mobile pour banquette avec accessoires  
200gm-pata móvil para bancada con accesorios

code	finishing	q.kit	q.pack	a	b	kg.x1	vol.x1
110703-110	● noir/negro	x2	4	380	600	2,60	mc. 0,005
110704-110	● gris/gris	x2	4	380	600	2,60	mc. 0,005
110710-110	● chromé/cromado	x2	4	380	600	2,60	mc. 0,005

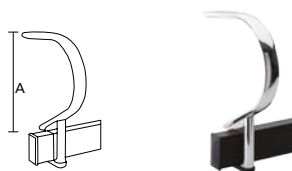

- 16** pioneer-accoudoir elliptique 40x20 pour banquette avec accessoires  
pioneer-brazo elíptico 40x20 para bancada con accesorios

code	finishing	q.kit	q.pack	a	kg.x1	vol.x1
111703-015	● noir/negro	x1	5	260	1,10	mc. 0,005
111704-015	● gris/gris	x1	5	260	1,10	mc. 0,005
111710-015	● chromé/cromado	x1	5	260	1,10	mc. 0,005

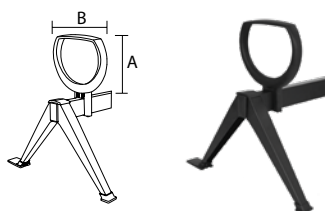

- 17** apoll-accoudoir en plastique + cavalier pour banquette  
apoll-brazo de plástico + caballete para bancada

code	finishing	q.kit	q.pack	a	b	kg.x1	vol.x1
131703-065	● noir/negro	x1	10	275	300	0,90	mc. 0,008

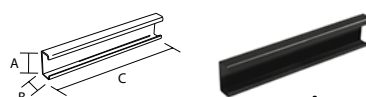

- 18** liaison poutre banquette  
empalme viga bancada

code	finishing	q.kit	q.pack	a	b	b	kg.x1
110703-025	● noir/negro	x1	10	75	36	400	1,42

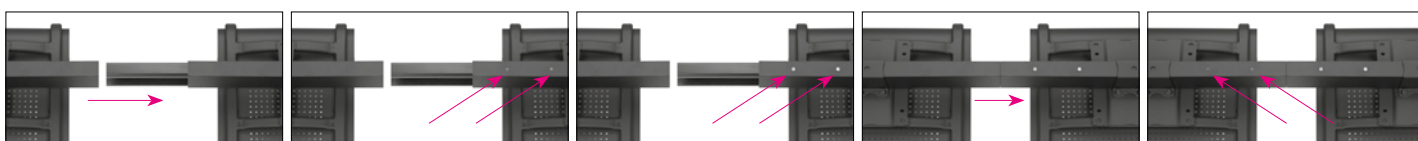

01

02

03

04

05

# bench leg & arm options

components / cut & slim options



designed by:  
**alessandro crosera**

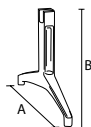

**19** cut-pied en aluminium pour banquette + 2 pieds  
cut-pata de aluminio para bancada + n. 2 pies

code	finishing	q.kit	q.pack	a	b	kg.x1	vol.x1
111704-224	⊖ aluminium/aluminio	x2	5	610	350	2,75	mc. 0.0132

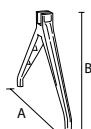

**20** slim-pied en aluminium pour banquette + 2 pieds  
slim-pata de aluminio para bancada + n. 2 pies

code	finishing	q.kit	q.pack	a	b	kg.x1	vol.x1
111704-226	⊖ aluminium/aluminio	x2	5	610	350	1,3125	mc. 0.0102



**21** cut-accoudoir en aluminium pour banquette + 2 vis  
cut-brazo de aluminio para bancada + n. 2 tornillos

code	finishing	q.kit	q.pack	a	b	kg.x1	vol.x1
111704-223	⊖ aluminium/aluminio	x1	10	300	305	1,6065	mc. 0.0028



**22** slim-accoudoir en aluminium pour banquette + 2 vis  
slim-brazo de aluminio para bancada + n. 2 tornillos

code	finishing	q.kit	q.pack	a	b	kg.x1	vol.x1
111704-225	⊖ aluminium/aluminio	x1	10	325	305	1,464	mc. 0.0049



**23** cut/slim-cavalier en aluminium pour pied banquette + 2 vis  
cut/slim caballete de aluminio para pata bancada + n. 2 tornillos

code	finishing	q.kit	q.pack	a	b	kg.x1	vol.x1
111704-222	⊖ aluminium/aluminio	x2	10	60	95	0,30	mc. 0.0005

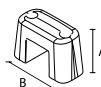

**24** cut/slim-cavalier en aluminium pour accoudoir banquette  
cut/slim caballete de aluminio para brazo bancada

code	finishing	q.kit	q.pack	a	b	kg.x1	vol.x1
111704-221	⊖ aluminium/aluminio	x1	10	58	95	0,38	mc. 0.0005

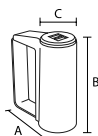

**25** e:usb-charger pour banquette  
e:usb-cargador para bancada

code	finishing	q.kit	q.pack	a	b	c	kg.x1	vol.x1
130703-002	● noir/negro	x1	5	85	100	38	0,28	mc. 0.0009

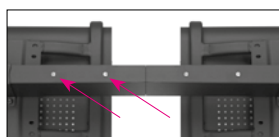

06

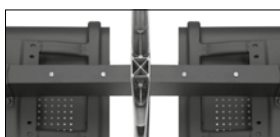

07

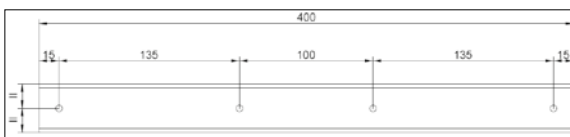

→ trame de perçage conseillée, côté bas poutre  
perforación aconsejada, lado inferior viga