



Certified

La serie 90 è la sedia da grandi numeri e caratterizzata dal classico disegno, ma prodotta con la riconosciuta qualità del marchio Metalmeccanica Alba. Un ampio assortimento di telai e componenti completano un'offerta di un prodotto essenziale e versatile, capace di soddisfare ogni esigenza negli ambiti più diversi.

The series 90 is a high volume chair, characterized by a classic design but produced with the recognized quality of the Metalmeccanica Alba brand. A wide assortment of frames and components complete the offer of an essential and versatile product, designed to meet every need in the most varied locations.



EN 1728

albacomponents



90

■ . co-branding project



SLIDE



4 LEGS



SWIVEL



SLIDE



4 LEGS



SLIDE

CERTIFIED BY
CATAS



BENCH

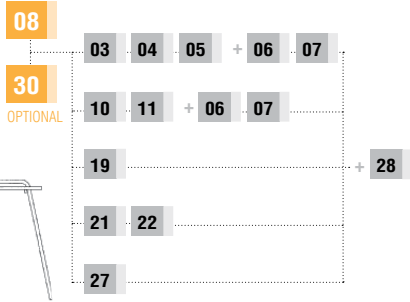
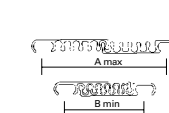
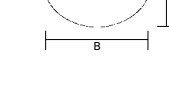
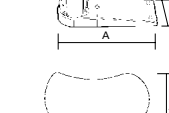
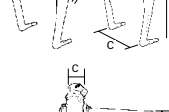
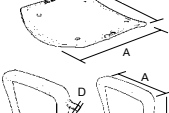
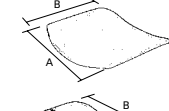
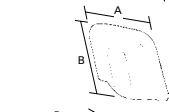
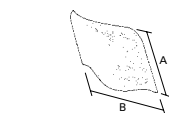
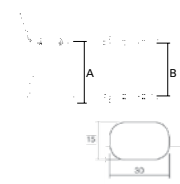

08 92-TELAIO PER SEDIA IN TUBO OVALE 30x15 CON TAPPI LATERALI E SOTTOPIEDE MONTATI
92-CHAIR FRAME IN 30X15 OVAL TUBE WITH SIDE AND FOOT CAPS MOUNTED

CODICE/CODE	FINITURA/FINISHING	ATT.BRACC./ARM ATTACH	Q.KIT	Q.MIN/PACK	A	B	KG.x1/WT.x1	VOL.x1/UNIT VOL.
112003-005	■ NERO/BLACK	12	x1	160	450	425	3,00	mc. 0,021
112003-004	■ NERO/BLACK	14	x1	160	450	425	3,00	mc. 0,021
112004-000	■ GRIGIO/GREY	12	x1	160	450	425	3,00	mc. 0,021
112004-002	■ GRIGIO/GREY	14	x1	160	450	425	3,00	mc. 0,021
112010-008	■ CROMATO/CHROME	12	x1	160	450	425	3,00	mc. 0,021
112010-005	■ CROMATO/CHROME	14	x1	160	450	425	3,00	mc. 0,021

30 92-TELAIO PER SEDIA IN TUBO OVALE 30x15 CON AGGANCIAMENTO LATERALE IN METALLO SALDATO, CON TAPPI LATERALI E SOTTOPIEDE MONTATI
92-CHAIR FRAME IN 30X15 OVAL TUBE WITH METAL LATERAL HOOK WELDED, SIDE AND FOOT CAPS MOUNTED

CODICE/CODE	FINITURA/FINISHING	ATT.BRACC./ARM ATTACH	Q.KIT	Q.MIN/PACK	A	B	KG.x1/WT.x1	VOL.x1/UNIT VOL.
112003-016	■ NERO/BLACK	12	x1	160	450	425	3,00	mc. 0,021
112003-015	■ NERO/BLACK	14	x1	160	450	425	3,00	mc. 0,021
112004-007	■ GRIGIO/GREY	12	x1	160	450	425	3,00	mc. 0,021
112004-008	■ GRIGIO/GREY	14	x1	160	450	425	3,00	mc. 0,021
112010-016	■ CROMATO/CHROME	12	x1	160	450	425	3,00	mc. 0,021
112010-015	■ CROMATO/CHROME	14	x1	160	450	425	3,00	mc. 0,021

10 90SHI-SCHIENALE INTERNO IN PLASTICA
90SHI-PLASTIC INTERNAL BACKREST

CODICE/CODE	FINITURA/FINISHING	Q.KIT	Q.MIN/PACK	A	B	KG.x1/WT.x1	VOL.x1/UNIT VOL.
132103-002	■ NERO/BLACK	x1	40	330	470	0,60	mc. 0,004

11 90SHE-COPRISCHIENALE ESTERNO IN PLASTICA
90SHE-EXTERNAL PLASTIC BACKREST COVER

CODICE/CODE	FINITURA/FINISHING	Q.KIT	Q.MIN/PACK	A	B	KG.x1/WT.x1	VOL.x1/UNIT VOL.
132103-001	■ NERO/BLACK	x1	30	475	335	0,40	mc. 0,004

06 90SDI-SEDILE INTERNO IN PLASTICA
90SDI-INNER PLASTIC FOR METAL FRAME

CODICE/CODE	FINITURA/FINISHING	Q.KIT	Q.MIN/PACK	A	B	KG.x1/WT.x1	VOL.x1/UNIT VOL.
132203-002	■ NERO/BLACK	x1	30	460	400	0,80	mc. 0,004

07 90SDE-SOTTOSEDILE ESTERNO PLASTICA
90SDE-OUTER PLASTIC SEAT FOR METAL FRAME

CODICE/CODE	FINITURA/FINISHING	Q.KIT	Q.MIN/PACK	A	B	KG.x1/WT.x1	VOL.x1/UNIT VOL.
132203-001	■ NERO/BLACK	x1	80	410	465	0,40	mc. 0,003

12 90B-BRACCIOLINO IN NYLON 90BP-BRACCIOLINO IN NYLON CON AGGANCIAMENTO PORTA TAVOLETTA
90B-NYLON ARMREST 90BP-WITH WRITING TABLET HOOK

CODICE/CODE	FINITURA/FINISHING	ATT.BRACC./ARM ATTACH	Q.KIT	Q.MIN/PACK	A	B	C	D	KG.x1/WT.x1	VOL.x1/UNIT VOL.
90BP14	■ NERO/BLACK	14*	x1	20	290	250	190	15x15	0,80	mc. 0,0026
90B14	■ NERO/BLACK	14	x2	20	290	250	190		0,80	mc. 0,0026
90BP	■ NERO/BLACK	12*	x1	20	290	250	190	15x15	0,80	mc. 0,0026
90B	■ NERO/BLACK	12	x2	20	290	250	190		0,80	mc. 0,0026

* GANCIO TAV./HOOK TABLE

13 SPT2-SNODO PER TAVOLETTA IN TERMOPLASTICA
SPT2-THERMOPLASTIC WRITING TABLET ARTICULATION

CODICE/CODE	FINITURA/FINISHING	Q.KIT	Q.MIN/PACK	A	B	C	KG.x1/WT.x1	VOL.x1/UNIT VOL.
134003-039	■ NERO/BLACK	x1	20	180	66	15x15	0,35	mc. 0,0006

14 BEAN-TAVOLETTA IN TERMOPLASTICO SPESSORE 16 mm
BEAN-16MM THICK THERMOPLASTIC WRITING TABLET

CODICE/CODE	FINITURA/FINISHING	Q.KIT	Q.MIN/PACK	A	B	KG.x1/WT.x1	VOL.x1/UNIT VOL.
134003-044	■ NERO/BLACK	x1	20	235	370	0,40	mc. 0,002

17 92C-CESTELLO PORTARIVISTE
92C-MAGAZINE RACK

CODICE/CODE	FINITURA/FINISHING	Q.KIT	Q.MIN/PACK	KG.x1/WT.x1	VOL.x1/UNIT VOL.
113403-001	■ NERO/BLACK	x1	25	0,975	mc. 0,03
113410-020	■ CROMATO/CHROME	x1	25	0,975	mc. 0,03

18 COPPIA PINZE REGOLABILI PER TUBO OVALE 15X30 PP
CLIPS FOR OVAL TUBE 15X30 PP

CODICE/CODE	FINITURA/FINISHING	Q.KIT	Q.MIN/PACK	A	B
134003-002	■ NERO/BLACK	x1	200	214	134

28 VITE TESTA SVASATA CROCE M6x18 BRUNITA NERA-FISSAGGIO SEDILE/ SCHIENALE FAGGIO
M6X18 BLACK BURNISHED FLARED PHILIPS SCREW-BEECH SEAT/BACKREST FIXING

CODICE/CODE	FINITURA/FINISHING	Q.KIT
117703-195	■ NERO/BLACK	x4

OPTIONAL 29

AGGANCIAMENTO LATERALE MASCHIO-FEMMINA IN PLASTICA CON 2 VITI
PLASTIC LATERAL HOOK MALE-FEMALE WITH 2 SCREWS
134003-132 ■ NERO/BLACK



4 LEGS OPTIONS:

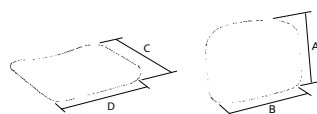
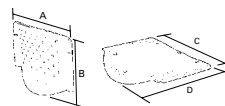
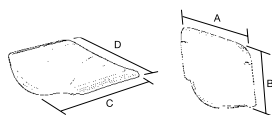
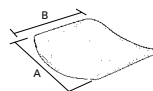
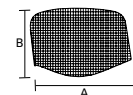
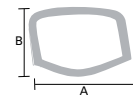
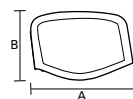

03	ISONET-TELAIO SCHIENALE IN PLASTICA CON VITI PER RETE		ISONET-OUTER FRAME WITH SCREWS FOR NET		Q. KIT	Q. MIN/PACK	A	B	KG. x1/WT.x1	VOL. x1/UNIT VOL.		
132103-003	FINITURA/FINISHING	■ NERO/BLACK	x1	25	470	345			0,42	mc. 0,006		
04	ISONET-CORNICE SCHIENALE IN PLASTICA PER RETE		ISONET-OPEN FRAME FOR ISONET MODEL		Q. KIT	Q. MIN/PACK	A	B	KG. x1/WT.x1	VOL. x1/UNIT VOL.		
132103-004	FINITURA/FINISHING	■ NERO/BLACK	x1	25	470	345			0,31	mc. 0,004		
05	ISONET-RETE PER SCHIENALE		ISONET-NET FOR BACK		Q. KIT	Q. MIN/PACK	A	B	KG. x1/WT.x1	VOL. x1/UNIT VOL.		
132105-500	FINITURA/FINISHING	□ BIANCO/WHITE	x1	25	550	400			0,14	mc. 0,0057		
132103-500	FINITURA/FINISHING	■ NERO/BLACK	x1	25	550	400			0,14	mc. 0,0057		
132102-500	FINITURA/FINISHING	■ ROSSO/RED	x1	25	550	400			0,14	mc. 0,0057		
06	90SDI-SEDILE INTERNO IN PLASTICA		90SDI-INNER PLASTIC FOR METAL FRAME		Q. KIT	Q. MIN/PACK	A	B	KG. x1/WT.x1	VOL. x1/UNIT VOL.		
132203-002	FINITURA/FINISHING	■ NERO/BLACK	x1	30	460	400			0,80	mc. 0,004		
07	90SDE-SOTTOSEDILE ESTERNO PLASTICA		90SDE-OUTER PLASTIC SEAT FOR METAL FRAME		Q. KIT	Q. MIN/PACK	A	B	KG. x1/WT.x1	VOL. x1/UNIT VOL.		
132203-001	FINITURA/FINISHING	■ NERO/BLACK	x1	80	410	465			0,40	mc. 0,003		
19	NOVX-SEDILE E SCHIENALE IN PLASTICA DISPONIBILI PER TELAIO IN TUBO OVALE E IN TUBO ELLITTICO		NOVX-PLASTIC SEAT AND BACKREST AVAILABLE FOR OVAL OR ELLIPTIC TUBE FRAME		Q. KIT	Q. MIN/PACK	A	B	C	D	KG. x1/WT.x1	VOL. x1/UNIT VOL.
134002-001	FINITURA/FINISHING	■ ROSSO/RED	RAL3002	x1	20	470	315	460	400	1,21	mc. 0,008	
134003-119	FINITURA/FINISHING	■ NERO/BLACK	RAL9005	x1	20	470	315	460	400	1,21	mc. 0,008	
134015-003	FINITURA/FINISHING	■ BLU/BLUE	RAL5002	x1	20	470	315	460	400	1,21	mc. 0,008	
21	PRISMA-SCHIENALE E SEDILE IN PLASTICA DISPONIBILI PER TELAIO IN TUBO OVALE E IN TUBO ELLITTICO		PRISMA-PLASTIC BACKREST AND SEAT AVAILABLE FOR OVAL OR ELLIPTIC TUBE FRAME		Q. KIT	Q. MIN/PACK	A	B	C	D	KG. x1/WT.x1	VOL. x1/UNIT VOL.
134003-110	FINITURA/FINISHING	■ NERO/BLACK		x1	10	470	330	460	430	1,60	mc. 0,016	
22	PRISMA-PANNELLO SEDILE DA TAPPEZZARE		PRISMA-SEAT PANEL TO UPHOLSTER		Q. KIT	Q. MIN/PACK	A	B	KG. x1/WT.x1	VOL. x1/UNIT VOL.		
132203-010	FINITURA/FINISHING	■ NERO/BLACK		x1	20	400	400		0,40	mc. 0,004		
27	90SHSDLF-SCHIENALE + SEDILE MULTISTRATO VERNICIATO FAGGIO + 4 TESTINE		90SHSDLF-BACKREST + SEAT IN PAINTED PLANED BEECH PLYWOOD		Q. KIT	Q. MIN/PACK	A	B	C	D	KG. x1/WT.x1	VOL. x1/UNIT VOL.
124007-000	FINITURA/FINISHING	■ FAGGIO/BEECH-WOOD		x1	10	330	465	400	465	2,70	mc. 0,07	
28	VITE TESTA SVASATA CROCE M6x18 BRUNITA NERA-FISSAGGIO SEDILE/ SCHIENALE FAGGIO		M6X18 BLACK BURNISHED FLARED PHILIPS SCREW-BEECH SEAT/BACKREST FIXING		Q. KIT							
117703-195	FINITURA/FINISHING	■ NERO/BLACK		x4								

OPTIONAL

TAVOLETTA TLT
TLT TABLET



VEDI/SEE PAG. 321

TAVOLETTA TLT2
TLT2 TABLET



VEDI/SEE PAG. 321

TAVOLETTA TLT3
TLT3 TABLET



VEDI/SEE PAG. 321

TAVOLETTA BEAN
BEAN TABLET



VEDI/SEE PAG. 321

TAVOLETTA TL01
TL01 TABLET



VEDI/SEE PAG. 321

SNODO TAVOLETTA SPT2
SPT2 MECHANISM TABLET



VEDI/SEE PAG. 320

SNODO ANTIPANICO
MECHANISM ANTIPANIC



VEDI/SEE PAG. 320

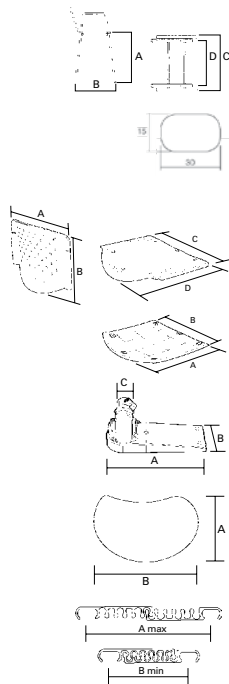

20 94-TELAIO PER SEDIA IN TUBO OVALE 30x15 CON BRACCIOLI CON TAPPI LATERALI E SOTTOPIEDE MONTATI
94-CHAIR FRAME IN 30X15 OVAL TUBE WITH ARMRESTS, SIDE AND FOOT CAPS MOUNTED

CODICE/CODE	FINITURA/FINISHING	Q.KIT	Q.MIN/PACK	A	B	C	D	KG.x1/WT.x1	VOL.x1/UNIT VOL.
112003-020	■ NERO/BLACK	x1	80	450	470	545	425	3,80	mc. 0,042
112004-021	■ GRIGIO/GREY	x1	80	450	470	545	425	3,80	mc. 0,042
112010-040	■ CROMATO/CHROME	x1	80	450	470	545	425	3,80	mc. 0,042
* 112003-022	■ NERO/BLACK	x1	80	450	470	545	425	3,80	mc. 0,042
* 112004-022	■ GRIGIO/GREY	x1	80	450	470	545	425	3,80	mc. 0,042
* 112010-043	■ CROMATO/CHROME	x1	80	450	470	545	425	3,80	mc. 0,042

* GANCIO TAV./HOOK TABLE

21 PRISMA-SCHIENALE E SEDILE IN PLASTICA DISPONIBILI PER TELAIO IN TUBO OVALE E IN TUBO ELLITTICO
PRISMA-PLASTIC BACKREST AND SEAT AVAILABLE FOR OVAL OR ELLIPTIC TUBE FRAME

CODICE/CODE	FINITURA/FINISHING	Q.KIT	Q.MIN/PACK	A	B	C	D	KG.x1/WT.x1	VOL.x1/UNIT VOL.
134003-110	■ NERO/BLACK	x1	10	470	330	460	430	1,60	mc. 0,016

22 PRISMA-PANNELLO SEDILE DA TAPPEZZARE
PRISMA-SEAT PANEL TO UPHOLSTER

CODICE/CODE	FINITURA/FINISHING	Q.KIT	Q.MIN/PACK	A	B	KG.x1/WT.x1	VOL.x1/UNIT VOL.
132203-010	■ NERO/BLACK	x1	20	400	400	0,40	mc. 0,004

13 SPT2-SNODO PER TAVOLETTA IN TERMOPLASTICA
SPT2-THERMOPLASTIC WRITING TABLET ARTICULATION

CODICE/CODE	FINITURA/FINISHING	Q.KIT	Q.MIN/PACK	A	B	C	KG.x1/WT.x1	VOL.x1/UNIT VOL.
134003-039	■ NERO/BLACK	x1	20	180	66	15x15	0,35	mc. 0,0006

14 BEAN-TAVOLETTA IN TERMOPLASTICO SPESSORE 16 mm
BEAN-16MM THICK THERMOPLASTIC WRITING TABLET

CODICE/CODE	FINITURA/FINISHING	Q.KIT	Q.MIN/PACK	A	B	KG.x1/WT.x1	VOL.x1/UNIT VOL.
134003-044	■ NERO/BLACK	x1	20	235	370	0,40	mc. 0,002

18 COPPIA PINZE REGOLABILI PER TUBO OVALE 15X30 PP
CLIPS FOR OVAL TUBE 15X30 PP

CODICE/CODE	FINITURA/FINISHING	Q.KIT	Q.MIN/PACK	A	B
134003-002	■ NERO/BLACK	x1	200	214	134

28 VITE TESTA SVASATA CROCE M6x18 BRUNITA NERA-FISSAGGIO SEDILE/ SCHIENALE FAGGIO
M6X18 BLACK BURNISHED FLARED PHILIPS SCREW-BEECH SEAT/BACKREST FIXING

CODICE/CODE	FINITURA/FINISHING	Q.KIT
117703-195	■ NERO/BLACK	x4

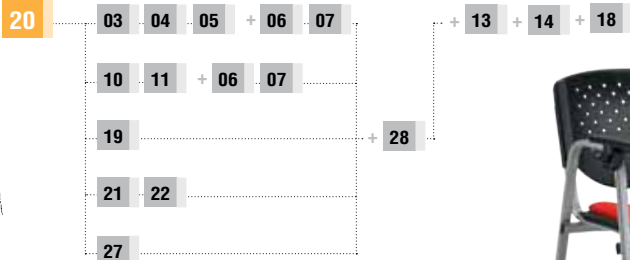

OPTIONAL

TAVOLETTA TLT TLT TABLET	TAVOLETTA TLT2 TLT2 TABLET	TAVOLETTA TLT3 TLT3 TABLET	TAVOLETTA BEAN BEAN TABLET	TAVOLETTA TL01 TL01 TABLET	SNODO TAVOLETTA SPT2 SPT2 MECHANISM TABLET	SNODO ANTIPANICO MECHANISM ANTIPANIC
VEDI/SEE PAG. 327	VEDI/SEE PAG. 327	VEDI/SEE PAG. 327	VEDI/SEE PAG. 327	VEDI/SEE PAG. 327	VEDI/SEE PAG. 326	VEDI/SEE PAG. 326

4 LEGS OPTIONS:

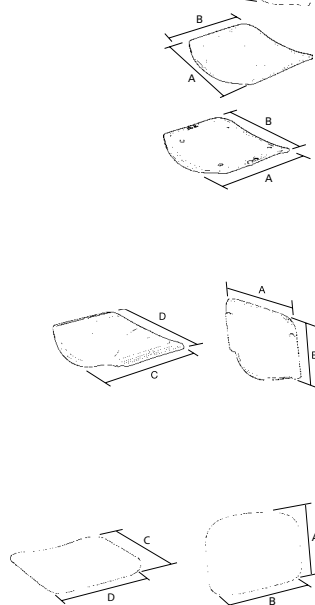
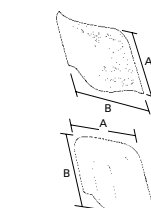
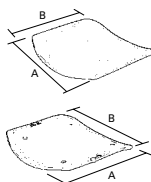
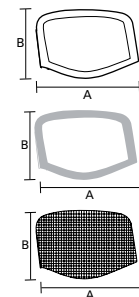

03 ISONET-TELAIO SCHIENALE IN PLASTICA CON VITI PER RETE									
ISONET-OUTER FRAME WITH SCREWS FOR NET									
CODICE/CODE	FINITURA/FINISHING	Q. KIT	Q. MIN/PACK	A	B	KG. x1/WT.x1	VOL. x1/UNIT VOL.		
132103-003	■ NERO/BLACK	x1	25	470	345	0,42	mc. 0,006		

04 ISONET-CORNICE SCHIENALE IN PLASTICA PER RETE									
ISONET-OPEN FRAME FOR ISONET MODEL									
CODICE/CODE	FINITURA/FINISHING	Q. KIT	Q. MIN/PACK	A	B	KG. x1/WT.x1	VOL. x1/UNIT VOL.		
132103-004	■ NERO/BLACK	x1	25	470	345	0,31	mc. 0,004		

05 ISONET-RETE PER SCHIENALE									
ISONET-NET FOR BACK									
CODICE/CODE	FINITURA/FINISHING	Q. KIT	Q. MIN/PACK	A	B	KG. x1/WT.x1	VOL. x1/UNIT VOL.		
132105-500	□ BIANCO/WHITE	x1	25	550	400	0,14	mc. 0,0057		
132103-500	■ NERO/BLACK	x1	25	550	400	0,14	mc. 0,0057		
132102-500	■ ROSSO/RED	x1	25	550	400	0,14	mc. 0,0057		

06 90SDI-SEDILE INTERNO IN PLASTICA									
90SDI-INNER PLASTIC FOR METAL FRAME									
CODICE/CODE	FINITURA/FINISHING	Q. KIT	Q. MIN/PACK	A	B	KG. x1/WT.x1	VOL. x1/UNIT VOL.		
132203-002	■ NERO/BLACK	x1	30	460	400	0,80	mc. 0,004		

07 90SDE-SOTTOSEDILE ESTERNO PLASTICA									
90SDE-OUTER PLASTIC SEAT FOR METAL FRAME									
CODICE/CODE	FINITURA/FINISHING	Q. KIT	Q. MIN/PACK	A	B	KG. x1/WT.x1	VOL. x1/UNIT VOL.		
132203-001	■ NERO/BLACK	x1	80	410	465	0,40	mc. 0,003		

10 90SHI-SCHIENALE INTERNO IN PLASTICA									
90SHI-PLASTIC INTERNAL BACKREST									
CODICE/CODE	FINITURA/FINISHING	Q. KIT	Q. MIN/PACK	A	B	KG. x1/WT.x1	VOL. x1/UNIT VOL.		
132103-002	■ NERO/BLACK	x1	40	330	470	0,60	mc. 0,004		

11 90SHE-COPRISCHIENALE ESTERNO IN PLASTICA									
90SHE-EXTERNAL PLASTIC BACKREST COVER									
CODICE/CODE	FINITURA/FINISHING	Q. KIT	Q. MIN/PACK	A	B	KG. x1/WT.x1	VOL. x1/UNIT VOL.		
132103-001	■ NERO/BLACK	x1	30	475	335	0,40	mc. 0,004		

06 90SDI-SEDILE INTERNO IN PLASTICA									
90SDI-INNER PLASTIC FOR METAL FRAME									
CODICE/CODE	FINITURA/FINISHING	Q. KIT	Q. MIN/PACK	A	B	KG. x1/WT.x1	VOL. x1/UNIT VOL.		
132203-002	■ NERO/BLACK	x1	30	460	400	0,80	mc. 0,004		

07 90SDE-SOTTOSEDILE ESTERNO PLASTICA									
90SDE-OUTER PLASTIC SEAT FOR METAL FRAME									
CODICE/CODE	FINITURA/FINISHING	Q. KIT	Q. MIN/PACK	A	B	KG. x1/WT.x1	VOL. x1/UNIT VOL.		
132203-001	■ NERO/BLACK	x1	80	410	465	0,40	mc. 0,003		

19 NOVX-SEDILE E SCHIENALE IN PLASTICA DISPONIBILI PER TELAIO IN TUBO OVALE E IN TUBO ELLITTICO										
NOVX-PLASTIC SEAT AND BACKREST AVAILABLE FOR OVAL OR ELLIPTIC TUBE FRAME										
CODICE/CODE	FINITURA/FINISHING	Q. KIT	Q. MIN/PACK	A	B	C	D	KG. x1/WT.x1	VOL. x1/UNIT VOL.	
134002-001	■ ROSSO/RED	RAL3002	x1	20	470	315	460	400	1,21	mc. 0,008
134003-119	■ NERO/BLACK	RAL9005	x1	20	470	315	460	400	1,21	mc. 0,008
134015-003	■ BLU/BLUE	RAL5002	x1	20	470	315	460	400	1,21	mc. 0,008

27 90SHSDLF-SCHIENALE + SEDILE MULTISTRATO VERNICIATO FAGGIO + 4 TESTINE										
90SHSDLF-BACKREST + SEAT IN PAINTED PLANED BEECH PLYWOOD										
CODICE/CODE	FINITURA/FINISHING	Q. KIT	Q. MIN/PACK	A	B	C	D	KG. x1/WT.x1	VOL. x1/UNIT VOL.	
124007-000	■ FAGGIO/BEECH-WOOD		x1	10	330	465	400	465	2,70	mc. 0,07

28 VITE TESTA SVASATA CROCE M6x18 BRUNITA NERA-FISSAGGIO SEDILE/ SCHIENALE FAGGIO									
M6X18 BLACK BURNISHED FLARED PHILIPS SCREW-BEECH SEAT/BACKREST FIXING									
CODICE/CODE	FINITURA/FINISHING	Q. KIT							
117703-195	■ NERO/BLACK	x4							

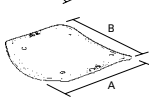
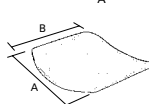
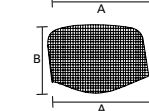
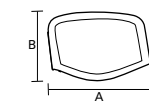
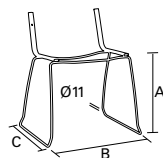
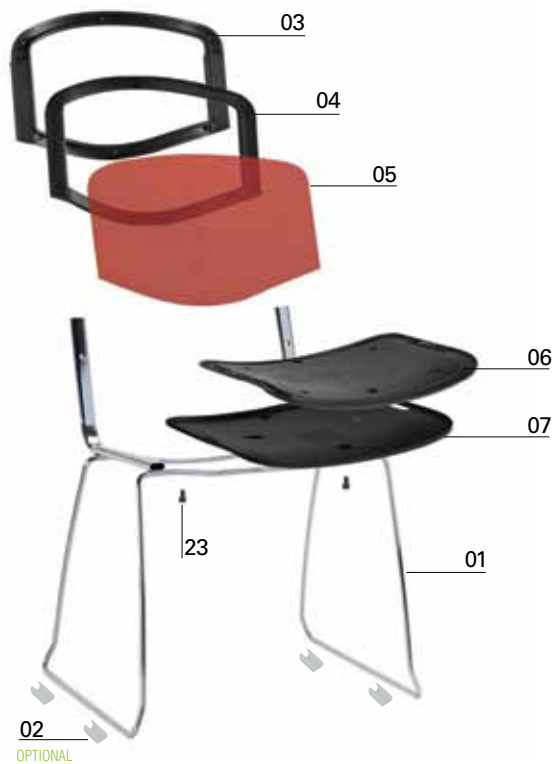

01	SPRITZ-TELAIO CHIUSO IN TONDINO D.11 TAPPI ESCLUSI SPRITZ-SLED WIRE FRAME D.11 CAPS EXCLUDED	Q. KIT	Q. MIN/PACK	A	B	C	KG.x1/WT.x1	VOL.x1/UNIT VOL.
	CODICE/CODE FINITURA/FINISHING 112010-250 ■ CROMATO/CHROME	x1	50	450	580	470	4,00	mc. 0,042
02	CONFEZIONE DI BASI A PINZA ANTIROTAZIONE PER TONDINO COLORE NEUTRO NEUTRAL CLIPS BASE FOR WIRE D.11 PACKAGE	Q. KIT	Q. MIN/PACK					
	CODICE/CODE FINITURA/FINISHING 137006-070 ■ NEUTRO/NEUTRAL	x4	200					
09	BASE PIANA A PINZA IN PE PER TONDO UNIONE SEDIE DOUBLE FLAT CLIPS BASE FOR TUBE	Q. KIT						
	CODICE/CODE FINITURA/FINISHING 134006-021 ■ NEUTRO/NEUTRAL	x4						
03	ISONET-TELAIO SCHIENALE IN PLASTICA CON VITI PER RETE ISONET-OUTER FRAME WITH SCREWS FOR NET	Q. KIT	Q. MIN/PACK	A	B			
	CODICE/CODE FINITURA/FINISHING 132103-003 ■ NERO/BLACK	x1	25	470	345	0,42	mc. 0,006	
04	ISONET-CORNICE SCHIENALE IN PLASTICA PER RETE ISONET-OPEN FRAME FOR ISONET MODEL	Q. KIT	Q. MIN/PACK	A	B			
	CODICE/CODE FINITURA/FINISHING 132103-004 ■ NERO/BLACK	x1	25	470	345	0,31	mc. 0,004	
05	ISONET-RETE PER SCHIENALE ISONET-NET FOR BACK	Q. KIT	Q. MIN/PACK	A	B			
	CODICE/CODE FINITURA/FINISHING 132105-500 □ BIANCO/WHITE 132103-500 ■ NERO/BLACK 132102-500 ■ ROSSO/RED	x1	25	550	400	0,14	mc. 0,0057	
06	90SDI-SEDILE INTERNO IN PLASTICA 90SDI-INNER PLASTIC FOR METAL FRAME	Q. KIT	Q. MIN/PACK	A	B			
	CODICE/CODE FINITURA/FINISHING 132203-002 ■ NERO/BLACK	x1	30	460	400	0,80	mc. 0,004	
07	90SDE-SOTTOSEDILE ESTERNO PLASTICA 90SDE-OUTER PLASTIC SEAT FOR METAL FRAME	Q. KIT	Q. MIN/PACK	A	B			
	CODICE/CODE FINITURA/FINISHING 132203-001 ■ NERO/BLACK	x1	80	410	465	0,40	mc. 0,003	
28	VITE TESTA SVASATA CROCE M6x18 BRUNITA NERA-FISSAGGIO SEDILE/ SCHIENALE FAGGIO M6x18 BLACK BURNISHED FLARED PHILIPS SCREW-BEECH SEAT/BACKREST FIXING	Q. KIT						
	CODICE/CODE FINITURA/FINISHING 117703-195 ■ NERO/BLACK	x4						

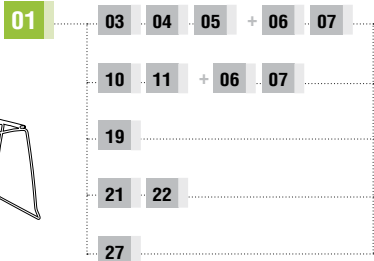

+ 28 + 02 + 09
OPTIONAL OPTIONAL



OPTIONAL 02
BASE PIANA A PINZA
CLIPS BASE



OPTIONAL 09
BASE PIANA A PINZA DOPPIA
DOUBLE FLAT CLIP BASE



SLIDE OPTIONS:

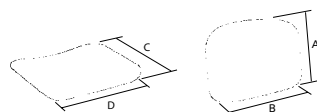
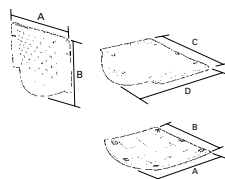
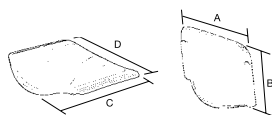
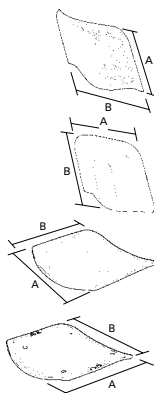

10 90SHI-SCHIENALE INTERNO IN PLASTICA								
90SHI-PLASTIC INTERNAL BACKREST								
CODICE/CODE	FINITURA/FINISHING	Q. KIT	Q. MIN/PACK	A	B	KG. x1/WT.x1	VOL. x1/UNIT VOL.	
132103-002	■ NERO/BLACK	x1	40	330	470	0,60	mc. 0,004	

11 90SHE-COPRISCHIENALE ESTERNO IN PLASTICA								
90SHE-EXTERNAL PLASTIC BACKREST COVER								
CODICE/CODE	FINITURA/FINISHING	Q. KIT	Q. MIN/PACK	A	B	KG. x1/WT.x1	VOL. x1/UNIT VOL.	
132103-001	■ NERO/BLACK	x1	30	475	335	0,40	mc. 0,004	

06 90SDI-SEDILE INTERNO IN PLASTICA								
90SDI-INNER PLASTIC FOR METAL FRAME								
CODICE/CODE	FINITURA/FINISHING	Q. KIT	Q. MIN/PACK	A	B	KG. x1/WT.x1	VOL. x1/UNIT VOL.	
132203-002	■ NERO/BLACK	x1	30	460	400	0,80	mc. 0,004	

07 90SDE-SOTTOSEDILE ESTERNO PLASTICA								
90SDE-OUTER PLASTIC SEAT FOR METAL FRAME								
CODICE/CODE	FINITURA/FINISHING	Q. KIT	Q. MIN/PACK	A	B	KG. x1/WT.x1	VOL. x1/UNIT VOL.	
132203-001	■ NERO/BLACK	x1	80	410	465	0,40	mc. 0,003	

19 NOVX-SEDILE E SCHIENALE IN PLASTICA DISPONIBILI PER TELAIO IN TUBO OVALE E IN TUBO ELLITTICO									
NOVX-PLASTIC SEAT AND BACKREST AVAILABLE FOR OVAL OR ELLIPTIC TUBE FRAME									
CODICE/CODE	FINITURA/FINISHING	Q. KIT	Q. MIN/PACK	A	B	C	D	KG. x1/WT.x1	VOL. x1/UNIT VOL.
134002-001	■ ROSSO/RED RAL3002	x1	20	470	315	460	400	1,21	mc. 0,008
134003-119	■ NERO/BLACK RAL9005	x1	20	470	315	460	400	1,21	mc. 0,008
134015-003	■ BLU/BLUE RAL5002	x1	20	470	315	460	400	1,21	mc. 0,008

21 PRISMA-SCHIENALE E SEDILE IN PLASTICA DISPONIBILI PER TELAIO IN TUBO OVALE E IN TUBO ELLITTICO									
PRISMA-PLASTIC BACKREST AND SEAT AVAILABLE FOR OVAL OR ELLIPTIC TUBE FRAME									
CODICE/CODE	FINITURA/FINISHING	Q. KIT	Q. MIN/PACK	A	B	C	D	KG. x1/WT.x1	VOL. x1/UNIT VOL.
134003-110	■ NERO/BLACK	x1	10	470	330	460	430	1,60	mc. 0,016

22 PRISMA-PANNELLO SEDILE DA TAPPEZZARE								
PRISMA-SEAT PANEL TO UPHOLSTER								
CODICE/CODE	FINITURA/FINISHING	Q. KIT	Q. MIN/PACK	A	B	KG. x1/WT.x1	VOL. x1/UNIT VOL.	
132203-010	■ NERO/BLACK	x1	20	400	400	0,40	mc. 0,004	

27 90SHSDF-SCHIENALE + SEDILE MULTISTRATO VERNICIATO FAGGIO + 4 TESTINE									
90SHSDF-BACKREST + SEAT IN PAINTED PLANED BEECH PLYWOOD									
CODICE/CODE	FINITURA/FINISHING	Q. KIT	Q. MIN/PACK	A	B	C	D	KG. x1/WT.x1	VOL. x1/UNIT VOL.
124007-000	■ FAGGIO/BEECH-WOOD	x1	10	330	465	400	465	2,70	mc. 0,07

28 VITE TESTA SVASATA CROCE M6x18 BRUNITA NERA-FISSAGGIO SEDILE/ SCHIENALE FAGGIO								
M6x18 BLACK BURNISHED FLARED PHILIPS SCREW-BEECH SEAT/BACKREST FIXING								
CODICE/CODE	FINITURA/FINISHING	Q. KIT						
117703-195	■ NERO/BLACK	x4						

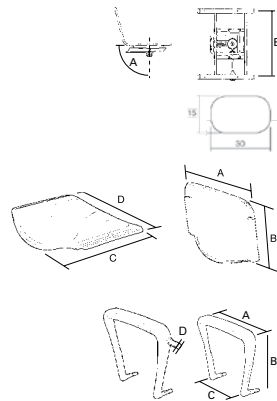

24	92GV-TELAIO PER SEDIA GIREVOLE IN TUBO OVALE 30x15 CON PIASTRA COMANDO A GAS COMPRESO DI SPATOLA, TAPPI ESCLUSI 92GV-SWIVEL CHAIR FRAME IN 30X15 OVAL TUBE WITH GAS CONTROL PLATE INCL. SPATULA, EXCLUDING CAPS									
CODICE/CODE	FINITURA/FINISHING	ATT.BRACC./ARM ATTACH	Q.KIT	Q.MIN/PACK	A	B	KG.x1/WT.x1	VOL.x1/UNIT VOL.		
112003-200	■ NERO/BLACK	14	x1	200	87°	425	2,50	mc. 0,015		
112003-201	■ NERO/BLACK	12	x1	200	87°	425	2,50	mc. 0,015		
112010-200	■ CROMATO/CHROME	14	x1	200	87°	425	2,50	mc. 0,015		
112010-201	■ CROMATO/CHROME	12	x1	200	87°	425	2,50	mc. 0,015		
19	NOVX-SEDILE E SCHIENALE IN PLASTICA DISPONIBILI PER TELAIO IN TUBO OVALE E IN TUBO ELLIPTICO NOVX-PLASTIC SEAT AND BACKREST AVAILABLE FOR OVAL OR ELLIPTIC TUBE FRAME									
CODICE/CODE	FINITURA/FINISHING	ATT.BRACC./ARM ATTACH	Q.KIT	Q.MIN/PACK	A	B	C	D	KG.x1/WT.x1	VOL.x1/UNIT VOL.
134002-001	■ ROSSO/RED	RAL3002	x1	20	470	315	460	400	1,21	mc. 0,008
134003-119	■ NERO/BLACK	RAL9005	x1	20	470	315	460	400	1,21	mc. 0,008
134015-003	■ BLU/BLUE	RAL5002	x1	20	470	315	460	400	1,21	mc. 0,008
12	90B-BRACCIOLO IN NYLON 90BP-BRACCIOLO IN NYLON CON AGGANCIAMENTO PORTA TAVOLETTA 90B-NYLON ARMREST 90BP-WITH WRITING TABLET HOOK									
CODICE/CODE	FINITURA/FINISHING	ATT.BRACC./ARM ATTACH	Q.KIT	Q.MIN/PACK	A	B	C	D	KG.x1/WT.x1	VOL.x1/UNIT VOL.
90BP14	■ NERO/BLACK	14*	x1	20	290	250	190	15x15	0,80	mc. 0,0026
90B14	■ NERO/BLACK	14	x2	20	290	250	190		0,80	mc. 0,0026
90BP	■ NERO/BLACK	12*	x1	20	290	250	190	15x15	0,80	mc. 0,0026
90B	■ NERO/BLACK	12	x2	20	290	250	190		0,80	mc. 0,0026
* GANCIO TAV./HOOK TABLE										
26	CONFEZIONE TAPPI COPRITESTA D.18 NERI BLACK COVER HEAD CAPS D.18 PACKAGE									
CODICE/CODE	FINITURA/FINISHING	DIAMETRO/DIAMETER	Q.KIT	Q.MIN/PACK						
137003-070	■ NERO/BLACK	Ø 18	x4	200						
134103-151	■ NERO/BLACK	Ø 15	x4							
30	CONFEZIONE TAPPI COPRITESTA OVALI 30x15 NERI BLACK OVAL COVER HEAD CAPS 30x15 PACKAGE									
CODICE/CODE	FINITURA/FINISHING	Q.KIT	Q.MIN/PACK							
137003-071	■ NERO/BLACK	x4	200							
28	VITE TESTA SVASATA CROCE M6x18 BRUNITA NERA-FISSAGGIO SEDILE/ SCHIENALE FAGGIO M6x18 BLACK BURNISHED FLARED PHILIPS SCREW-BEECH SEAT/BACKREST FIXING									
CODICE/CODE	FINITURA/FINISHING	Q.KIT								
117703-195	■ NERO/BLACK	x4								

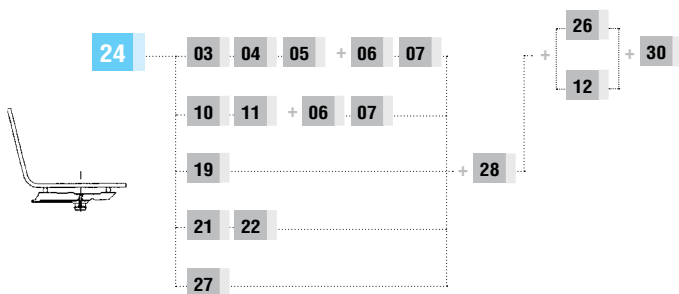

SWIVEL OPTIONS:

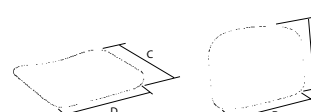
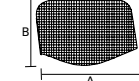
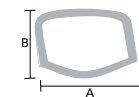

03	ISONET-TELAIO SCHIENALE IN PLASTICA CON VITI PER RETE ISONET-OUTER FRAME WITH SCREWS FOR NET	Q. KIT	Q. MIN/PACK	A	B	KG. x1/WT.x1	VOL. x1/UNIT VOL.
	CODICE/CODE FINITURA/FINISHING						
	132103-003 ■ NERO/BLACK	x1	25	470	345	0,42	mc. 0,006

04	ISONET-CORNICE SCHIENALE IN PLASTICA PER RETE ISONET-OPEN FRAME FOR ISONET MODEL	Q. KIT	Q. MIN/PACK	A	B	KG. x1/WT.x1	VOL. x1/UNIT VOL.
	CODICE/CODE FINITURA/FINISHING						
	132103-004 ■ NERO/BLACK	x1	25	470	345	0,31	mc. 0,004

05	ISONET-RETE PER SCHIENALE ISONET-NET FOR BACK	Q. KIT	Q. MIN/PACK	A	B	KG. x1/WT.x1	VOL. x1/UNIT VOL.
	CODICE/CODE FINITURA/FINISHING						
	132105-500 □ BIANCO/WHITE	x1	25	550	400	0,14	mc. 0,0057
	132103-500 ■ NERO/BLACK	x1	25	550	400	0,14	mc. 0,0057
	132102-500 ■ ROSSO/RED	x1	25	550	400	0,14	mc. 0,0057

06	90SDI-SEDILE INTERNO IN PLASTICA 90SDI-INNER PLASTIC FOR METAL FRAME	Q. KIT	Q. MIN/PACK	A	B	KG. x1/WT.x1	VOL. x1/UNIT VOL.
	CODICE/CODE FINITURA/FINISHING						
	132203-002 ■ NERO/BLACK	x1	30	460	400	0,80	mc. 0,004

07	90SDE-SOTTOSEDILE ESTERNO PLASTICA 90SDE-OUTER PLASTIC SEAT FOR METAL FRAME	Q. KIT	Q. MIN/PACK	A	B	KG. x1/WT.x1	VOL. x1/UNIT VOL.
	CODICE/CODE FINITURA/FINISHING						
	132203-001 ■ NERO/BLACK	x1	80	410	465	0,40	mc. 0,003

10	90SHI-SCHIENALE INTERNO IN PLASTICA 90SHI-PLASTIC INTERNAL BACKREST	Q. KIT	Q. MIN/PACK	A	B	KG. x1/WT.x1	VOL. x1/UNIT VOL.
	CODICE/CODE FINITURA/FINISHING						
	132103-002 ■ NERO/BLACK	x1	40	330	470	0,60	mc. 0,004

11	90SHE-COPRISCHIENALE ESTERNO IN PLASTICA 90SHE-EXTERNAL PLASTIC BACKREST COVER	Q. KIT	Q. MIN/PACK	A	B	KG. x1/WT.x1	VOL. x1/UNIT VOL.
	CODICE/CODE FINITURA/FINISHING						
	132103-001 ■ NERO/BLACK	x1	30	475	335	0,40	mc. 0,004

06	90SDI-SEDILE INTERNO IN PLASTICA 90SDI-INNER PLASTIC FOR METAL FRAME	Q. KIT	Q. MIN/PACK	A	B	KG. x1/WT.x1	VOL. x1/UNIT VOL.
	CODICE/CODE FINITURA/FINISHING						
	132203-002 ■ NERO/BLACK	x1	30	460	400	0,80	mc. 0,004

07	90SDE-SOTTOSEDILE ESTERNO PLASTICA 90SDE-OUTER PLASTIC SEAT FOR METAL FRAME	Q. KIT	Q. MIN/PACK	A	B	KG. x1/WT.x1	VOL. x1/UNIT VOL.
	CODICE/CODE FINITURA/FINISHING						
	132203-001 ■ NERO/BLACK	x1	80	410	465	0,40	mc. 0,003

21	PRISMA-SCHIENALE E SEDILE IN PLASTICA DISPONIBILI PER TELAIO IN TUBO OVALE E IN TUBO ELLITTICO PRISMA-PLASTIC BACKREST AND SEAT AVAILABLE FOR OVAL OR ELLIPTIC TUBE FRAME	Q. KIT	Q. MIN/PACK	A	B	C	D	KG. x1/WT.x1	VOL. x1/UNIT VOL.
	CODICE/CODE FINITURA/FINISHING								
	134003-110 ■ NERO/BLACK	x1	10	470	330	460	430	1,60	mc. 0,016

22	PRISMA-PANNELLO SEDILE DA TAPPEZZARE PRISMA-SEAT PANEL TO UPHOLSTER	Q. KIT	Q. MIN/PACK	A	B	KG. x1/WT.x1	VOL. x1/UNIT VOL.
	CODICE/CODE FINITURA/FINISHING						
	132203-010 ■ NERO/BLACK	x1	20	400	400	0,40	mc. 0,004

27	90SHSDLF-SCHIENALE + SEDILE MULTISTRATO VERNICIATO FAGGIO + 4 TESTINE 90SHSDLF-BACKREST + SEAT IN PAINTED PLANED BEECH PLYWOOD	Q. KIT	Q. MIN/PACK	A	B	C	D	KG. x1/WT.x1	VOL. x1/UNIT VOL.
	CODICE/CODE FINITURA/FINISHING								
	124007-000 ■ FAGGIO/BEECH-WOOD	x1	10	330	465	400	465	2,70	mc. 0,07

28	VITE TESTA SVASATA CROCE M6x18 BRUNITA NERA-FISSAGGIO SEDILE/ SCHIENALE FAGGIO M6X18 BLACK BURNISHED FLARED PHILIPS SCREW-BEECH SEAT/BACKREST FIXING	Q. KIT							
	CODICE/CODE FINITURA/FINISHING								
	117703-195 ■ NERO/BLACK	x4							

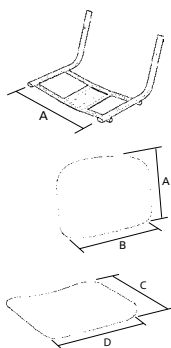

25	92PV-TELAIO IN TUBO OVALE O ELITTICO PER PANCA VERNICIATA 92PV-OVAL OR ELIPTIC TUBE FRAME FOR PAINTED BENCH							
CODICE/CODE	FINITURA/FINISHING	ATT. BRACC./ARM ATTACH	Q. KIT	Q. MIN/PACK	A	KG. x1/WT.x1	VOL. x1/UNIT VOL.	
110703-061	■ NERO/BLACK	12 OVALE/OVAL	x1	200	425	2,20	mc. 0,015	
110703-062	■ NERO/BLACK	14 OVALE/OVAL	x1	200	425	2,20	mc. 0,015	
27	90SHSDLF-SCHIENALE + SEDILE MULTISTRATO VERNICIATO FAGGIO + 4 TESTINE 90SHSDLF-BACKREST + SEAT IN PAINTED PLANED BEECH PLYWOOD							
CODICE/CODE	FINITURA/FINISHING	Q. KIT	Q. MIN/PACK	A	B	C	D	KG. x1/WT.x1
124007-000	■ FAGGIO/BEECH-WOOD	x1	10	330	465	400	465	2,70
26	CONFEZIONE TAPPI COPRITESTA D. 18 NERI BLACK COVER HEAD CAPS D.18 PACKAGE							
CODICE/CODE	FINITURA/FINISHING	DIAMETRO/DIAMETER	Q. KIT	Q. MIN/PACK				
134103-180	■ NERO/BLACK	Ø 18	x4	200				
134103-151	■ NERO/BLACK	Ø 15	x4	200				
30	TAPPO COPRITESTA OVALE 30x15 BLACK OVAL COVER HEAD CAPS 30x15 PACKAGE							
CODICE/CODE	FINITURA/FINISHING	Q. KIT	Q. MIN/PACK					
137003-071	■ NERO/BLACK	x4	200					
28	VITE TESTA SVASATA CROCE M6x18 BRUNITA NERA-FISSAGGIO SEDILE/ SCHIENALE FAGGIO M6x18 BLACK BURNISHED FLARED PHILIPS SCREW-BEECH SEAT/BACKREST FIXING							
CODICE/CODE	FINITURA/FINISHING	Q. KIT						
117703-195	■ NERO/BLACK	x4						

PER I COMPONENTI DELLA PANCA VAI A PAG. 337
FOR THE BENCH COMPONENTS GO TO PAGE 337

OPTIONAL PANCA
BENCH OPTIONAL



OPTIONAL CONNETTORE PANCA
OPTIONAL BENCH CONNECTOR

