

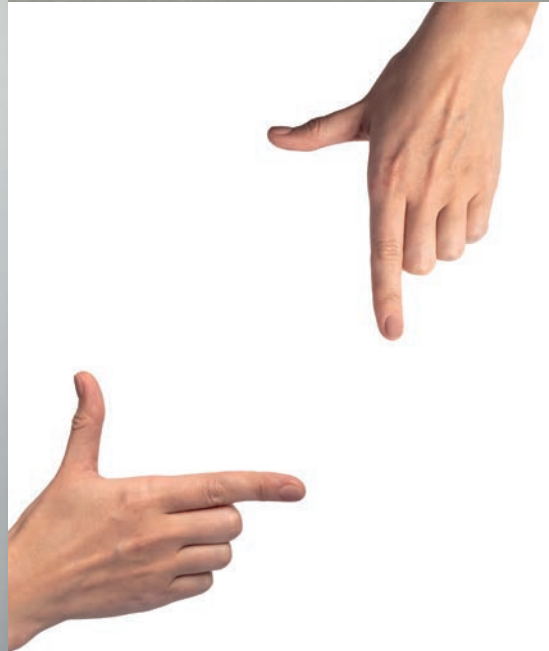

BEYOND **Solutions**





**equity**

---



# equity



---

side

4 legs

4 legs with castors

swivel

bench

## equity showing

---

### features



trolley  
available



Une **assise ample et confortable**. Son dossier, de grande personnalité, possède une forme originale. Ce modèle est proposé avec un panneau en plastique ajouré au dessin caractéristique, dans une version à tapisser ou résillée.

Cette chaise, conçue pour le **Bureau**, s'adapte à tout type d'utilisation grâce à un grand assortiment de composants, avec toutes les options de châssis.

*Un **asiento amplio y confortable**. El respaldo, con su forma atractiva, está disponible con panel de plástico perforado y un diseño característico que lo distingue, y en la versión para tapizar y en malla.*

*Creado para el **ambiente de la oficina**, resulta idóneo para todas las utilizaciones por su amplio surtido de componentes, con todas las opciones para la estructura.*

# equity

4-legs



equity-chariot porte-chaises avec accessoires  
equity-carro para sillas con accesorios

code	finishing	q.kit
110803-340	● noir/negro	x1



## 01 pinko-châssis quatre pieds fixe pour accoudoirs sans embouts pinko-estructura cuatro patas fija para brazos sin tapones

code	finishing	q.kit	q.pack	a	b	c	kg.x1	vol.x1
112603-040	● noir/negro	x1	80	450	530	530	3,20	mc. 0.035
112604-040	● gris/gris	x1	80	450	530	530	3,20	mc. 0.035
112610-040	● chromé/cromado	x1	80	450	530	530	3,20	mc. 0.035

## 02 pack embouts tête sphérique 025 paquete de tacos con cabeza esférica d.25

code	finishing	q.kit	q.pack
137003-075	● noir/negro	x4	120

## 03 equity-dossier portant en plastique equity-respaldo de plástico

code	finishing	q.kit	q.pack	a	b	kg.x1	vol.x1
132103-016	● noir/negro	x1	10	440	360	0,67	mc. 0.0085
132105-016	○ blanc/blanco	x1	10	440	360	0,67	mc. 0.0085

## 04 equity-cadre dossier en plastique pour treillis equity-marco respaldo de plástico para malla

code	finishing	q.kit	q.pack	a	b	kg.x1	vol.x1
132103-018	● noir/negro	x1	20	425	350	0,36	mc. 0.0045
132105-082	○ blanc/blanco	x1	20	425	350	0,36	mc. 0.0045

## 05 pinko-siège interne (habillable) pinko-asiento interno (tapizable)

code	finishing	q.kit	q.pack	a	b	kg.x1	vol.x1
132203-025	● noir/negro	x1	10	465	470	0,73	mc. 0.006

## 06 pinko-siège externe en plastique pinko-asiento externo de plástico

code	finishing	q.kit	q.pack	a	b	kg.x1	vol.x1
132203-026	● noir/negro	x1	20	465	470	0,62	mc. 0.007
132205-026	○ blanc/blanco	x1	20	465	470	0,62	mc. 0.007

## 07 equity-paire d'accoudoirs en plastique equity-pareja de brazos de plástico

code	finishing	q.kit	q.pack	a	b	kg.x1	vol.x1
131703-052	● noir/negro	x1	10	375	220	0,87	mc. 0.0062
131705-052	○ blanc/blanco	x1	10	375	220	0,87	mc. 0.0062

## 08 pinko/logan-attelage latéral mâle + femelle chromé pinko/logan-enganche lateral macho+hembra cromado

code	finishing	q.kit	q.pack	kg.x1	vol.x1
113410-100	● chromé/cromado	x1	100	0,13	mc. 0.0004

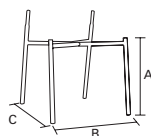

01



07



03

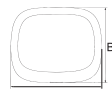

04

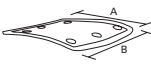

05



06



08

main component sizes

optionals

# equity

## 4-legs/tablet accessories

main component sizes



09



**09** equity-paire d'accoudoirs en plastique avec crochet tablette droit  
equity-pareja brazos de plástico con gancho pala derecho

code	finishing	q.kit	q.pack	a	b	kg.x1	vol.x1
131703-053	● noir/negro	x1	10	375	220	0,88	mc. 0,0062

TLT  
tablet



TLT2  
tablet



TLT3  
tablet



BEAN  
tablet



TL02  
tablet



SPT2  
mechanism tablet



SPTA  
mechanism antipanic



for writing tablet options, see page 192/193

## 4-legs/backrest options

main component sizes



03



10



**03** equity-dossier portant en plastique  
equity-respaldo de plástico

code	finishing	q.kit	q.pack	a	b	kg.x1	vol.x1
132103-016	● noir/negro	x1	10	440	360	0,67	mc. 0,0085
132105-016	○ blanc/blanco	x1	10	440	360	0,67	mc. 0,0085

**10** equity-panneau dossier à trous en plastique  
equity-galleta respaldo perforado de plástico

code	finishing	q.kit	q.pack	a	b	kg.x1	vol.x1
132103-017	● noir/negro	x1	20	425	350	0,45	mc. 0,0045
132106-017	● neutre/neutro	x1	20	425	350	0,45	mc. 0,0045

main component sizes

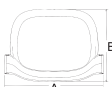

03



10



**03** equity-dossier portant en plastique  
equity-respaldo de plástico

code	finishing	q.kit	q.pack	a	b	kg.x1	vol.x1
132103-016	● noir/negro	x1	10	440	360	0,67	mc. 0,0085
132105-016	○ blanc/blanco	x1	10	440	360	0,67	mc. 0,0085

**10** equity-panneau dossier à trous en plastique  
equity-galleta respaldo perforado de plástico

code	finishing	q.kit	q.pack	a	b	kg.x1	vol.x1
132103-017	● noir/negro	x1	20	425	350	0,45	mc. 0,0045
132106-017	● neutre/neutro	x1	20	425	350	0,45	mc. 0,0045

# equity

4-legs for castors



main component sizes

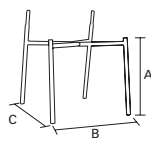

11



07



03

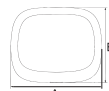

04



05

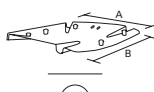

06



**11** pinko-châssis pour chaise 4 pieds prévu pour 4 roulettes + 4 embouts porte roulettes  
pinko-estructura para silla 4 patas predispuesta para 4 ruedas + 4 tapones portaruedas

code	finishing	q.kit	q.pack	a	b	c	kg.x1	vol.x1
112603-041	● noir/negro	x1	80	390	530	530	3,20	mc. 0.035
112604-041	● gris/gris	x1	80	390	530	530	3,20	mc. 0.035
112610-041	● chromé/cromado	x1	80	390	530	530	3,20	mc. 0.035

**12** double roulette ø50 en desmopan tige montée  
rueda doble d. 50 de desmopan con perno montado

code	finishing	q.kit
134403-003	● nero/black	x4

**03** equity-dossier portant en plastique  
equity-respaldo de plástico

code	finishing	q.kit	q.pack	a	b	kg.x1	vol.x1
132103-016	● noir/negro	x1	10	440	360	0,67	mc. 0.0085
132105-016	○ blanc/blanco	x1	10	440	360	0,67	mc. 0.0085

**04** equity-cadre dossier en plastique pour treillis  
equity-marco respaldo de plástico para malla

code	finishing	q.kit	q.pack	a	b	kg.x1	vol.x1
132103-018	● noir/negro	x1	20	425	350	0,36	mc. 0.0045
132105-082	○ blanc/blanco	x1	20	425	350	0,36	mc. 0.0045

**05** pinko-siège interne (habillable)  
pinko-asiento interno (tapizable)

code	finishing	q.kit	q.pack	a	b	kg.x1	vol.x1
132203-025	● noir/negro	x1	10	465	470	0,73	mc. 0.006

**06** pinko-siège externe en plastique  
pinko-asiento externo de plástico

code	finishing	q.kit	q.pack	a	b	kg.x1	vol.x1
132203-026	● noir/negro	x1	20	465	470	0,62	mc. 0.007
132205-026	○ blanc/blanco	x1	20	465	470	0,62	mc. 0.007

**07** equity-paire d'accoudoirs en plastique  
equity-pareja de brazos de plástico

code	finishing	q.kit	q.pack	a	b	kg.x1	vol.x1
131703-052	● noir/negro	x1	10	375	220	0,87	mc. 0.0062
131705-052	○ blanc/blanco	x1	10	375	220	0,87	mc. 0.0062

equity-chariot porte-chaises avec accessoires  
equity-carro para sillas con accesorios

code	finishing	q.kit
110803-340	● noir/negro	x1

# equity

## 4-legs for castors/tablet accessories

main component sizes



09



### 09 equity-paire d'accoudoirs en plastique avec crochet tablette droit

equity-pareja brazos de plástico con gancho pala derecho

code	finishing	q.kit	q.pack	a	b	kg.x1	vol.x1
131703-053	● noir/negro	x1	10	375	220	0,88	mc. 0,0062

TLT  
tablet



TLT2  
tablet



TLT3  
tablet



BEAN  
tablet



TL02  
tablet



SPT2  
mechanism tablet



SPTA  
mechanism antipanic



for writing tablet options, see page 192/193

## 4-legs for castors/backrest options

main component sizes

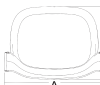

03



10



### 03 equity-dossier portant en plastique

equity-respaldo de plástico

code	finishing	q.kit	q.pack	a	b	kg.x1	vol.x1
132103-016	● noir/negro	x1	10	440	360	0,67	mc. 0,0085
132105-016	○ blanc/blanco	x1	10	440	360	0,67	mc. 0,0085

### 10 equity-panneau dossier à trous en plastique

equity-galleta respaldo perforado de plástico

code	finishing	q.kit	q.pack	a	b	kg.x1	vol.x1
132103-017	● noir/negro	x1	20	425	350	0,45	mc. 0,0045
132106-017	● neutre/neutro	x1	20	425	350	0,45	mc. 0,0045

main component sizes

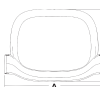

03



10



### 03 equity-dossier portant en plastique

equity-respaldo de plástico

code	finishing	q.kit	q.pack	a	b	kg.x1	vol.x1
132103-016	● noir/negro	x1	10	440	360	0,67	mc. 0,0085
132105-016	○ blanc/blanco	x1	10	440	360	0,67	mc. 0,0085

### 10 equity-panneau dossier à trous en plastique

equity-galleta respaldo perforado de plástico

code	finishing	q.kit	q.pack	a	b	kg.x1	vol.x1
132103-017	● noir/negro	x1	20	425	350	0,45	mc. 0,0045
132106-017	● neutre/neutro	x1	20	425	350	0,45	mc. 0,0045



# equity

## slide



main component sizes

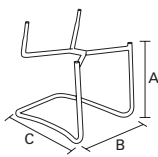

13



07



03



10

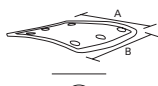

05

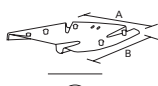

06

### 13 pinko-base coulissante en tube asform ø25 embouts exclus pinko-base patin tubular asform d. 25 tapones excluidos

code	finishing	q.kit	q.pack	a	b	c	kg.x1	vol.x1
110503-093	● noir/negro	x1	40	450	550	550	4,60	mc. 0,06
110504-093	● gris/gris	x1	40	450	550	550	4,60	mc. 0,06
110510-093	● chromé/cromado	x1	40	450	550	550	4,60	mc. 0,06

### 14 pare-chocs tête bombée ø18 tope cabeza convexa d.18

code	finishing	q.kit
134403-101	● nero/black	x4

### 03 equity-dossier portant en plastique equity-respaldo de plástico

code	finishing	q.kit	q.pack	a	b	kg.x1	vol.x1
132103-016	● noir/negro	x1	10	440	360	0,67	mc. 0,0085
132105-016	○ blanc/blanco	x1	10	440	360	0,67	mc. 0,0085

### 10 equity-panneau dossier à trous en plastique equity-galleta respaldo perforado de plástico

code	finishing	q.kit	q.pack	a	b	kg.x1	vol.x1
132103-017	● noir/negro	x1	20	425	350	0,45	mc. 0,0045
132106-017	● neutre/neutro	x1	20	425	350	0,45	mc. 0,0045

### 05 pinko-siège interne (habillable) pinko-asiento interno (tapizable)

code	finishing	q.kit	q.pack	a	b	kg.x1	vol.x1
132203-025	● noir/negro	x1	10	465	470	0,73	mc. 0,006

### 06 pinko-siège externe en plastique pinko-asiento externo de plástico

code	finishing	q.kit	q.pack	a	b	kg.x1	vol.x1
132203-026	● noir/negro	x1	20	465	470	0,62	mc. 0,007
132205-026	○ blanc/blanco	x1	20	465	470	0,62	mc. 0,007

### 07 equity-paire d'accoudoirs en plastique equity-pareja de brazos de plástico

code	finishing	q.kit	q.pack	a	b	kg.x1	vol.x1
131703-052	● noir/negro	x1	10	375	220	0,87	mc. 0,0062
131705-052	○ blanc/blanco	x1	10	375	220	0,87	mc. 0,0062

# equity

## slide/backrest options

main component sizes

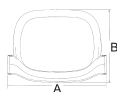

03

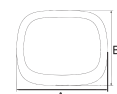

04



### 03 equity-dossier portant en plastique equity-respaldo de plástico

code	finishing	q.kit	q.pack	a	b	kg.x1	vol.x1
132103-016	● noir/negro	x1	10	440	360	0,67	mc. 0.0085
132105-016	○ blanc/blanco	x1	10	440	360	0,67	mc. 0.0085

### 04 equity-cadre dossier en plastique pour treillis equity-marco respaldo de plástico para malla

code	finishing	q.kit	q.pack	a	b	kg.x1	vol.x1
132103-018	● noir/negro	x1	20	425	350	0,36	mc. 0.0045
132105-082	○ blanc/blanco	x1	20	425	350	0,36	mc. 0.0045

main component sizes

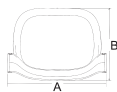

03

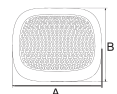

10



### 03 equity-dossier portant en plastique equity-respaldo de plástico

code	finishing	q.kit	q.pack	a	b	kg.x1	vol.x1
132103-016	● noir/negro	x1	10	440	360	0,67	mc. 0.0085
132105-016	○ blanc/blanco	x1	10	440	360	0,67	mc. 0.0085

### 10 equity-panneau dossier à trous en plastique equity-galleta respaldo perforado de plástico

code	finishing	q.kit	q.pack	a	b	kg.x1	vol.x1
132103-017	● noir/negro	x1	20	425	350	0,45	mc. 0.0045
132106-017	● neutre/neutro	x1	20	425	350	0,45	mc. 0.0045

# equity

## swivel

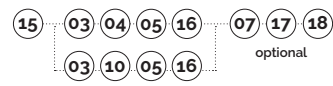

main component sizes

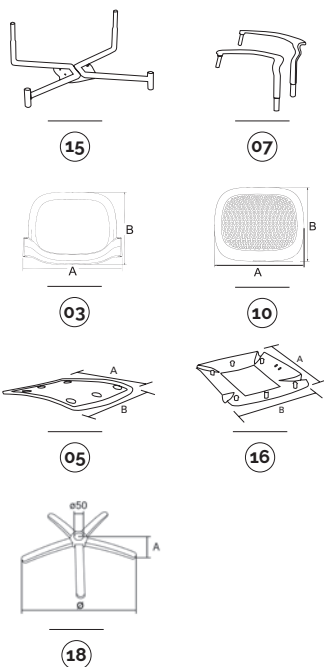

optionals

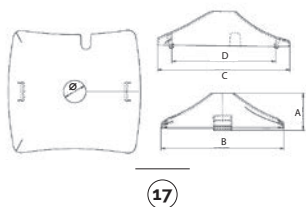

**15** pinko-support pivotant au gaz sans embouts  
pinko-soporte versión giratoria con mecanismo de gas sin tapones

code	finishing	q.kit	q.pack	kg.x1	vol.x1
112603-045	● noir/negro	x1	80	2,60	mc. 0.005
112604-045	● gris/gris	x1	80	2,60	mc. 0.005

**03** equity-dossier portant en plastique  
equity-respaldo de plástico

code	finishing	q.kit	q.pack	a	b	kg.x1	vol.x1
132103-016	● noir/negro	x1	10	440	360	0,67	mc. 0.0085
132105-016	○ blanc/blanco	x1	10	440	360	0,67	mc. 0.0085

**10** equity-panneau dossier à trous en plastique  
equity-galleta respaldo perforado de plástico

code	finishing	q.kit	q.pack	a	b	kg.x1	vol.x1
132103-017	● noir/negro	x1	20	425	350	0,45	mc. 0.0045
132106-017	● neutre/neutro	x1	20	425	350	0,45	mc. 0.0045

**05** pinko-siège interne (habillable)  
pinko-asiento interno (tapizable)

code	finishing	q.kit	q.pack	a	b	kg.x1	vol.x1
132203-025	● noir/negro	x1	10	465	470	0,73	mc. 0.006

**16** pinko-renfort d'assise externe en plastique pour châssis banquette et pivotant  
pinko-parte inferior asiento externo de plástico para estructura banqueta y versión giratoria

code	finishing	q.kit	q.pack	a	b	kg.x1	vol.x1
132203-027	● noir/negro	x1	20	465	470	0,62	mc. 0.007

**07** equity-paire d'accoudoirs en plastique  
equity-pareja de brazos de plástico

code	finishing	q.kit	q.pack	a	b	kg.x1	vol.x1
131703-052	● noir/negro	x1	10	375	220	0,87	mc. 0.0062
131705-052	○ blanc/blanco	x1	10	375	220	0,87	mc. 0.0062

**17** cpg-couverture en plastique pour châssis pivotant  
cpg-cubierta de plástico para estructura versión giratoria

code	finishing	q.kit	q.pack	a	b	c	d	ø	kg.x1	vol.x1
130903-000	● noir/negro	x1	50	60	200	210	167	36	0,1	mc. 0.0015

**18** b40-base en métal avec cache-soudure  
b40-base de metal con embellecedor soldadura

code	finishing	q.kit	q.pack	a	ø	kg.x1	vol.x1
110210-027	● chromé/cromado	x1	5	60	640	2,85	mc. 0.014

CPG  
plastic cover for swivel frame



# equity

swivel/backrest options

main component sizes

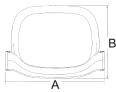

03

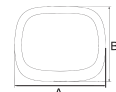

04



**03 equity-dossier portant en plastique**  
equity-respaldo de plástico

code	finishing	q.kit	q.pack	a	b	kg.x1	vol.x1
132103-016	● noir/negro	x1	10	440	360	0,67	mc. 0.0085
132105-016	○ blanc/blanco	x1	10	440	360	0,67	mc. 0.0085

**04 equity-cadre dossier en plastique pour treillis**  
equity-marco respaldo de plástico para malla

code	finishing	q.kit	q.pack	a	b	kg.x1	vol.x1
132103-018	● noir/negro	x1	20	425	350	0,36	mc. 0.0045
132105-082	○ blanc/blanco	x1	20	425	350	0,36	mc. 0.0045

main component sizes

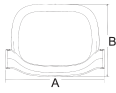

03

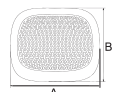

10



**03 equity-dossier portant en plastique**  
equity-respaldo de plástico

code	finishing	q.kit	q.pack	a	b	kg.x1	vol.x1
132103-016	● noir/negro	x1	10	440	360	0,67	mc. 0.0085
132105-016	○ blanc/blanco	x1	10	440	360	0,67	mc. 0.0085

**10 equity-panneau dossier à trous en plastique**  
equity-galleta respaldo perforado de plástico

code	finishing	q.kit	q.pack	a	b	kg.x1	vol.x1
132103-017	● noir/negro	x1	20	425	350	0,45	mc. 0.0045
132106-017	● neutre/neutro	x1	20	425	350	0,45	mc. 0.0045

# equity

## bench



main component sizes

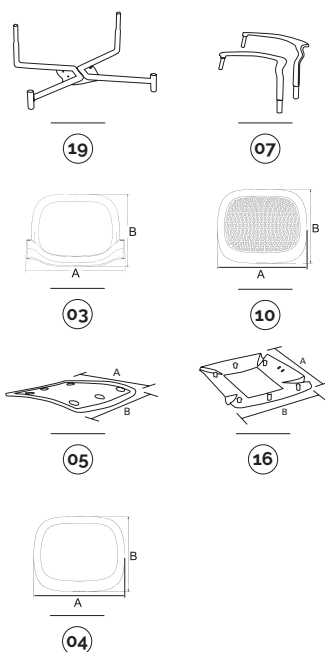

**19** pinko-structure pour banquette sans embouts  
pinko-estructura bancada sin tapones

code	finishing	q.kit	q.pack	kg.x1	vol.x1
110703-072	● noir/black	x1	80	2,50	mc. 0.005
110704-072	● grigio/grey	x1	80	2,50	mc. 0.005

**03** equity-dossier portant en plastique  
equity-respaldo de plástico

code	finishing	q.kit	q.pack	a	b	kg.x1	vol.x1
132103-016	● noir/negro	x1	10	440	360	0,67	mc. 0.0085
132105-016	○ blanc/blanco	x1	10	440	360	0,67	mc. 0.0085

**10** equity-panneau dossier à trous en plastique  
equity-galleta respaldo perforado de plástico

code	finishing	q.kit	q.pack	a	b	kg.x1	vol.x1
132103-017	● noir/negro	x1	20	425	350	0,45	mc. 0.0045
132106-017	● neutre/neutro	x1	20	425	350	0,45	mc. 0.0045

**05** pinko-siège interne (habillable)  
pinko-asiento interno (tapizable)

code	finishing	q.kit	q.pack	a	b	kg.x1	vol.x1
132203-025	● noir/negro	x1	10	465	470	0,73	mc. 0.006

**16** pinko-renfort d'assise externe en plastique pour châssis banquette et pivotant  
pinko-parte inferior asiento externo de plástico para estructura bancada y versión giratoria

code	finishing	q.kit	q.pack	a	b	kg.x1	vol.x1
132203-027	● noir/negro	x1	20	465	470	0,62	mc. 0.007

**07** equity-paire d'accoudoirs en plastique  
equity-pareja de brazos de plástico

code	finishing	q.kit	q.pack	a	b	kg.x1	vol.x1
131703-052	● noir/negro	x1	10	375	220	0,87	mc. 0.0062
131705-052	○ blanc/blanco	x1	10	375	220	0,87	mc. 0.0062

**04** equity-cadre dossier en plastique pour treillis  
equity-marco respaldo de plástico para malla

code	finishing	q.kit	q.pack	a	b	kg.x1	vol.x1
132103-018	● noir/negro	x1	20	425	350	0,36	mc. 0.0045
132105-082	○ blanc/blanco	x1	20	425	350	0,36	mc. 0.0045

for the bench components, see page 201

OPTIONAL  
bench connector

E-USB **NEW**  
bench plug



JIM **NEW**  
bench leg

APOLL  
bench arm



plastic

90GM  
bench leg

90GF  
bench leg

100GM  
bench leg

200GM  
bench leg

PIONEER  
bench arm



metal

CUT  
bench leg

SLIM  
bench leg

CUT  
bench arm

SLIM  
bench arm



aluminium

optionals

