

# equity

## swivel

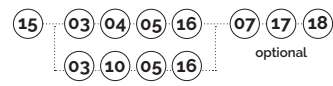

main component sizes

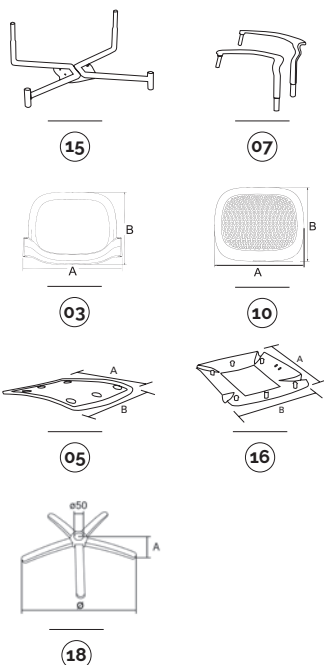

optionals

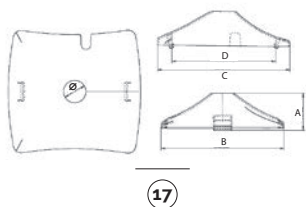

**15** pinko-support pivotant au gaz sans embouts  
pinko-soporte versión giratoria con mecanismo de gas sin tapones

code	finishing	q.kit	q.pack	kg.x1	vol.x1
112603-045	● noir/negro	x1	80	2,60	mc. 0.005
112604-045	● gris/gris	x1	80	2,60	mc. 0.005

**03** equity-dossier portant en plastique  
equity-respaldo de plástico

code	finishing	q.kit	q.pack	a	b	kg.x1	vol.x1
132103-016	● noir/negro	x1	10	440	360	0,67	mc. 0.0085
132105-016	○ blanc/blanco	x1	10	440	360	0,67	mc. 0.0085

**10** equity-panneau dossier à trous en plastique  
equity-galleta respaldo perforado de plástico

code	finishing	q.kit	q.pack	a	b	kg.x1	vol.x1
132103-017	● noir/negro	x1	20	425	350	0,45	mc. 0.0045
132106-017	● neutre/neutro	x1	20	425	350	0,45	mc. 0.0045

**05** pinko-siège interne (habillable)  
pinko-asiento interno (tapizable)

code	finishing	q.kit	q.pack	a	b	kg.x1	vol.x1
132203-025	● noir/negro	x1	10	465	470	0,73	mc. 0.006

**16** pinko-renfort d'assise externe en plastique pour châssis banquette et pivotant  
pinko-parte inferior asiento externo de plástico para estructura banqueta y versión giratoria

code	finishing	q.kit	q.pack	a	b	kg.x1	vol.x1
132203-027	● noir/negro	x1	20	465	470	0,62	mc. 0.007

**07** equity-paire d'accoudoirs en plastique  
equity-pareja de brazos de plástico

code	finishing	q.kit	q.pack	a	b	kg.x1	vol.x1
131703-052	● noir/negro	x1	10	375	220	0,87	mc. 0.0062
131705-052	○ blanc/blanco	x1	10	375	220	0,87	mc. 0.0062

**17** cpg-couverture en plastique pour châssis pivotant  
cpg-cubierta de plástico para estructura versión giratoria

code	finishing	q.kit	q.pack	a	b	c	d	ø	kg.x1	vol.x1
130903-000	● noir/negro	x1	50	60	200	210	167	36	0,1	mc. 0.0015

**18** b40-base en métal avec cache-soudure  
b40-base de metal con embellecedor soldadura

code	finishing	q.kit	q.pack	a	ø	kg.x1	vol.x1
110210-027	● chromé/cromado	x1	5	60	640	2,85	mc. 0.014

CPG  
plastic cover for swivel frame



# equity

## swivel/backrest options

main component sizes

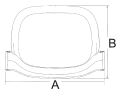

03

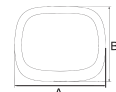

04



### 03 equity-dossier portant en plastique equity-respaldo de plástico

code	finishing	q.kit	q.pack	a	b	kg.x1	vol.x1
132103-016	● noir/negro	x1	10	440	360	0,67	mc. 0.0085
132105-016	○ blanc/blanco	x1	10	440	360	0,67	mc. 0.0085

### 04 equity-cadre dossier en plastique pour treillis equity-marco respaldo de plástico para malla

code	finishing	q.kit	q.pack	a	b	kg.x1	vol.x1
132103-018	● noir/negro	x1	20	425	350	0,36	mc. 0.0045
132105-082	○ blanc/blanco	x1	20	425	350	0,36	mc. 0.0045

main component sizes

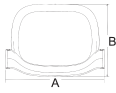

03

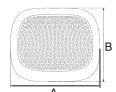

10



### 03 equity-dossier portant en plastique equity-respaldo de plástico

code	finishing	q.kit	q.pack	a	b	kg.x1	vol.x1
132103-016	● noir/negro	x1	10	440	360	0,67	mc. 0.0085
132105-016	○ blanc/blanco	x1	10	440	360	0,67	mc. 0.0085

### 10 equity-panneau dossier à trous en plastique equity-galleta respaldo perforado de plástico

code	finishing	q.kit	q.pack	a	b	kg.x1	vol.x1
132103-017	● noir/negro	x1	20	425	350	0,45	mc. 0.0045
132106-017	● neutre/neutro	x1	20	425	350	0,45	mc. 0.0045