



I *feel* inspired



Designed by:  
**STEFANO BETTIO**



Configurator available



Certified

*feel*

L'evoluzione della monoscocca. La particolare fotoincisione del sedile e il doppio disegno sovrapposto dello schienale forato, regalano un carattere deciso ad una sedia che fa della comodità il suo punto di forza. Otto colori di tendenza per la scocca e gli accessori, e il pannellino tappezzabile per il sedile permettono di giocare con le combinazioni cromatiche. Disponibile in un ampio numero di versioni che comprendono anche quelle dedicate all'outdoor.

*The evolution of the monoshell. The distinct photoengraving of the seat and superimposed design of the perforated backrest give a definite character to a chair that makes comfort its strength. Eight colours for the shell and accessories, and upholstery panel for the seat allow you to play with various colour and style combinations. Available in numerous versions, including those dedicated to the outdoors.*



CERTIFIED BY  
**BIFMA**



CERTIFIED BY  
**CATAS**



BIFMA TEST



EN 16139

FOLLOW US ON



albacomponents



FEEL

■ . inspired by ALBA

SLIDE



4 LEGS



SWIVEL



BENCH



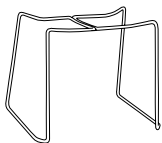
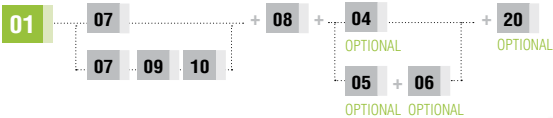
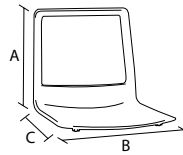
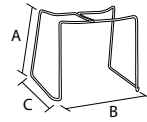
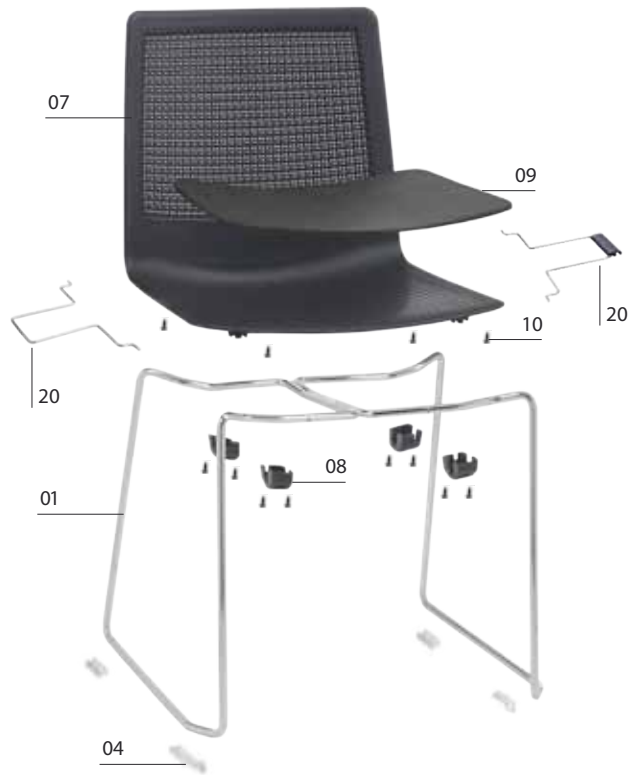

01 FEEL-TELAIO A SLITTA IN TONDINO D.12 FEEL-SLIDE WIRE FRAME D.12									
CODICE/CODE	FINITURA/FINISHING	Q. KIT	Q. MIN/PACK	A	B	C	KG. x1/WT.x1	VOL. x1/UNIT VOL.	
113410-057	■ CROMATO/CHROME	x1	100	460	530	470	3,75	mc. 0,03	
04 BTf-KIT PIEDINI BTf-KIT FEET									
CODICE/CODE	FINITURA/FINISHING	Q. KIT	Q. MIN/PACK				KG. x1/WT.x1		
134306-001	□ NEUTRO/NEUTRAL	x1	100				0,05		
05 BTfA-KIT PIEDINI CON GANCI BTfA-KIT FEET WITH HOOKS									
CODICE/CODE	FINITURA/FINISHING	Q. KIT	Q. MIN/PACK				KG. x1/WT.x1		
134306-002	□ NEUTRO/NEUTRAL	x1	100				0,06		
06 PPTf-TAPPO PER FISSAGGIO PAVIMENTO PPTf-CAP FOR FIXING TO THE FLOOR									
CODICE/CODE	FINITURA/FINISHING	Q. KIT	Q. MIN/PACK				KG. x1/WT.x1		
134306-003	□ NEUTRO/NEUTRAL	x2	100				0,03		
07 FEEL-SCOCCA INTERA MODELLO FEEL FEEL-PLASTIC SHELL MODEL FEEL									
CODICE/CODE	FINITURA/FINISHING	Q. KIT	Q. MIN/PACK	A	B	C	KG. x1/WT.x1	VOL. x1/UNIT VOL.	
133915-060	■ BLU/BLUE RAL5014	x1	10	420	450	430	1,70	mc. 0,02	
133907-060	■ ARANCIO/ORANGE RAL2003	x1	10	420	450	430	1,70	mc. 0,02	
133903-060	■ NERO/BLACK RAL9005	x1	10	420	450	430	1,70	mc. 0,02	
133916-060	■ VERDE/GREEN PANTONE 7495EL	x1	10	420	450	430	1,70	mc. 0,02	
133905-060	□ BIANCO/WHITE 218	x1	10	420	450	430	1,70	mc. 0,02	
133904-060	■ GRIGIO/GREY RAL7003	x1	10	420	450	430	1,70	mc. 0,02	
133907-059	■ SABBIA/SAND RAL1019	x1	10	420	450	430	1,70	mc. 0,02	
133902-060	■ ROSSO/RED RAL527	x1	10	420	450	430	1,70	mc. 0,02	
133905-059	□ BIANCO/WHITE 218 autoestinguente/fire retardant	x1	10	420	450	430	1,70	mc. 0,02	
08 FEEL-CONFEZIONE ACCESSORI PER SCOCCA FEEL PER TONDINO FEEL-ACCESSORY PACK FOR WIRE FRAME FEEL									
CODICE/CODE	FINITURA/FINISHING	Q. KIT	Q. MIN/PACK				KG. x1/WT.x1	VOL. x1/UNIT VOL.	
137015-061	■ BLU/BLUE RAL5014	x1	10	telaio in tondino/wire frame			0,07	mc. 0,001	
137007-061	■ ARANCIO/ORANGE RAL2003	x1	10	telaio in tondino/wire frame			0,07	mc. 0,001	
137003-061	■ NERO/BLACK RAL9005	x1	10	telaio in tondino/wire frame			0,07	mc. 0,001	
137016-061	■ VERDE/GREEN PANTONE 7495EL	x1	10	telaio in tondino/wire frame			0,07	mc. 0,001	
137005-061	□ BIANCO/WHITE 218	x1	10	telaio in tondino/wire frame			0,07	mc. 0,001	
137004-061	■ GRIGIO/GREY RAL7003	x1	10	telaio in tondino/wire frame			0,07	mc. 0,001	
137007-058	■ SABBIA/SAND RAL1019	x1	10	telaio in tondino/wire frame			0,07	mc. 0,001	
137002-061	■ ROSSO/RED RAL527	x1	10	telaio in tondino/wire frame			0,07	mc. 0,001	
137005-063	□ BIANCO/WHITE 218 autoestinguente/fire retardant	x1	10	telaio in tondino/wire frame			0,07	mc. 0,001	
09 FEEL-PANNELLO SEDILE DA TAPPEZZARE FEEL-PANEL BACK FOR UPHOLSTERY									
CODICE/CODE	FINITURA/FINISHING	Q. KIT	Q. MIN/PACK	A	B			KG. x1/WT.x1	VOL. x1/UNIT VOL.
132203-059	■ NERO/BLACK	x1	25	400	440			0,6	mc. 0,003
10 VITE HILO TB+ 5x14 ZINCATA NERA (per fissare pannello sedile) SCREW HILO TB+ 5X14 FOR UPHOLSTERY SEAT PANEL									
CODICE/CODE	FINITURA/FINISHING	Q. KIT							
117803-155	■ NERO/BLACK	x8							
20 FEEL-COPPIA AGGANCI LATERALE IN TONDINO + PLASTICA FEEL-PAIR SIDE WIRE HOOKS + PLASTIC									
CODICE/CODE	FINITURA/FINISHING	Q. KIT				KG. x1/WT.x1	VOL. x1/UNIT VOL.		
113410-056	■ CROMATO/CHROME	x1				0,15	mc. 0,002		

**OPTIONAL 20**  
COPPIA AGGANCI LATERALE  
COUPLE LATERAL HOOK



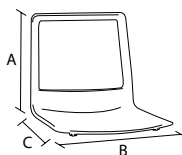
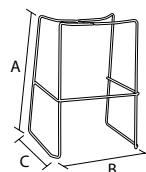
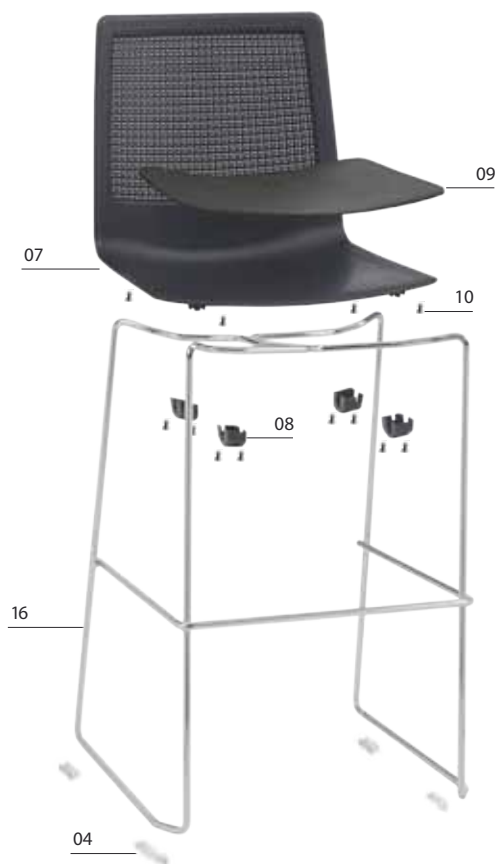

**16 FEEL-SGABELLO ALTO H730 IN TONDINO D.12 PER SCOCCA SENZA TAPPI**  
FEEL-WIRE D.12 HIGH BAR STOOL H730 FOR SHELL FEEL WITHOUT CAPS

CODICE/CODE	FINITURA/FINISHING	Q.KIT	Q.MIN/PACK	A	B	C	KG.x1/WT.x1	VOL.x1/UNIT VOL.
113410-059	■ CROMATO/CHROME	x1	50	730	530	500	6,20	mc. 0,08

**07 FEEL-SCOCCA INTERA MODELLO FEEL**  
FEEL-PLASTIC SHELL MODEL FEEL

CODICE/CODE	FINITURA/FINISHING	Q.KIT	Q.MIN/PACK	A	B	C	KG.x1/WT.x1	VOL.x1/UNIT VOL.
133915-060	■ BLU/BLUE RAL5014	x1	10	420	430	450	1,70	mc. 0,02
133907-060	■ ARANCIO/ORANGE RAL2003	x1	10	420	430	450	1,70	mc. 0,02
133903-060	■ NERO/BLACK RAL9005	x1	10	420	430	450	1,70	mc. 0,02
133916-060	■ VERDE/GREEN PANTONE 7495EL	x1	10	420	430	450	1,70	mc. 0,02
133905-060	□ BIANCO/WHITE 218	x1	10	420	430	450	1,70	mc. 0,02
133904-060	■ GRIGIO/GREY RAL7003	x1	10	420	430	450	1,70	mc. 0,02
133907-059	■ SABBIA/SAND RAL1019	x1	10	420	430	450	1,70	mc. 0,02
133902-060	■ ROSSO/RED RAL527	x1	10	420	430	450	1,70	mc. 0,02
133905-059	□ BIANCO/WHITE 218 autoestinguente/fire retardant	x1	10	420	450	430	1,70	mc. 0,02

**08 FEEL-CONFEZIONE ACCESSORI PER SCOCCA FEEL PER TONDINO**  
FEEL-ACCESSORY PACK FOR WIRE FRAME FEEL

CODICE/CODE	FINITURA/FINISHING	Q.KIT	Q.MIN/PACK	KG.x1/WT.x1	VOL.x1/UNIT VOL.
137015-061	■ BLU/BLUE RAL5014	x1	10	telaio in tondino/wire frame	0,07 mc. 0,001
137007-061	■ ARANCIO/ORANGE RAL2003	x1	10	telaio in tondino/wire frame	0,07 mc. 0,001
137003-061	■ NERO/BLACK RAL9005	x1	10	telaio in tondino/wire frame	0,07 mc. 0,001
137016-061	■ VERDE/GREEN PANTONE 7495EL	x1	10	telaio in tondino/wire frame	0,07 mc. 0,001
137005-061	□ BIANCO/WHITE 218	x1	10	telaio in tondino/wire frame	0,07 mc. 0,001
137004-061	■ GRIGIO/GREY RAL7003	x1	10	telaio in tondino/wire frame	0,07 mc. 0,001
137007-058	■ SABBIA/SAND RAL1019	x1	10	telaio in tondino/wire frame	0,07 mc. 0,001
137002-061	■ ROSSO/RED RAL527	x1	10	telaio in tondino/wire frame	0,07 mc. 0,001
137005-063	□ BIANCO/WHITE 218 autoestinguente/fire retardant	x1	10	telaio in tondino/wire frame	0,07 mc. 0,001

**09 FEEL-PANNELLO SEDILE DA TAPPEZZARE**  
FEEL-PANEL BACK FOR UPHOLSTERY

CODICE/CODE	FINITURA/FINISHING	Q.KIT	Q.MIN/PACK	A	B	KG.x1/WT.x1	VOL.x1/UNIT VOL.
132203-059	■ NERO/BLACK	x1	25	400	440	0,6	mc. 0,003

**10 VITE HILO TB+ 5x14 ZINCATA NERA (per fissare pannello sedile)**  
SCREW HILO TB+ 5X14 FOR UPHOLSTERY SEAT PANEL

CODICE/CODE	FINITURA/FINISHING	Q.KIT
117803-155	■ NERO/BLACK	x8

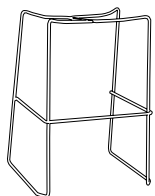
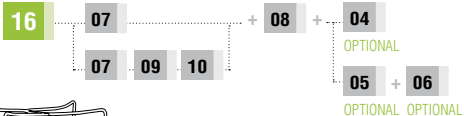

**OPTIONAL 04**  
BTF-KIT PIEDINI  
BTF-KIT FEET



**OPTIONAL 05**  
BTFA-KIT PIEDINI CON GANCI  
BTFA-KIT FEET WITH HOOKS



**OPTIONAL 06**  
PPTF-TAPPO PER FISSAGGIO PAVIMENTO  
PPTF-CAP FOR FIXING TO THE FLOOR



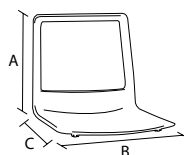
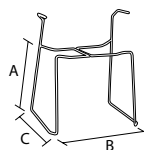
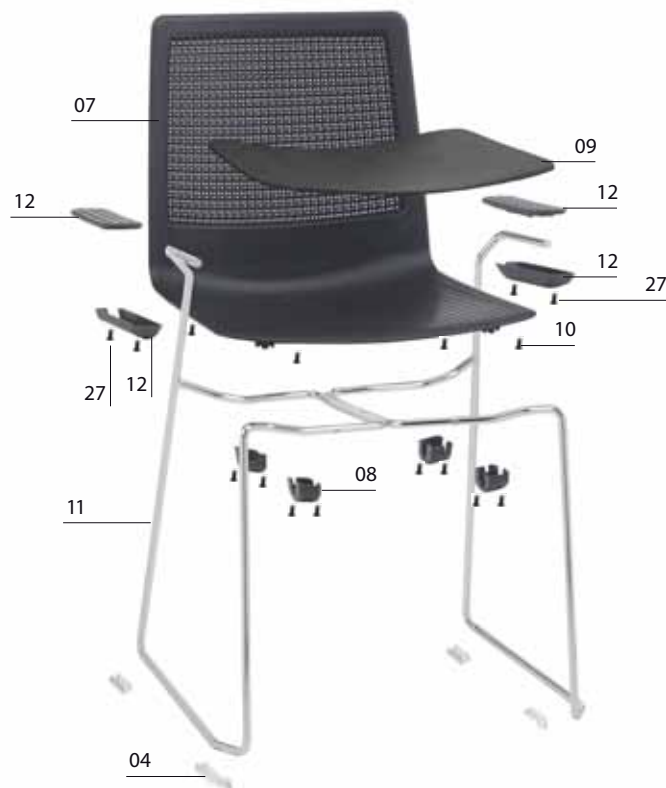

14  
FEEL

**11 FEEL-TELAIO A SLITTA IN TONDINO D.12 CON BRACCIOLI**  
FEEL-SLIDE WIRE FRAME D.12 WITH ARMS

CODICE/CODE	FINITURA/FINISHING	Q.KIT	Q.MIN/PACK	A	B	C	KG.x1/WT.x1	VOL.x1/UNIT VOL.
113410-058	■ CROMATO/CHROME	x1	60	460	530	470	4,50	mc. 0,035

**04 BTF-KIT PIEDINI**  
BTF-KIT FEET

CODICE/CODE	FINITURA/FINISHING	Q.KIT	Q.MIN/PACK	KG.x1/WT.x1
134306-001	□ NEUTRO/NEUTRAL	x1	100	0,05

**05 BTFA-KIT PIEDINI CON GANCI**  
BTFA-KIT FEET WITH HOOKS

CODICE/CODE	FINITURA/FINISHING	Q.KIT	Q.MIN/PACK	KG.x1/WT.x1
134306-002	□ NEUTRO/NEUTRAL	x1	100	0,06

**06 PPTF-TAPPO PER FISSAGGIO PAVIMENTO**  
PPTF-CAP FOR FIXING TO THE FLOOR

CODICE/CODE	FINITURA/FINISHING	Q.KIT	Q.MIN/PACK	KG.x1/WT.x1
134306-003	□ NEUTRO/NEUTRAL	x2	100	0,03

**07 FEEL-SCOCCA INTERA MODELLO FEEL**  
FEEL-PLASTIC SHELL MODEL FEEL

CODICE/CODE	FINITURA/FINISHING	Q.KIT	Q.MIN/PACK	A	B	C	KG.x1/WT.x1	VOL.x1/UNIT VOL.	
133915-060	■ BLU/BLUE	RAL5014	x1	10	420	450	430	1,70	mc. 0,02
133907-060	■ ARANCIO/ORANGE	RAL2003	x1	10	420	450	430	1,70	mc. 0,02
133903-060	■ NERO/BLACK	RAL9005	x1	10	420	450	430	1,70	mc. 0,02
133916-060	■ VERDE/GREEN	PANTONE 7495EL	x1	10	420	450	430	1,70	mc. 0,02
133905-060	□ BIANCO/WHITE	218	x1	10	420	450	430	1,70	mc. 0,02
133904-060	■ GRIGIO/GREY	RAL7003	x1	10	420	450	430	1,70	mc. 0,02
133907-059	■ SABBIA/SAND	RAL1019	x1	10	420	450	430	1,70	mc. 0,02
133902-060	■ ROSSO/RED	RAL527	x1	10	420	450	430	1,70	mc. 0,02
133905-059	□ BIANCO/WHITE 218	autoestinguente/fire retardant	x1	10	420	450	430	1,70	mc. 0,02

**08 FEEL-CONFEZIONE ACCESSORI PER SCOCCA FEEL PER TONDINO**  
FEEL-ACCESSORY PACK FOR WIRE FRAME FEEL

CODICE/CODE	FINITURA/FINISHING	Q.KIT	Q.MIN/PACK	KG.x1/WT.x1	VOL.x1/UNIT VOL.		
137015-061	■ BLU/BLUE	RAL5014	x1	10	telaio in tondino/wire frame	0,07	mc. 0,001
137007-061	■ ARANCIO/ORANGE	RAL2003	x1	10	telaio in tondino/wire frame	0,07	mc. 0,001
137003-061	■ NERO/BLACK	RAL9005	x1	10	telaio in tondino/wire frame	0,07	mc. 0,001
137016-061	■ VERDE/GREEN	PANTONE 7495EL	x1	10	telaio in tondino/wire frame	0,07	mc. 0,001
137005-061	□ BIANCO/WHITE	218	x1	10	telaio in tondino/wire frame	0,07	mc. 0,001
137004-061	■ GRIGIO/GREY	RAL7003	x1	10	telaio in tondino/wire frame	0,07	mc. 0,001
137007-058	■ SABBIA/SAND	RAL1019	x1	10	telaio in tondino/wire frame	0,07	mc. 0,001
137002-061	■ ROSSO/RED	RAL527	x1	10	telaio in tondino/wire frame	0,07	mc. 0,001
137005-063	□ BIANCO/WHITE 218	autoestinguente/fire retardant	x1	10	telaio in tondino/wire frame	0,07	mc. 0,001



**OPTIONAL 04**  
BTF-KIT PIEDINI  
BTF-KIT FEET



**OPTIONAL 05**  
BTFA-KIT PIEDINI CON GANCI  
BTFA-KIT FEET WITH HOOKS



**OPTIONAL 06**  
PPTF-TAPPO PER FISSAGGIO PAVIMENTO  
PPTF-CAP FOR FIXING TO THE FLOOR



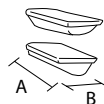

**09 FEEL-PANNELLO SEDILE DA TAPPEZZARE**  
FEEL-PANEL BACK FOR UPHOLSTERY

CODICE/CODE	FINITURA/FINISHING	Q. KIT	Q. MIN/PACK	A	B	KG. x1/WT.x1	VOL. x1/UNIT VOL.
132203-059	■ NERO/BLACK	x1	25	400	440	0,6	mc. 0,003

**10 VITE HILO TB+ 5x14 ZINCATA NERA (per fissare pannello sedile)**  
SCREW HILO TB+ 5X14 FOR UPHOLSTERY SEAT PANEL

CODICE/CODE	FINITURA/FINISHING	Q. KIT
117803-155	■ NERO/BLACK	x8

**12 FEEL-COPPIA BRACCIOLI IN PLASTICA COLORATA PER SLITTA**  
FEEL-PAIR COLORED PLASTIC ARM FOR WIRE FRAME

CODICE/CODE	FINITURA/FINISHING	Q. KIT	Q. MIN/PACK		A	B	KG. x1/WT.x1	VOL. x1/UNIT VOL.
131715-057	■ BLU/BLUE RAL5014	x1	20	right + left	200	30	0,16	mc. 0,0045
131707-056	■ ARANCIO/ORANGE RAL2003	x1	20	right + left	200	30	0,16	mc. 0,0045
131703-057	■ NERO/BLACK RAL9005	x1	20	right + left	200	30	0,16	mc. 0,0045
131716-057	■ VERDE/GREEN PANTONE 7495EL	x1	20	right + left	200	30	0,16	mc. 0,0045
131705-057	□ BIANCO/WHITE 218	x1	20	right + left	200	30	0,16	mc. 0,0045
131704-057	■ GRIGIO/GREY RAL7003	x1	20	right + left	200	30	0,16	mc. 0,0045
131707-053	■ SABBIA/SAND RAL1019	x1	20	right + left	200	30	0,16	mc. 0,0045
131702-057	■ ROSSO/RED RAL527	x1	20	right + left	200	30	0,16	mc. 0,0045
131705-157	■ BIANCO/WHITE 218 autoestinguente/fire retardant	x1	20	right + left	200	30	0,16	mc. 0,0045

**27 VITE HILO TB+ 5x14 ZINCATA NERA (per fissare bracciolo)**  
SCREW HILO TB+ 5X14 FOR ARM

CODICE/CODE	FINITURA/FINISHING	Q. KIT
117803-155	■ NERO/BLACK	x4

**FEEL-CARRELLO PORTASEDIE CON ACCESSORI NERO**  
FEEL-TROLLEY FOR CHAIRS WITH ACCESSORIES BLACK

CODICE/CODE	FINITURA/FINISHING	Q. KIT
110803-053	■ NERO/BLACK	x1

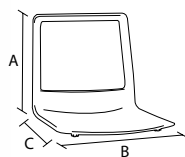
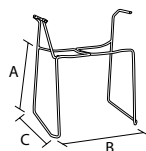

16  
FEEL

### 13 FEEL-TELAIO A SLITTA IN TONDINO D.12 CON BRACCIOLI E PORTATAVOLETTA

CODICE/CODE	FINITURA/FINISHING	Q.KIT	Q.MIN/PACK	A	B	C	KG.x1/WT.x1	VOL.x1/UNIT VOL.
113410-072	■ CROMATO/CHROME right writing tablet hook	x1	30	460	530	470	5,00	mc. 0,07
113410-073	■ CROMATO/CHROME left writing tablet hook	x1	30	460	530	470	5,00	mc. 0,07

### 04 BTF-KIT PIEDINI

CODICE/CODE	FINITURA/FINISHING	Q.KIT	Q.MIN/PACK	KG.x1/WT.x1
134306-001	□ NEUTRO/NEUTRAL	x1	100	0,05

### 05 BTFA-KIT PIEDINI CON GANCI

CODICE/CODE	FINITURA/FINISHING	Q.KIT	Q.MIN/PACK	KG.x1/WT.x1
134306-002	□ NEUTRO/NEUTRAL	x1	100	0,06

### 06 PPTF-TAPPO PER FISSAGGIO PAVIMENTO

CODICE/CODE	FINITURA/FINISHING	Q.KIT	Q.MIN/PACK	KG.x1/WT.x1
134306-003	□ NEUTRO/NEUTRAL	x2	100	0,03

### 07 FEEL-SCOCOA INTERA MODELLO FEEL

CODICE/CODE	FINITURA/FINISHING	Q.KIT	Q.MIN/PACK	A	B	C	KG.x1/WT.x1	VOL.x1/UNIT VOL.
133915-060	■ BLU/BLUE RAL5014	x1	10	420	450	430	1,70	mc. 0,02
133907-060	■ ARANCIO/ORANGE RAL2003	x1	10	420	450	430	1,70	mc. 0,02
133903-060	■ NERO/BLACK RAL9005	x1	10	420	450	430	1,70	mc. 0,02
133916-060	■ VERDE/GREEN PANTONE 7495EL	x1	10	420	450	430	1,70	mc. 0,02
133905-060	□ BIANCO/WHITE 218	x1	10	420	450	430	1,70	mc. 0,02
133904-060	■ GRIGIO/GREY RAL7003	x1	10	420	450	430	1,70	mc. 0,02
133907-059	■ SABBIA/SAND RAL1019	x1	10	420	450	430	1,70	mc. 0,02
133902-060	■ ROSSO/RED RAL527	x1	10	420	450	430	1,70	mc. 0,02
133905-059	□ BIANCO/WHITE 218 autoestinguente/fire retardant	x1	10	420	450	430	1,70	mc. 0,02

### 08 FEEL-CONFEZIONE ACCESSORI PER SCOCOA FEEL PER TONDINO

CODICE/CODE	FINITURA/FINISHING	Q.KIT	Q.MIN/PACK	KG.x1/WT.x1	VOL.x1/UNIT VOL.
137015-061	■ BLU/BLUE RAL5014	x1	10	telaio in tondino/wire frame	0,07 mc. 0,001
137007-061	■ ARANCIO/ORANGE RAL2003	x1	10	telaio in tondino/wire frame	0,07 mc. 0,001
137003-061	■ NERO/BLACK RAL9005	x1	10	telaio in tondino/wire frame	0,07 mc. 0,001
137016-061	■ VERDE/GREEN PANTONE 7495EL	x1	10	telaio in tondino/wire frame	0,07 mc. 0,001
137005-061	□ BIANCO/WHITE 218	x1	10	telaio in tondino/wire frame	0,07 mc. 0,001
137004-061	■ GRIGIO/GREY RAL7003	x1	10	telaio in tondino/wire frame	0,07 mc. 0,001
137007-058	■ SABBIA/SAND RAL1019	x1	10	telaio in tondino/wire frame	0,07 mc. 0,001
137002-061	■ ROSSO/RED RAL527	x1	10	telaio in tondino/wire frame	0,07 mc. 0,001
137005-063	□ BIANCO/WHITE 218 autoestinguente/fire retardant	x1	10	telaio in tondino/wire frame	0,07 mc. 0,001

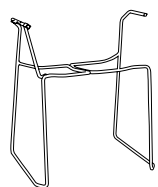

#### OPTIONAL 04

BTF-KIT PIEDINI  
BTF-KIT FEET



#### OPTIONAL 05

BTFA-KIT PIEDINI CON GANCI  
BTFA-KIT FEET WITH HOOKS



#### OPTIONAL 06

PPTF-TAPPO PER FISSAGGIO PAVIMENTO  
PPTF-CAP FOR FIXING TO THE FLOOR



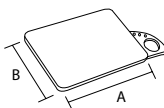
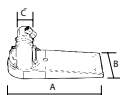
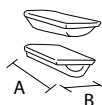
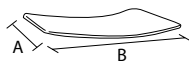

**09 FEEL-PANNELLO SEDILE DA TAPPEZZARE**  
FEEL-PANEL BACK FOR UPHOLSTERY

CODICE/CODE	FINITURA/FINISHING	Q. KIT	Q. MIN/PACK	A	B	KG.x1/WT.x1	VOL.x1/UNIT VOL.
132203-059	■ NERO/BLACK	x1	25	400	440	0,6	mc. 0,003

**10 VITE HILO TB+ 5x14 ZINCATA NERA (per fissare pannello sedile)**  
SCREW HILO TB+ 5X14 FOR UPHOLSTERY SEAT PANEL

CODICE/CODE	FINITURA/FINISHING	Q. KIT
117803-155	■ NERO/BLACK	x8

**28 FEEL-COPPIA BRACCIOLI IN PLASTICA COLORATA PER SLITTA CON TAVOLETTA**  
FEEL-PAIR COLORED PLASTIC ARM FOR WIRE FRAME WITH TABLET

CODICE/CODE	FINITURA/FINISHING	Q. KIT	Q. MIN/PACK		A	B	KG.x1/WT.x1	VOL.x1/UNIT VOL.	
131715-058	■ BLU/BLUE	RAL5014	x1	20	right + left for tablet	200	30	0,16	mc. 0,0045
131715-059	■ BLU/BLUE	RAL5014	x1	20	left + right for tablet	200	30	0,16	mc. 0,0045
131707-057	■ ARANCIO/ORANGE	RAL2003	x1	20	right + left for tablet	200	30	0,16	mc. 0,0045
131707-058	■ ARANCIO/ORANGE	RAL2003	x1	20	left + right for tablet	200	30	0,16	mc. 0,0045
131703-058	■ NERO/BLACK	RAL9005	x1	20	right + left for tablet	200	30	0,16	mc. 0,0045
131703-059	■ NERO/BLACK	RAL9005	x1	20	left + right for tablet	200	30	0,16	mc. 0,0045
131716-058	■ VERDE/GREEN	PANTONE 7495EL	x1	20	right + left for tablet	200	30	0,16	mc. 0,0045
131716-059	■ VERDE/GREEN	PANTONE 7495EL	x1	20	left + right for tablet	200	30	0,16	mc. 0,0045
131705-058	□ BIANCO/WHITE	218	x1	20	right + left for tablet	200	30	0,16	mc. 0,0045
131705-059	□ BIANCO/WHITE	218	x1	20	left + right for tablet	200	30	0,16	mc. 0,0045
131704-058	■ GRIGIO/GREY	RAL7003	x1	20	right + left for tablet	200	30	0,16	mc. 0,0045
131704-059	■ GRIGIO/GREY	RAL7003	x1	20	left + right for tablet	200	30	0,16	mc. 0,0045
131707-054	■ SABBIA/SAND	RAL1019	x1	20	right + left for tablet	200	30	0,16	mc. 0,0045
131707-055	■ SABBIA/SAND	RAL1019	x1	20	left + right for tablet	200	30	0,16	mc. 0,0045
131702-058	■ ROSSO/RED	RAL527	x1	20	right + left for tablet	200	30	0,16	mc. 0,0045
131702-059	■ ROSSO/RED	RAL527	x1	20	left + right for tablet	200	30	0,16	mc. 0,0045
131705-158	□ BIANCO/WHITE 218	autoestinguente/fire retardant	x1	20	right + left for tablet	200	30	0,16	mc. 0,0045
131705-159	□ BIANCO/WHITE 218	autoestinguente/fire retardant	x1	20	left + right for tablet	200	30	0,16	mc. 0,0045

**14 SPT2-SNODO PER TAVOLETTA IN TERMOPLASTICA**  
SPT2-THERMOPLASTIC WRITING TABLET ARTICULATION

CODICE/CODE	FINITURA/FINISHING	Q. KIT	Q. MIN/PACK	A	B	C	KG.x1/WT.x1	VOL.x1/UNIT VOL.
134003-039	■ NERO/BLACK	x1	20	180	66	15x15	0,35	mc. 0,0006

**15 TLT3-TAVOLETTA AMBIDESTRO CON PORTABICCHIERE E PORTAPENNE**  
TLT3-WRITING TABLET WITH CUP HOLDER AND PEN TRAY

CODICE/CODE	FINITURA/FINISHING	Q. KIT	Q. MIN/PACK	A	B	KG.x1/WT.x1	VOL.x1/UNIT VOL.
134003-041	■ NERO/BLACK	x1	10	410	300	1,05	mc. 0,036

**27 VITE HILO TB+ 5x14 ZINCATA NERA (per fissare bracciolo)**  
SCREW HILO TB+ 5X14 FOR ARM

CODICE/CODE	FINITURA/FINISHING	Q. KIT
117803-155	■ NERO/BLACK	x4

**OPTIONAL**

**TAVOLETTA TLT**  
TLT TABLET



VEDI/SEE PAG. 321

**TAVOLETTA TLT2**  
TLT2 TABLET



VEDI/SEE PAG. 321

**TAVOLETTA TLT3**  
TLT3 TABLET



VEDI/SEE PAG. 321

**TAVOLETTA BEAN**  
BEAN TABLET



VEDI/SEE PAG. 321

**TAVOLETTA TL01**  
TL01 TABLET



VEDI/SEE PAG. 321

**SNODO TAVOLETTA SPT2**  
SPT2 MECHANISM TABLET



VEDI/SEE PAG. 320

**SNODO ANTIPANICO**  
MECHANISM ANTIPANICO



VEDI/SEE PAG. 320



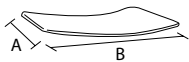
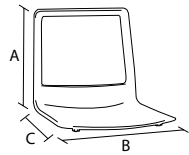
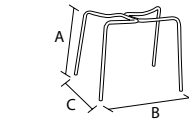
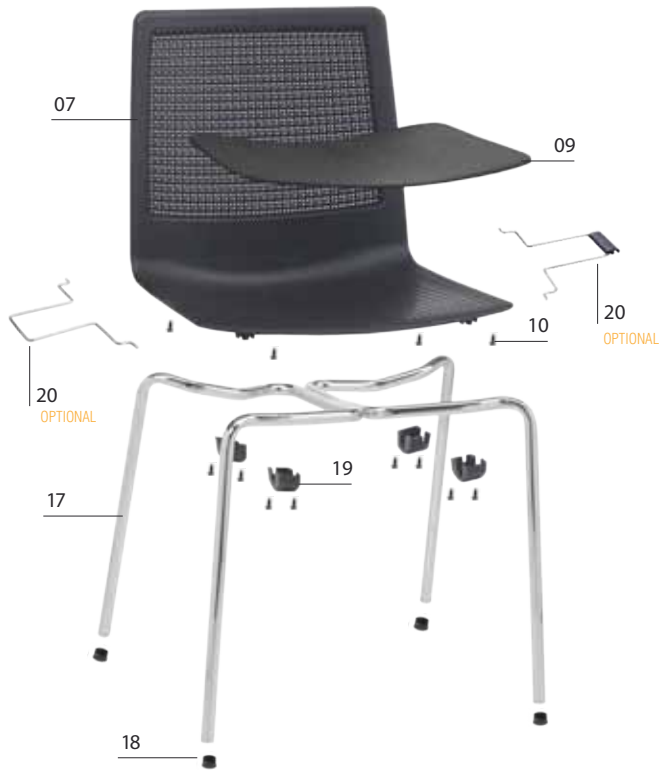

## 17 FEEL-TELAIO 4 GAMBE IN TUBO D.18 SENZA TAPPI

FEEL-4 LEGS FRAMES D.18 WITHOUT CAPS										
CODICE/CODE	FINITURA/FINISHING		Q.KIT	Q.MIN/PACK	A	B	C	KG.x1/WT.x1	VOL.x1/UNIT VOL.	
112703-031	■ NERO/BLACK	RAL9005	x1	200	440	510	500	2	mc. 0,025	
112704-031	■ GRIGIO/GREY	RAL7003	x1	60	440	510	500	2	mc. 0,025	
112705-031	□ BIANCO/WHITE	RAL9003	x1	60	440	510	500	2	mc. 0,025	
112710-031	■ CROMATO/CHROME		x1	200	440	510	500	2	mc. 0,025	
112703-032*	■ NERO/BLACK	RAL9005	*per esterno/outdoor	x1	440	510	500	2	mc. 0,025	
112704-032*	■ GRIGIO/GREY	RAL7003	*per esterno/outdoor	x1	440	510	500	2	mc. 0,025	
112705-032*	□ BIANCO/WHITE	RAL9003	*per esterno/outdoor	x1	440	510	500	2	mc. 0,025	

## 18 CONFEZIONE PUNTALI TONDI D.18 NERI

BLACK INNER ROUND CAPS D.18 PACKAGE				
CODICE/CODE	FINITURA/FINISHING	Q.KIT	Q.MIN/PACK	
137003-072	■ NERO/BLACK	x4	200	
134205-181	□ BIANCO/WHITE	x4		

## 07 FEEL-SCocca INTERNA MODELLO FEEL

FEEL-PLASTIC SHELL MODEL FEEL									
CODICE/CODE	FINITURA/FINISHING		Q.KIT	Q.MIN/PACK	A	B	C	KG.x1/WT.x1	VOL.x1/UNIT VOL.
133915-060	■ BLU/BLUE	RAL5014	x1	10	420	450	430	1,70	mc. 0,02
133907-060	■ ARANCIO/ORANGE	RAL2003	x1	10	420	450	430	1,70	mc. 0,02
133903-060	■ NERO/BLACK	RAL9005	x1	10	420	450	430	1,70	mc. 0,02
133916-060	■ VERDE/GREEN	PANTONE 7495EL	x1	10	420	450	430	1,70	mc. 0,02
133905-060	□ BIANCO/WHITE	218	x1	10	420	450	430	1,70	mc. 0,02
133904-060	■ GRIGIO/GREY	RAL7003	x1	10	420	450	430	1,70	mc. 0,02
133907-059	■ SABBIA/SAND	RAL1019	x1	10	420	450	430	1,70	mc. 0,02
133902-060	■ ROSSO/RED	RAL527	x1	10	420	450	430	1,70	mc. 0,02
133905-059	□ BIANCO/WHITE 218	autoestinguente/fire retardant	x1	10	420	450	430	1,70	mc. 0,02

## 19 FEEL-CONFEZIONE ACCESSORI PER SCocca FEEL PER TUBO D.18

FEEL-ACCESSORY PACK FOR SHELL FEEL FOR TUBE D.18									
CODICE/CODE	FINITURA/FINISHING		Q.KIT	Q.MIN/PACK				KG.x1/WT.x1	VOL.x1/UNIT VOL.
137015-060	■ BLU/BLUE	RAL5014	x1	10	telaio tubo/tube frame			0,07	mc. 0,001
137007-060	■ ARANCIO/ORANGE	RAL2003	x1	10	telaio tubo/tube frame			0,07	mc. 0,001
137003-060	■ NERO/BLACK	RAL9005	x1	10	telaio tubo/tube frame			0,07	mc. 0,001
137016-060	■ VERDE/GREEN	PANTONE 7495EL	x1	10	telaio tubo/tube frame			0,07	mc. 0,001
137005-060	□ BIANCO/WHITE	218	x1	10	telaio tubo/tube frame			0,07	mc. 0,001
137004-060	■ GRIGIO/GREY	RAL7003	x1	10	telaio tubo/tube frame			0,07	mc. 0,001
137007-059	■ SABBIA/SAND	RAL1019	x1	10	telaio tubo/tube frame			0,07	mc. 0,001
137002-060	■ ROSSO/RED	RAL527	x1	10	telaio tubo/tube frame			0,07	mc. 0,001
137005-062	□ BIANCO/WHITE 218	autoestinguente/fire retardant	x1	10	telaio tubo/tube frame			0,07	mc. 0,001

## 09 FEEL-PANNELLO SEDILE DA TAPPEZZARE

FEEL-PANEL BACK FOR UPHOLSTERY									
CODICE/CODE	FINITURA/FINISHING	Q.KIT	Q.MIN/PACK	A	B	KG.x1/WT.x1	VOL.x1/UNIT VOL.		
132203-059	■ NERO/BLACK	x1	25	400	440	0,6	mc. 0,003		

## 10 VITE HILO TB+ 5x14 ZINCATA NERA (per fissare pannello sedile)

SCREW HILO TB+ 5X14 FOR UPHOLSTERY SEAT PANEL			
CODICE/CODE	FINITURA/FINISHING	Q.KIT	
117803-155	■ NERO/BLACK	x8	

## 20 FEEL-COPPIA AGGANCI LATERALE IN TONDINO + PLASTICA

FEEL-PAIR SIDE WIRE HOOKS + PLASTIC					
CODICE/CODE	FINITURA/FINISHING	Q.KIT	KG.x1/WT.x1	VOL.x1/UNIT VOL.	
113410-056	■ CROMATO/CHROME	x1	0,15	mc. 0,002	



### OPTIONAL 20

COPPIA AGGANCI LATERALE  
COUPLE LATERAL HOOK





## 21 FEEL-TELAIO 4 GAMBE D.18 CON BRACCIOLI SENZA TAPPI

FEEL-4 LEGS FRAME D.18 WITH ARM AND WITHOUT CAPS

CODICE/CODE	FINITURA/FINISHING	Q. KIT	Q. MIN/PACK	A	B	C	KG. x1/WT.x1	VOL. x1/UNIT VOL.
112703-033	■ NERO/BLACK	x1	60	440	510	500	2,6	mc. 0,035
112704-033	■ GRIGIO/GREY RAL7003	x1	60	440	510	500	2,6	mc. 0,035
112705-033	□ BIANCO/WHITE RAL9003	x1	60	440	510	500	2,6	mc. 0,035
112710-033	■ CROMATO/CHROME	x1	60	440	510	500	2,6	mc. 0,035
112703-034*	■ NERO/BLACK	x1	60	440	510	500	2,6	mc. 0,035
112704-034*	■ GRIGIO/GREY RAL7003	x1	60	440	510	500	2,6	mc. 0,035
112705-034*	□ BIANCO/WHITE RAL9003	x1	60	440	510	500	2,6	mc. 0,035

## 22 FEEL-COPPIA BRACCIOLI IN PLASTICA COLORATA PER 4 GAMBE

FEEL-PAIR COLORED PLASTIC ARM FOR 4 LEGS FRAME

CODICE/CODE	FINITURA/FINISHING	Q. KIT	Q. MIN/PACK	A	B	KG. x1/WT.x1	VOL. x1/UNIT VOL.	
131715-062	■ BLU/BLUE RAL5014	x1	20	right + left	200	30	0,16	mc. 0,001
131707-062	■ ARANCIO/ORANGE RAL2003	x1	20	right + left	200	30	0,16	mc. 0,001
131703-062	■ NERO/BLACK RAL9005	x1	20	right + left	200	30	0,16	mc. 0,001
131716-062	■ VERDE/GREEN PANTONE 7495EL	x1	20	right + left	200	30	0,16	mc. 0,001
131705-062	□ BIANCO/WHITE 218	x1	20	right + left	200	30	0,16	mc. 0,001
131704-062	■ GRIGIO/GREY RAL7003	x1	20	right + left	200	30	0,16	mc. 0,001
131707-059	■ SABBIA/SAND RAL1019	x1	20	right + left	200	30	0,16	mc. 0,001
131702-062	■ ROSSO/RED RAL527	x1	20	right + left	200	30	0,16	mc. 0,001
131705-162	□ BIANCO/WHITE 218 autoestinguente/fire retardant	x1	20	right + left	200	30	0,16	mc. 0,001

## 27 VITE HILO TB+ 5x14 ZINCATA NERA (per fissare bracciolo)

SCREW HILO TB+ 5X14 FOR ARM

CODICE/CODE	FINITURA/FINISHING	Q. KIT
117803-155	■ NERO/BLACK	x4



# FEEL 4 LEGS

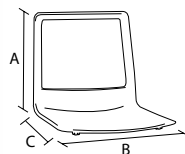
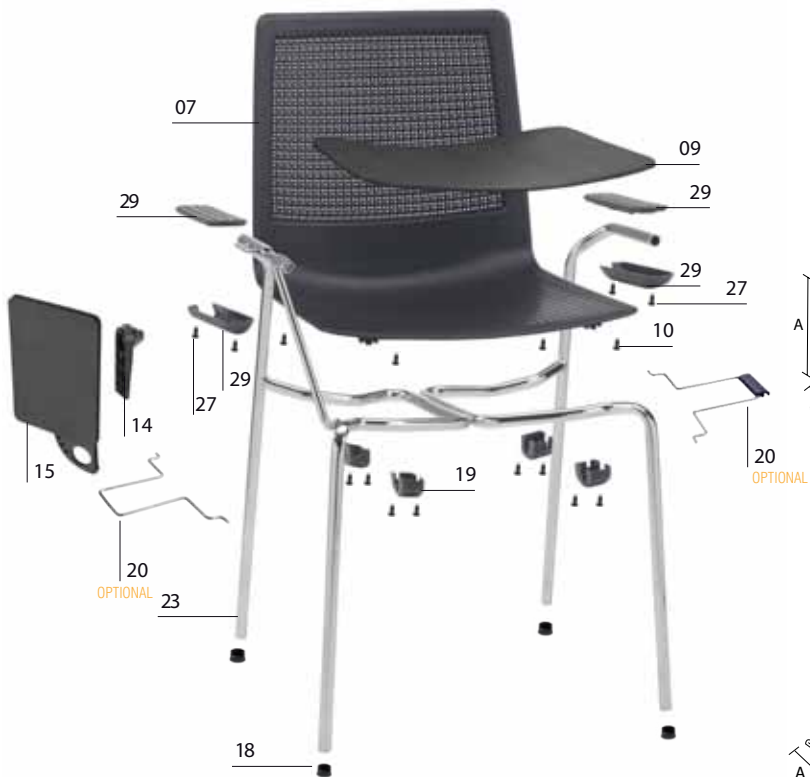
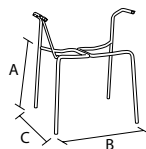

FEEL



## 23 FEEL-TELAIO 4 GAMBE IN TUBO D.18 SENZA TAPPI CON BRACCIOLI E PORTATAVOLETTA

FEEL-4 LEGS FRAMES D.18 WITHOUT CAPS WITH ARMRESTS AND WRITING TABLET HOOK

CODICE/CODE	FINITURA/FINISHING	Q.KIT	Q.MIN/PACK	A	B	C	KG.x1/WT.x1	VOL.x1/UNIT VOL.
112703-037	■ NERO/BLACK	RAL9005 right writing tab. hook	x1	30	440	510	500	3,50 mc. 0,07
112704-037	■ GRIGIO/GREY	RAL7003 right writing tab. hook	x1	30	440	510	500	3,50 mc. 0,07
112705-037	□ BIANCO/WHITE	RAL9003 right writing tab. hook	x1	30	440	510	500	3,50 mc. 0,07
112710-037	■ CROMATO/CHROME	right writing tab. hook	x1	30	440	510	500	3,50 mc. 0,07
112703-038	■ NERO/BLACK	RAL9005 left writing tab. hook	x1	30	440	510	500	3,50 mc. 0,07
112704-038	■ GRIGIO/GREY	RAL7003 left writing tab. hook	x1	30	440	510	500	3,50 mc. 0,07
112705-038	□ BIANCO/WHITE	RAL9003 left writing tab. hook	x1	30	440	510	500	3,50 mc. 0,07
112710-038	■ CROMATO/CHROME	left writing tab. hook	x1	30	440	510	500	3,50 mc. 0,07

## 18 CONFEZIONE PUNTALI TONDI D.18 NERI

BLACK INNER ROUND CAPS D.18 PACKAGE

CODICE/CODE	FINITURA/FINISHING	Q.KIT	Q.MIN/PACK
137003-072	■ NERO/BLACK	x4	200
134205-181	□ BIANCO/WHITE	x4	

## 07 FEEL-SCOCCA INTERA MODELLO FEEL

FEEL-PLASTIC SHELL MODEL FEEL

CODICE/CODE	FINITURA/FINISHING	Q.KIT	Q.MIN/PACK	A	B	C	KG.x1/WT.x1	VOL.x1/UNIT VOL.
133915-060	■ BLU/BLUE	RAL5014	x1	10	420	450	430	1,70 mc. 0,02
133907-060	■ ARANCIO/ORANGE	RAL2003	x1	10	420	450	430	1,70 mc. 0,02
133903-060	■ NERO/BLACK	RAL9005	x1	10	420	450	430	1,70 mc. 0,02
133916-060	■ VERDE/GREEN	PANTONE 7495EL	x1	10	420	450	430	1,70 mc. 0,02
133905-060	□ BIANCO/WHITE	218	x1	10	420	450	430	1,70 mc. 0,02
133904-060	■ GRIGIO/GREY	RAL7003	x1	10	420	450	430	1,70 mc. 0,02
133907-059	■ SABBIA/SAND	RAL1019	x1	10	420	450	430	1,70 mc. 0,02
133902-060	■ ROSSO/RED	RAL527	x1	10	420	450	430	1,70 mc. 0,02
133905-059	□ BIANCO/WHITE 218	autoestinguente/fire retardant	x1	10	420	450	430	1,70 mc. 0,02

## 19 FEEL-CONFEZIONE ACCESSORI PER SCOCCA FEEL PER TUBO D.18

FEEL-ACCESSORY PACK FOR SHELL FEEL FOR TUBE D.18

CODICE/CODE	FINITURA/FINISHING	Q.KIT	Q.MIN/PACK	KG.x1/WT.x1	VOL.x1/UNIT VOL.
137015-060	■ BLU/BLUE	RAL5014	x1	10	telaio tubo/tube frame 0,07 mc. 0,001
137007-060	■ ARANCIO/ORANGE	RAL2003	x1	10	telaio tubo/tube frame 0,07 mc. 0,001
137003-060	■ NERO/BLACK	RAL9005	x1	10	telaio tubo/tube frame 0,07 mc. 0,001
137016-060	■ VERDE/GREEN	PANTONE 7495EL	x1	10	telaio tubo/tube frame 0,07 mc. 0,001
137005-060	□ BIANCO/WHITE	218	x1	10	telaio tubo/tube frame 0,07 mc. 0,001
137004-060	■ GRIGIO/GREY	RAL7003	x1	10	telaio tubo/tube frame 0,07 mc. 0,001
137007-059	■ SABBIA/SAND	RAL1019	x1	10	telaio tubo/tube frame 0,07 mc. 0,001
137002-060	■ ROSSO/RED	RAL527	x1	10	telaio tubo/tube frame 0,07 mc. 0,001
137005-062	□ BIANCO/WHITE 218	autoestinguente/fire retardant	x1	10	telaio tubo/tube frame 0,07 mc. 0,001

## 09 FEEL-PANNELLO SEDILE DA TAPPEZZARE

FEEL-PANEL BACK FOR UPHOLSTERY

CODICE/CODE	FINITURA/FINISHING	Q.KIT	Q.MIN/PACK	A	B	KG.x1/WT.x1	VOL.x1/UNIT VOL.
132203-059	■ NERO/BLACK	x1	25	400	440	0,6	mc. 0,003

## 10 VITE HILO TB+ 5x14 ZINCATO NERA (per fissare pannello sedile)

SCREW HILO TB+ 5X14 FOR UPHOLSTERY SEAT PANEL

CODICE/CODE	FINITURA/FINISHING	Q.KIT
117803-155	■ NERO/BLACK	x8

## 20 FEEL-COPPIA AGGANCI LATERALE IN TONDINO + PLASTICA

FEEL-PAIR SIDE WIRE HOOKS + PLASTIC

CODICE/CODE	FINITURA/FINISHING	Q.KIT	KG.x1/WT.x1	VOL.x1/UNIT VOL.
113410-056	■ CROMATO/CHROME	x1	0,15	mc. 0,002

### OPTIONAL 20

COPPIA AGGANCI LATERALE  
COUPLE LATERAL HOOK





**29 FEEL-COPPIA BRACCIOLI IN PLASTICA COLORATA PER 4 GAMBE CON TAVOLETTA**  
FEEL-PAIR COLORED PLASTIC ARM FOR 4 LEGS FRAME WITH TABLET

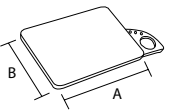
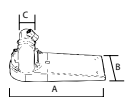
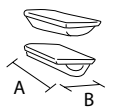

CODICE/CODE	FINITURA/FINISHING	Q. KIT	Q. MIN/PACK	A	B	KG. x1/WT.x1	VOL. x1/UNIT VOL.
131715-063	■ BLU/BLUE RAL5014	x1	20	right + left for tablet	200 30	0,16	mc. 0,001
131715-064	■ BLU/BLUE RAL5014	x1	20	left + right for tablet	200 30	0,16	mc. 0,001
131707-063	■ ARANCIO/ORANGE RAL2003	x1	20	right + left for tablet	200 30	0,16	mc. 0,001
131707-064	■ ARANCIO/ORANGE RAL2003	x1	20	left + right for tablet	200 30	0,16	mc. 0,001
131703-063	■ NERO/BLACK RAL9005	x1	20	right + left for tablet	200 30	0,16	mc. 0,001
131703-064	■ NERO/BLACK RAL9005	x1	20	left + right for tablet	200 30	0,16	mc. 0,001
131716-063	■ VERDE/GREEN PANTONE 7495EL	x1	20	right + left for tablet	200 30	0,16	mc. 0,001
131716-064	■ VERDE/GREEN PANTONE 7495EL	x1	20	left + right for tablet	200 30	0,16	mc. 0,001
131705-063	□ BIANCO/WHITE 218	x1	20	right + left for tablet	200 30	0,16	mc. 0,001
131705-064	□ BIANCO/WHITE 218	x1	20	left + right for tablet	200 30	0,16	mc. 0,001
131704-063	■ GRIGIO/GREY RAL7003	x1	20	right + left for tablet	200 30	0,16	mc. 0,001
131704-064	■ GRIGIO/GREY RAL7003	x1	20	left + right for tablet	200 30	0,16	mc. 0,001
131707-060	■ SABBIA/SAND RAL1019	x1	20	right + left for tablet	200 30	0,16	mc. 0,001
131707-061	■ SABBIA/SAND RAL1019	x1	20	left + right for tablet	200 30	0,16	mc. 0,001
131702-063	■ ROSSO/RED RAL527	x1	20	right + left for tablet	200 30	0,16	mc. 0,001
131702-064	■ ROSSO/RED RAL527	x1	20	left + right for tablet	200 30	0,16	mc. 0,001
131705-163	□ BIANCO/WHITE 218 autoestinguente/fire retardant	x1	20	right + left for tablet	200 30	0,16	mc. 0,001
131705-164	□ BIANCO/WHITE 218 autoestinguente/fire retardant	x1	20	left + right for tablet	200 30	0,16	mc. 0,001

**14 SPT2-SNODO PER TAVOLETTA IN TERMOPLASTICA**  
SPT2-THERMOPLASTIC WRITING TABLET ARTICULATION

CODICE/CODE	FINITURA/FINISHING	Q. KIT	Q. MIN/PACK	A	B	C	KG. x1/WT.x1	VOL. x1/UNIT VOL.
134003-039	■ NERO/BLACK	x1	20	180	66	15x15	0,35	mc. 0,0006

**15 TLT3-TAVOLETTA AMBIDESTRO CON PORTABICCHIERE E PORTAPENNE**  
TLT3--WRITING TABLET WITH CUP HOLDER AND PEN TRAY

CODICE/CODE	FINITURA/FINISHING	Q. KIT	Q. MIN/PACK	A	B	KG. x1/WT.x1	VOL. x1/UNIT VOL.	
134003-041	■ NERO/BLACK	x1	10	410	300		1,05	mc. 0,036

**27 VITE HILO TB+ 5x14 ZINCATA NERA (per fissare bracciolo)**  
SCREW HILO TB+ 5X14 FOR ARM

CODICE/CODE	FINITURA/FINISHING	Q. KIT
117803-155	■ NERO/BLACK	x4

**OPTIONAL**

<p><b>TAVOLETTA TLT</b> TLT TABLET</p>  <p>VEDI/SEE PAG. 321</p>	<p><b>TAVOLETTA TLT2</b> TLT2 TABLET</p>  <p>VEDI/SEE PAG. 321</p>	<p><b>TAVOLETTA TLT3</b> TLT3 TABLET</p>  <p>VEDI/SEE PAG. 321</p>	<p><b>TAVOLETTA BEAN</b> BEAN TABLET</p>  <p>VEDI/SEE PAG. 321</p>	<p><b>TAVOLETTA TL01</b> TL01 TABLET</p>  <p>VEDI/SEE PAG. 321</p>	<p><b>SNODO TAVOLETTA SPT2</b> SPT2 MECHANISM TABLET</p>  <p>VEDI/SEE PAG. 320</p>	<p><b>SNODO ANTIPANICO</b> MECHANISM ANTIPANIC</p>  <p>VEDI/SEE PAG. 320</p>
-----------------------------------------------------------------------------------------------------------------------------------------------------------	-------------------------------------------------------------------------------------------------------------------------------------------------------------	-------------------------------------------------------------------------------------------------------------------------------------------------------------	-------------------------------------------------------------------------------------------------------------------------------------------------------------	-------------------------------------------------------------------------------------------------------------------------------------------------------------	-----------------------------------------------------------------------------------------------------------------------------------------------------------------------------	-----------------------------------------------------------------------------------------------------------------------------------------------------------------------

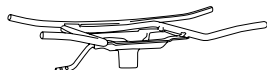
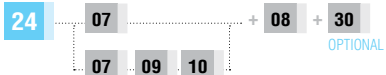
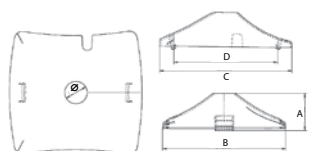
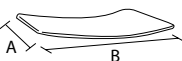
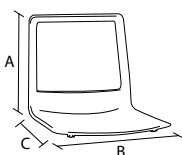

## 24 FEEL-SUPPORTO GIREVOLE A GAS PER SCOCCA FEEL

FEEL-SWIVEL FRAME FOR FEEL SHELL		Q.KIT	Q.MIN/PACK	A	B	KG.x1/WT.x1	VOL.x1/UNIT VOL.
110903-033	■ NERO/BLACK	x1	10	400	320	2,20	mc. 0,004
110904-033	■ GRIGIO/GREY RAL7003	x1	10	400	320	2,20	mc. 0,004

## 07 FEEL-SCOCCA INTERA MODELLO FEEL

FEEL-PLASTIC SHELL MODEL FEEL		Q.KIT	Q.MIN/PACK	A	B	C	KG.x1/WT.x1	VOL.x1/UNIT VOL.
133915-060	■ BLU/BLUE RAL5014	x1	10	420	450	430	1,70	mc. 0,02
133907-060	■ ARANCIO/ORANGE RAL2003	x1	10	420	450	430	1,70	mc. 0,02
133903-060	■ NERO/BLACK RAL9005	x1	10	420	450	430	1,70	mc. 0,02
133916-060	■ VERDE/GREEN PANTONE 7495EL	x1	10	420	450	430	1,70	mc. 0,02
133905-060	□ BIANCO/WHITE 218	x1	10	420	450	430	1,70	mc. 0,02
133904-060	■ GRIGIO/GREY RAL7003	x1	10	420	450	430	1,70	mc. 0,02
133907-059	■ SABBIA/SAND RAL1019	x1	10	420	450	430	1,70	mc. 0,02
133902-060	■ ROSSO/RED RAL527	x1	10	420	450	430	1,70	mc. 0,02
133905-059	□ BIANCO/WHITE 218 autoestinguente/fire retardant	x1	10	420	450	430	1,70	mc. 0,02

## 08 FEEL-CONFEZIONE ACCESSORI PER SCOCCA FEEL PER TONDINO

FEEL-ACCESSORY PACK FOR WIRE FRAME FEEL		Q.KIT	Q.MIN/PACK	KG.x1/WT.x1	VOL.x1/UNIT VOL.
137015-061	■ BLU/BLUE RAL5014	x1	10	telaio in tondino/wire frame	0,07 mc. 0,001
137007-061	■ ARANCIO/ORANGE RAL2003	x1	10	telaio in tondino/wire frame	0,07 mc. 0,001
137003-061	■ NERO/BLACK RAL9005	x1	10	telaio in tondino/wire frame	0,07 mc. 0,001
137016-061	■ VERDE/GREEN PANTONE 7495EL	x1	10	telaio in tondino/wire frame	0,07 mc. 0,001
137005-061	□ BIANCO/WHITE 218	x1	10	telaio in tondino/wire frame	0,07 mc. 0,001
137004-061	■ GRIGIO/GREY RAL7003	x1	10	telaio in tondino/wire frame	0,07 mc. 0,001
137007-058	■ SABBIA/SAND RAL1019	x1	10	telaio in tondino/wire frame	0,07 mc. 0,001
137002-061	■ ROSSO/RED RAL527	x1	10	telaio in tondino/wire frame	0,07 mc. 0,001
137005-063	□ BIANCO/WHITE 218 autoestinguente/fire retardant	x1	10	telaio in tondino/wire frame	0,07 mc. 0,001

## 09 FEEL-PANNELLO SEDILE DA TAPPEZZARE

FEEL-PANEL BACK FOR UPHOLSTERY		Q.KIT	Q.MIN/PACK	A	B	KG.x1/WT.x1	VOL.x1/UNIT VOL.
132203-059	■ NERO/BLACK	x1	25	400	440	0,6	mc. 0,003

## 10 VITE HILO TB+ 5x14 ZINCATA NERA (per fissare pannello sedile)

SCREW HILO TB+ 5X14 FOR UPHOLSTERY SEAT PANEL		Q.KIT
117803-155	■ NERO/BLACK	x8

## 30 CPG-COPERTINA IN PLASTICA PER TELAIO GIREVOLE

CPG-PLASTIC COVER FOR SWIVEL FRAME		Q.KIT	Q.MIN/PACK	A	B	C	D	Ø	KG.x1/WT.x1	VOL.x1/UNIT VOL.
130903-000	■ NERO/BLACK	x1	50	60	200	210	167	36	0,1	mc. 0,0015

### OPTIONAL 30 CPG-COPERTINA IN PLASTICA PER TELAIO GIREVOLE CPG-PLASTIC COVER FOR SWIVEL FRAME





26 FEEL-SUPPORTO PER ATTACCO SCOCCA FEEL SU PANCA FEEL-BENCH FRAME FOR FEEL SHELL							
CODICE/CODE	FINITURA/FINISHING	Q. KIT	Q. MIN/PACK	A	B	KG. x1/WT.x1	VOL. x1/UNIT VOL.
110703-029	■ NERO/BLACK	x1	10	400	320	2,10	mc. 0,004

07 FEEL-SCOCCA INTERA MODELLO FEEL FEEL-PLASTIC SHELL MODEL FEEL								
CODICE/CODE	FINITURA/FINISHING	Q. KIT	Q. MIN/PACK	A	B	C	KG. x1/WT.x1	VOL. x1/UNIT VOL.
133915-060	■ BLU/BLUE RAL5014	x1	10	420	450	430	1,70	mc. 0,02
133907-060	■ ARANCIO/ORANGE RAL2003	x1	10	420	450	430	1,70	mc. 0,02
133903-060	■ NERO/BLACK RAL9005	x1	10	420	450	430	1,70	mc. 0,02
133916-060	■ VERDE/GREEN PANTONE 7495EL	x1	10	420	450	430	1,70	mc. 0,02
133905-060	□ BIANCO/WHITE 218	x1	10	420	450	430	1,70	mc. 0,02
133904-060	■ GRIGIO/GREY RAL7003	x1	10	420	450	430	1,70	mc. 0,02
133907-059	■ SABBIA/SAND RAL1019	x1	10	420	450	430	1,70	mc. 0,02
133902-060	■ ROSSO/RED RAL527	x1	10	420	450	430	1,70	mc. 0,02
133905-059	□ BIANCO/WHITE 218 autoestinguente/fire retardant	x1	10	420	450	430	1,70	mc. 0,02

08 FEEL-CONFEZIONE ACCESSORI PER SCOCCA FEEL PER TONDINO FEEL-ACCESSORY PACK FOR WIRE FRAME FEEL							
CODICE/CODE	FINITURA/FINISHING	Q. KIT	Q. MIN/PACK			KG. x1/WT.x1	VOL. x1/UNIT VOL.
137015-061	■ BLU/BLUE RAL5014	x1	10	telaio in tondino/wire frame		0,07	mc. 0,001
137007-061	■ ARANCIO/ORANGE RAL2003	x1	10	telaio in tondino/wire frame		0,07	mc. 0,001
137003-061	■ NERO/BLACK RAL9005	x1	10	telaio in tondino/wire frame		0,07	mc. 0,001
137016-061	■ VERDE/GREEN PANTONE 7495EL	x1	10	telaio in tondino/wire frame		0,07	mc. 0,001
137005-061	□ BIANCO/WHITE 218	x1	10	telaio in tondino/wire frame		0,07	mc. 0,001
137004-061	■ GRIGIO/GREY RAL7003	x1	10	telaio in tondino/wire frame		0,07	mc. 0,001
137007-058	■ SABBIA/SAND RAL1019	x1	10	telaio in tondino/wire frame		0,07	mc. 0,001
137002-061	■ ROSSO/RED RAL527	x1	10	telaio in tondino/wire frame		0,07	mc. 0,001
137005-063	□ BIANCO/WHITE 218 autoestinguente/fire retardant	x1	10	telaio in tondino/wire frame		0,07	mc. 0,001

09 FEEL-PANNELLO SEDILE DA TAPPEZZARE FEEL-PANEL BACK FOR UPHOLSTERY							
CODICE/CODE	FINITURA/FINISHING	Q. KIT	Q. MIN/PACK	A	B	KG. x1/WT.x1	VOL. x1/UNIT VOL.
132203-059	■ NERO/BLACK	x1	25	400	440	0,6	mc. 0,003

10 VITE HILO TB+ 5x14 ZINCATA NERA (per fissare pannello sedile) SCREW HILO TB+ 5X14 FOR UPHOLSTERY SEAT PANEL							
CODICE/CODE	FINITURA/FINISHING	Q. KIT					
117803-155	■ NERO/BLACK	x8					

**OPTIONAL PANCA**  
BENCH OPTIONAL



**OPTIONAL CONNETTORE PANCA**  
OPTIONAL BENCH CONNECTOR

