





manila



manila



slide

4 legs

swivel

bench

manila showing



tools



brochure



Une monocoque en plastique avec des accoudoirs intégrés.

Une large assise, confortable et robuste, au design fin et caractéristique, avec des accoudoirs dessinés pour l'envelopper. Elle est adaptable à tout type d'environnement grâce au riche assortiment de châssis offerts en option et aux nombreuses finitions.

Plus:

- des dimensions généreuses et une coque très confortable;
- un design caractéristique grâce aux accoudoirs intégrés et une coque unique;
- 6 couleurs de tendance sont disponibles pour la coque;
- une polyvalence maximale;
- le petit panneau en bois à tapisser peut être demandé en option.

Manila a été réalisée pour l'aménagement de tout type d'environnement accueillant le public et est parfaitement adaptée pour un **bureau**.

La monocarcasa de plástico con brazos integrados.

Un asiento amplio, cómodo y resistente, con un diseño esbelto y distintivo y brazos diseñados para abrazarla. Resulta sumamente versátil con su rico surtido de estructuras, opcionales también en varios acabados.

Pluses:

- dimensiones grandes y máximo confort de la carcasa;
- diseño distintivo con los brazos integrados y la carcasa única;
- 6 colores de moda para la carcasa;
- máxima versatilidad;
- galleta de madera tapizable como opcional.

Manila se ha creado para amueblar todos los **ambientes de la comunidad** y se adapta perfectamente a los **ambientes de oficina**.

manila

slide



plastic colours

- rouge/rojo p1797u
- gris/gris warm grey 6c
- ivoire/marfil ral1013
- brun/marrón ral69g
- jaune/amarillo ral110u
- bleu/azul ral5014

main component sizes

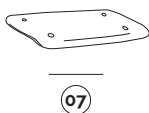
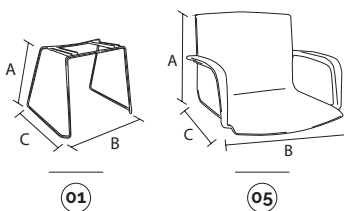

optionals

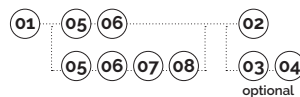
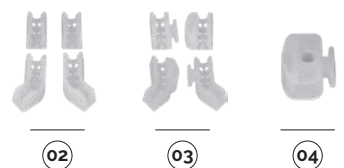

01 manila-châssis coulissant tige d.12

manila-estructura patin de varilla d. 12

code	finishing	q.kit	q.pack	a	b	c	kg.x1	vol.x1
113403-333	● noir/negro	x1	100	445	580	495	4,00	mc. 0,026
113405-333	○ ivoire/marfil ral1013	x1	100	445	580	495	4,00	mc. 0,026
113410-333	● chromé/cromado	x1	100	445	580	495	4,00	mc. 0,026

02 btf-kit pieds

btf-kit pies

code	finishing	q.kit	q.pack	kg.x1
134306-001	○ neutre/neutro	x1	100	0,05

03 btfa-kit pieds avec crochets

btfa-kit pies con ganchos

code	finishing	q.kit	q.pack	kg.x1
134306-002	○ neutre/neutro	x1	100	0,06

04 pptf-embout pour fixation au sol

pptf-tapón para fijación en el pavimento

code	finishing	q.kit	q.pack	kg.x1
134306-003	○ neutre/neutro	x2	100	0,03

05 manila-coque entière avec accoudoirs

manila-estructura completa con brazos

code	finishing	q.kit	q.pack	a	b	c	kg.x1	vol.x1
133904-045	● gris/gris warm grey 6c	x1	5	390	580	480	2,60	mc. 0,05

06 manila-vis tc+combi 6x16 tête cylindrique zinguée en croix (vis pour fixation coque)

manila-tornillo tc+combi 6x16 cabeza cilíndrica en cruz galvanizado (tornillo para fijación carcasa)

code	finishing	q.kit
117811-181	● zinguée/galvanizado	x4

07 manila-panneau assise multicouches avec 6 boulons m6

manila-galleta asiento de contrachapado con 6 remaches m6

code	finishing	q.kit	q.pack	kg.x1	vol.x1
122207-034	● hêtre/haya	x1	20	0,78	mc. 0,003

08 manila-vis tbl combi m6x12 zinguée blanche (vis pour fixation panneau)

manila-tornillo tbl combi m6x12 galvanizado blanco (tornillo para fijación galleta)

code	finishing	q.kit
117711-206	○ zinguée blanc/galvanizado blanco	x6



manila

slide



plastic colours

- rouge/rojo p1797u
- gris/gris warm grey 6c
- ivoire/marfil ral1013
- brun/marrón ral69g
- jaune/amarillo ral110u
- bleu/azul ral5014

main component sizes

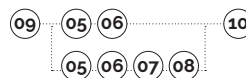
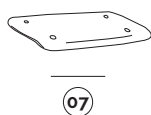
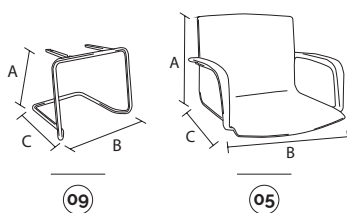

09 manila-base coulissante tube asform d.22 embouts exclus manila-base patin tubular asform d. 22 tapones excluidos

code	finishing	q.kit	q.pack	a	b	c	kg.x1	vol.x1
110503-417	● noir/negro	x1	64	450	545	545	4,10	mc. 0.0313
110504-417	● gris/gris ig2621	x1	64	450	545	545	4,10	mc. 0.0313
110505-417	○ ivoire/marfil ral1013	x1	64	450	545	545	4,10	mc. 0.0313
110510-417	● chromé/cromado	x1	64	450	545	545	4,10	mc. 0.0313

10 p2p-pince deux broches en polyéthylène noire p2p-pinza dos ganchos de polietileno negra

code	finishing	q.kit
134003-003	● noir/negro	x6

05 manila-coque entière avec accoudoirs manila-estructura completa con brazos

code	finishing	q.kit	q.pack	a	b	c	kg.x1	vol.x1
133904-045	● gris/gris warm grey 6c	x1	5	390	580	480	2,60	mc. 0.05

06 manila-vis tc-combi 6x16 tête cylindrique zinguée en croix (vis pour fixation coque) manila-tornillo tc-combi 6x16 cabeza cilíndrica en cruz galvanizado (tornillo para fijación carcasa)

code	finishing	q.kit
117811-181	● zinguée/galvanizado	x4

07 manila-panneau assise multicouches avec 6 boulons m6 manila-galleta asiento de contrachapado con 6 remaches m6

code	finishing	q.kit	q.pack	kg.x1	vol.x1
122207-034	● hêtre/haya	x1	20	0,78	mc. 0.003

08 manila-vis tbl combi m6x12 zinguée blanche (vis pour fixation panneau) manila-tornillo tbl combi m6x12 galvanizado blanco (tornillo para fijación galleta)

code	finishing	q.kit
117711-206	○ zinguée blanc/galvanizado blanco	x6



for all colour codes, see page 181

manila

4-legs

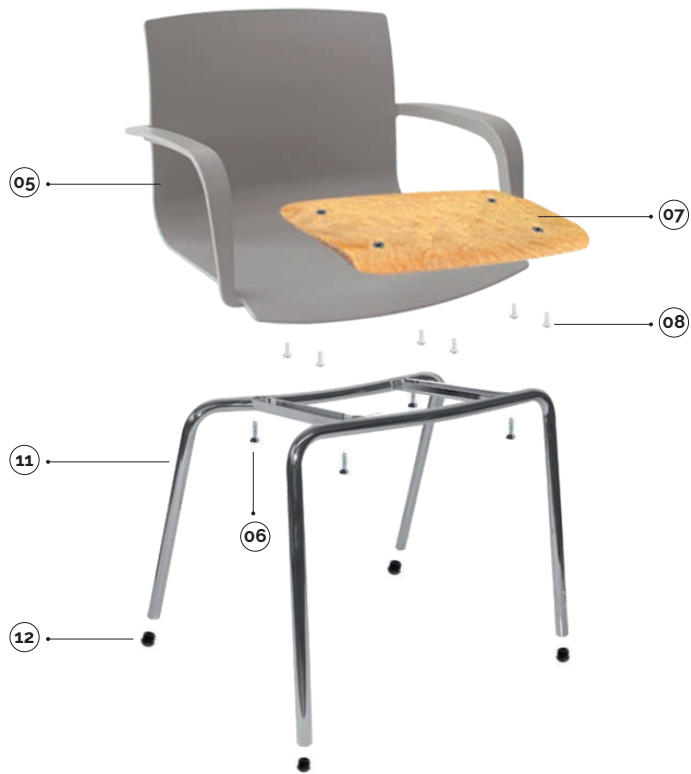

plastic colours

- rouge/rojo p1797u
- gris/gris warm grey 6c
- ivoire/marfil ral1013
- brun/marrón ral69g
- jaune/amarillo ral110u
- bleu/azul ral5014

main component sizes

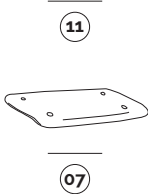
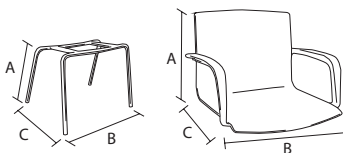

11 manila-châssis 4 pieds d.22 sans embouts

manila-estructura 4 patas d. 22 sin tapones

code	finishing	q.kit	q.pack	a	b	c	kg.x1	vol.x1
110103-259	● noir/negro	x1	80	440	585	490	2,70	mc. 0.035
110104-259	● gris/gris ig2621	x1	80	440	585	490	2,70	mc. 0.035
110105-259	○ ivoire/marfil ral1013	x1	80	440	585	490	2,70	mc. 0.035
110110-259	● chromé/cromado	x1	80	440	585	490	2,70	mc. 0.035

12 embout d.22 tête sphérique noire

tapón d.22 cabeza esférica negro

code	finishing	q.kit
134203-224	● noir/negro	x4

05 manila-coque entière avec accoudoirs

manila-estructura completa con brazos

code	finishing	q.kit	q.pack	a	b	c	kg.x1	vol.x1
133904-045	● gris/gris warm grey 6c	x1	5	390	580	480	2,60	mc. 0.05

06 manila-vis tc+combi 6x16 tête cylindrique zinguée en croix (vis pour fixation coque)

manila-tornillo tc+combi 6x16 cabeza cilíndrica en cruz galvanizado (tornillo para fijación carcasa)

code	finishing	q.kit
117811-181	● zinguée/galvanizado	x4

07 manila-panneau assise multicouches avec 6 boulons m6

manila-galleta asiento de contrachapado con 6 remaches m6

code	finishing	q.kit	q.pack	kg.x1	vol.x1
122207-034	● hêtre/haya	x1	20	0,78	mc. 0.003

08 manila-vis tbl combi m6x12 zinguée blanche (vis pour fixation panneau)

manila-tornillo tbl combi m6x12 galvanizado blanco (tornillo para fijación galleta)

code	finishing	q.kit
117711-206	○ zinguée blanc/galvanizado blanco	x6



for all colour codes, see page 181

manila

swivel



plastic colours

- rouge/rojo p1797u
- gris/gris warm grey 6c
- ivoire/marfil ral1013
- brun/marrón ral69g
- jaune/amarillo ral110u
- bleu/azul ral5014

main component sizes

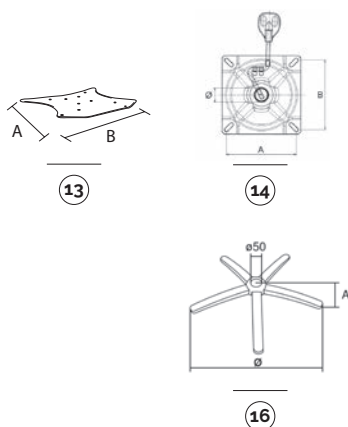

optional

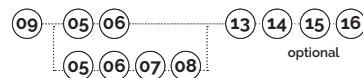
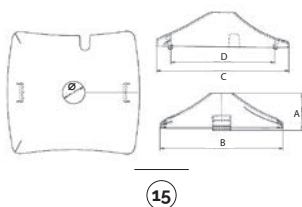

13 manila-châssis pour pivotant/banquette
manila-estructura para versión giratoria/bancada

code	finishing	q.kit	q.pack	a	b	kg.x1	vol.x1
110903-256	● noir/negro	x1	10	265	325	2,00	mc. 0.0019
110904-256	● gris/gris ig2621	x1	10	265	325	2,00	mc. 0.0019

14 pss28nr-plaque tabouret av/levier c/28 3" l4 noire
pss28nr- placa taburete con palanca c/28 3" l4 negra

code	finishing	q.kit	q.pack	a	b	ø	kg.x1	vol.x1
113003-104	● noir/negro	x1	25	150	150	28	1,23	mc. 0.002

15 cpg-couverture en plastique pour châssis pivotant
cpg-cubierta de plástico para estructura versión giratoria

code	finishing	q.kit	q.pack	a	b	c	d	ø	kg.x1	vol.x1
130903-000	● noir/negro	x1	50	60	200	210	167	36	0,1	mc. 0.0015

16 b40-base en métal avec cache-soudure
b40-base de metal con embellecedor soldadura

code	finishing	q.kit	q.pack	a	ø	kg.x1	vol.x1
110210-027	● chromé/cromado	x1	5	60	640	2,85	mc. 0.014

for the components below, see page 178

05 06 07 08

CPG
plastic cover for swivel frame



for all colour codes, see page 181

manila

bench



plastic colours

- rouge/rojo p1797u
- gris/gris warm grey 6c
- ivoire/marfil ral1013
- brun/marrón ral69g
- jaune/amarillo ral110u
- bleu/azul ral5014

main component sizes

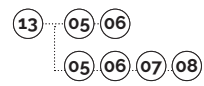
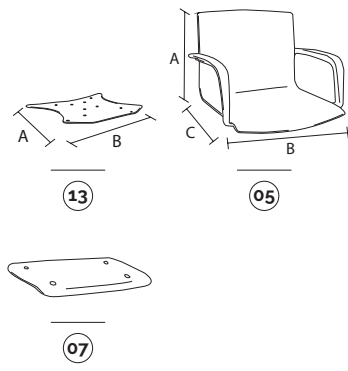

13 manila-châssis pour pivotant/banquette
manila-estructura para versión giratoria/bancada

code	finishing	q.kit	q.pack	a	b	kg.x1	vol.x1
110903-256	● noir/negro	x1	10	265	325	2,00	mc. 0,0019
110904-256	● gris/gris ig2621	x1	10	265	325	2,00	mc. 0,0019

05 manila-coque entière avec accoudoirs
manila-estructura completa con brazos

code	finishing	q.kit	q.pack	a	b	c	kg.x1	vol.x1
133904-045	● gris/gris warm grey 6c	x1	5	390	580	480	2,60	mc. 0,05

06 manila-vis tc+combi 6x16 tête cylindrique zinguée en croix (vis pour fixation coque)
manila-tornillo tc+combi 6x16 cabeza cilíndrica en cruz galvanizado (tornillo para fijación carcasa)

code	finishing	q.kit
117811-181	● zinguée/galvanizado	x4

07 manila-panneau assise multicouches avec 6 boulons m6
manila-galleta asiento de contrachapado con 6 remaches m6

code	finishing	q.kit	q.pack	kg.x1	vol.x1
122207-034	● hêtre/haya	x1	20	0,78	mc. 0,003

08 manila-vis tbl combi m6x12 zinguée blanche (vis pour fixation panneau)
manila-tornillo tbl combi m6x12 galvanizado blanco (tornillo para fijación galleta)

code	finishing	q.kit
117711-206	○ zinguée blanc/galvanizado blanco	x6

for the bench components, see page 249

for all colour codes, see page 181

optionals

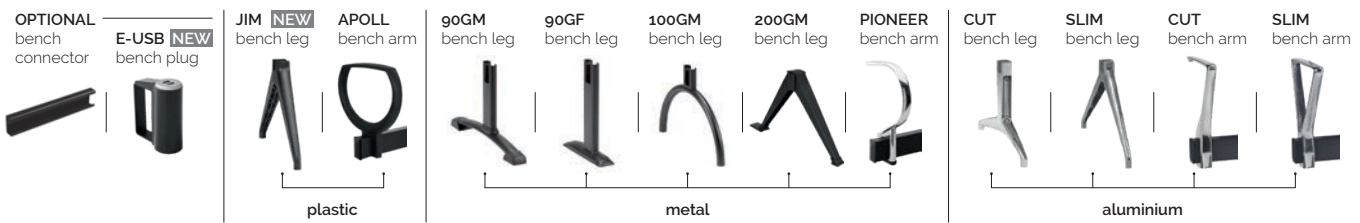

manila

optional colour codes



shell colour codes



05 coque entière en plastique
estructura completa en plástico

- 133902-045 rouge/rojo p1797u
- 133904-045 gris/gris warm grey 6c
- 133905-045 ivoire/marfil ral1013
- 133907-045 brun/marrón ral699
- 133908-045 jaune/amarillo ral110u
- 133915-045 bleu/azul ral5014

