

nexus

bench

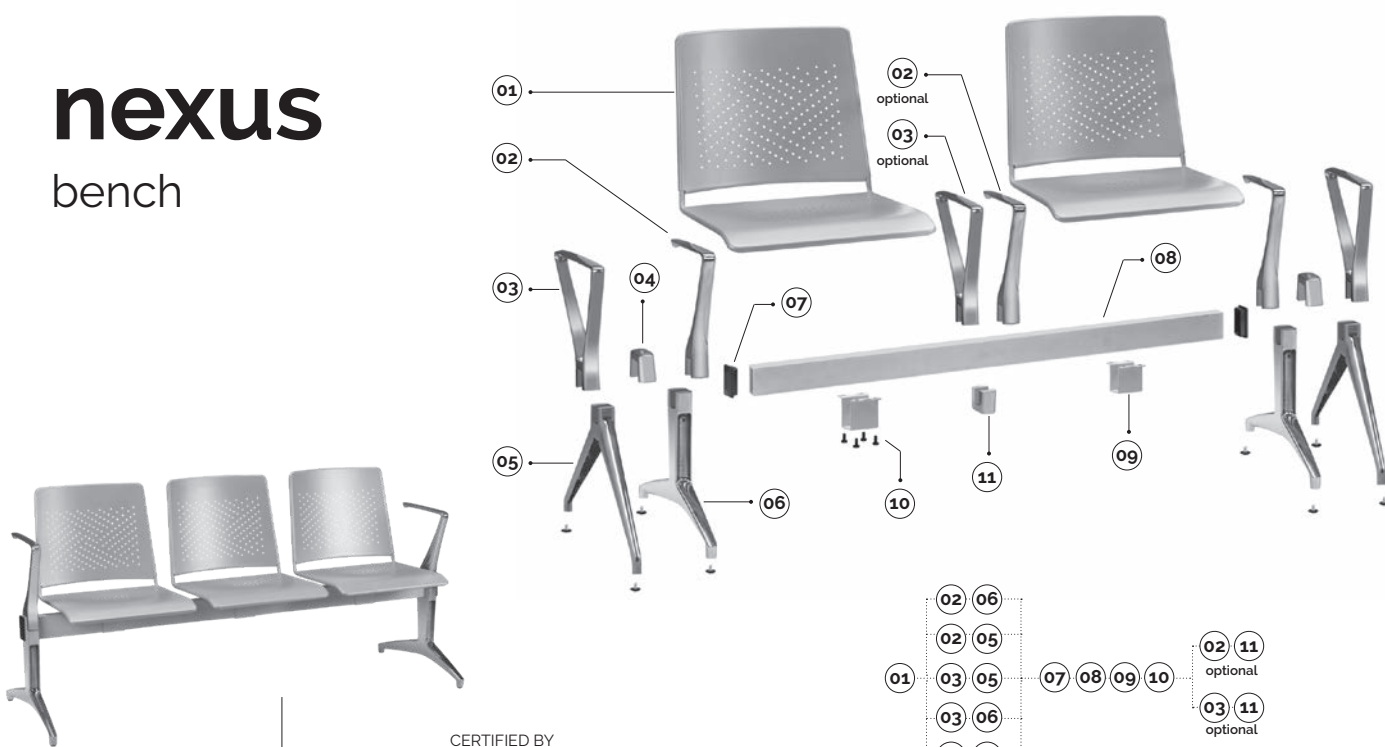

CERTIFIED BY
CATAS

Corten • *Une caractéristique spécifique du Corten est la variabilité dans la tonalité de la finition.
* Una característica particular del Corten es las variabilidad en la tonalidad del acabado.

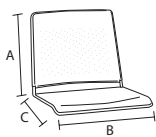

01



04

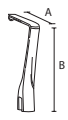

02

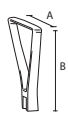

03

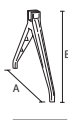

05

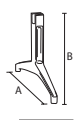

06

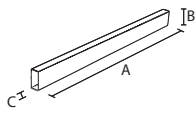

08

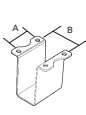

09

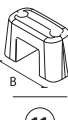

11

main component sizes

01 nexus-coque en tôle
nexus-carcasa de chapa

code	finishing	q.kit	q.pack	a	b	c	kg.x1	vol.x1
110703-220	● noir/negro	x1	60	405	454	545	7,60	mc. 0.02
110704-220	● gris/gris	x1	60	405	454	545	7,60	mc. 0.02
110705-220	○ blanc/blanco ral9010	x1	60	405	454	545	7,60	mc. 0.02
110707-220	● corten*	x1	60	405	454	545	7,60	mc. 0.02

02 cut-accoudoir en aluminium pour banquette + 2 vis
cut-brazo de aluminio para bancada + n.2 tornillos

code	finishing	q.kit	q.pack	a	b	kg.x1	vol.x1
111704-223	● aluminium/aluminio	x1	10	300	305	1,40	mc. 0.0011

03 slim-accoudoir en aluminium pour banquette + 2 vis
slim-brazo de aluminio para bancada + n.2 tornillos

code	finishing	q.kit	q.pack	a	b	kg.x1	vol.x1
111704-225	● aluminium/aluminio	x1	10	325	305	1,40	mc. 0.0011

04 cut/slim-cavalier en aluminium pour pied banquette + 2 vis
cut/slim caballete de aluminio para pata bancada + n.2 tornillos

code	finishing	q.kit	q.pack	a	b	kg.x1	vol.x1
111704-222	● aluminium/aluminio	x1	10	60	95	0,40	mc. 0.0012

05 slim-pied en aluminium pour banquette + 2 pieds
slim-pata de aluminio para bancada + n.2 pies

code	finishing	q.kit	q.pack	a	b	kg.x1	vol.x1
111704-226	● aluminium/aluminio	x2	5	610	350	1,20	mc. 0.014

06 cut-pied en aluminium pour banquette + 2 pieds
cut-pata de aluminio para bancada + n.2 pies

code	finishing	q.kit	q.pack	a	b	kg.x1	vol.x1
111704-224	● aluminium/aluminio	x2	5	610	350	2,55	mc. 0.014

07 embout couvre-tête rectangulaire 80x40 noir
tapon embellecedor rectangular 80 x 40 negro

code	finishing	q.kit
134103-001	● noir/negro	x2

08 got(03) poutre pour banquette 80x40
got(03) viga para bancada 80x40

code	finishing		q.kit	q.pack	a	b	c	kg.x1	vol.x1
110703-190	● noir/negro	2 places/2 asientos	x1	1	1160	80	40	3,20	mc. 0.0045
110704-090	● gris/gris	2 places/2 asientos	x1	1	1160	80	40	3,20	mc. 0.0045
110703-191	● noir/negro	3 places/3 asientos	x1	1	1710	80	40	4,71	mc. 0.005
110704-091	● gris/gris	3 places/3 asientos	x1	1	1710	80	40	4,71	mc. 0.005
110703-192	● noir/negro	4 places/4 asientos	x1	1	2260	80	40	6,22	mc. 0.0085
110704-092	● gris/gris	4 places/4 asientos	x1	1	2260	80	40	6,22	mc. 0.0085
110703-193	● noir/negro	5 places/5 asientos	x1	1	2800	80	40	7,72	mc. 0.01
110704-193	● gris/gris	5 places/5 asientos	x1	1	2800	80	40	7,72	mc. 0.01

09 90cv-cavalier pour dessous poutre
90cv-caballete bajo viga

code	finishing	q.kit	q.pack	a	b	kg.x1	vol.x1
110703-007	● noir/negro	x1	50	55	65	0,60	mc. 0.0005
110704-016	● gris/gris	x1	50	55	65	0,60	mc. 0.0005

10 pack vis m8x12 tête cylindrique hexagonale encaissée brunie noire
paquete de tornillos m8x12 cabeza cilindrica hexagonal embutida bruniado negro

code	finishing	q.kit	q.pack
117003-070	● noir/negro	x4	200

11 cut/slim-cavalier en aluminium pour accoudoir banquette
cut/slim caballete de aluminio para brazo bancada

code	finishing	q.kit	q.pack	a	b	kg.x1	vol.x1
111704-221	● aluminium/aluminio	x1	10	58	95	0,32	mc. 0.0012

for the bench components, see page 249

nexus

bench leg options

• optional

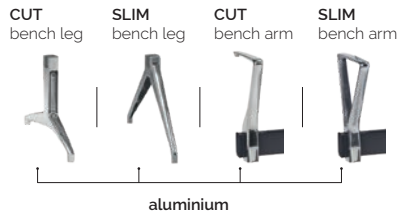
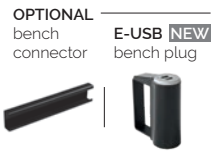

bench sizes

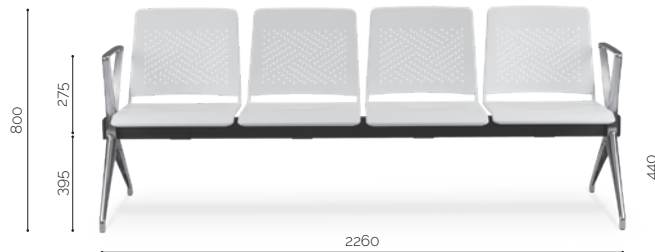
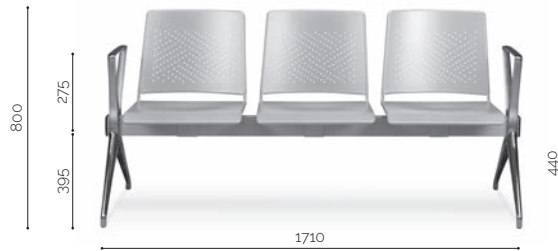
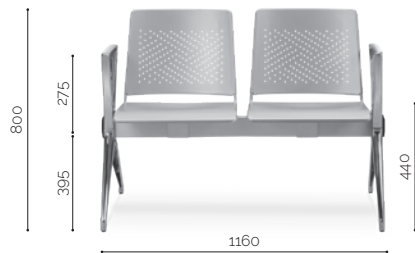

nexus

bench

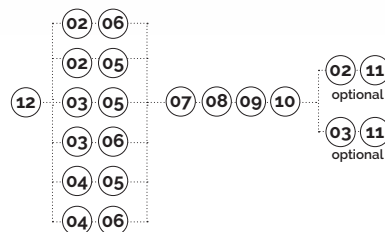
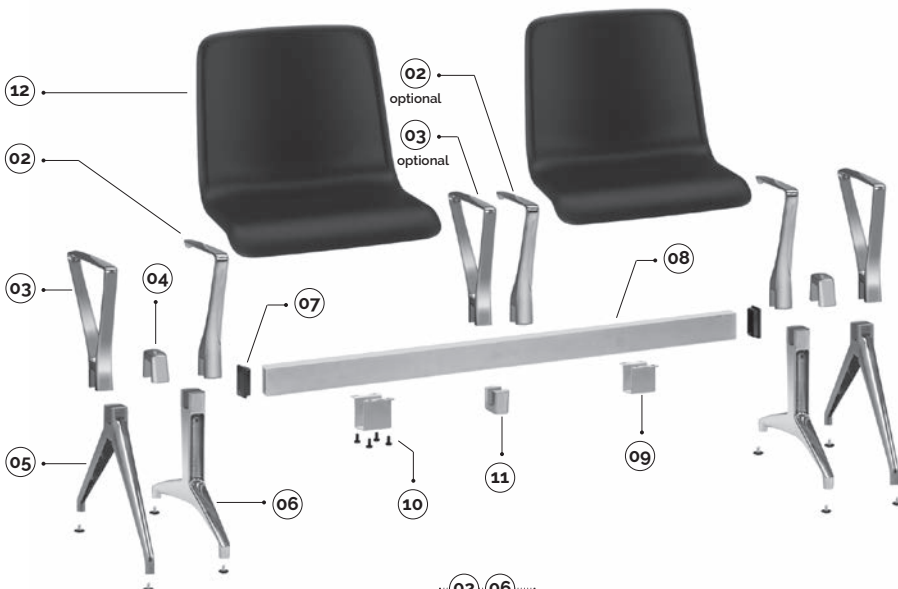

Proposée dans différentes couleurs mono/bi-couleur en lots de 100 pièces

12

Disponible en différentes couleurs mono/bi-couleur para lotes de 100 unidades

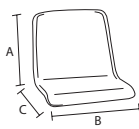

12



04

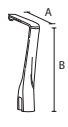

03

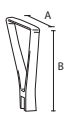

04

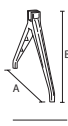

05

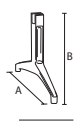

06

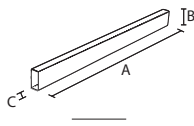

08

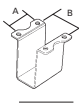

09

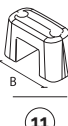

10



11

12 nexus-coque en polyurethane souple freeform advanced
nexus-carcasa de poliuretano blando freeform advanced

code	finishing	q.kit	q.pack	a	b	c	kg.x1	vol.x1
133903-061	● noir/negro	x1		410	485	430	7,60	mc. 0.09

02 cut-accouider en aluminium pour banquette + 2 vis
cut-brazo de aluminio para bancada + n.2 tornillos

code	finishing	q.kit	q.pack	a	b	kg.x1	vol.x1
111704-223	● aluminium/aluminio	x1	10	300	305	1,40	mc. 0.0011

03 slim-accouider en aluminium pour banquette + 2 vis
slim-brazo de aluminio para bancada + n.2 tornillos

code	finishing	q.kit	q.pack	a	b	kg.x1	vol.x1
111704-225	● aluminium/aluminio	x1	10	325	305	1,40	mc. 0.0011

04 cut/slim-caballate en aluminium pour pata banquette + 2 vis
cut/slim caballate de aluminio para pata bancada + n.2 tornillos

code	finishing	q.kit	q.pack	a	b	kg.x1	vol.x1
111704-222	● aluminium/aluminio	x1	10	60	95	0,40	mc. 0.0012

05 slim-pata en aluminium pour banquette + 2 pieds
slim-pata de aluminio para bancada + n.2 pies

code	finishing	q.kit	q.pack	a	b	kg.x1	vol.x1
111704-226	● aluminium/aluminio	x2	5	610	350	1,20	mc. 0.014

06 cut-pata en aluminium pour banquette + 2 pieds
cut-pata de aluminio para bancada + n.2 pies

code	finishing	q.kit	q.pack	a	b	kg.x1	vol.x1
111704-224	● aluminium/aluminio	x2	5	610	350	2,55	mc. 0.014

07 embout couvre-tête rectangulaire 80x40 noir
tapón embellecedor rectangular 80 x 40 negro

code	finishing	q.kit
134103-001	● noir/negro	x2

08 90°(03) poutre pour banquette 80x40
90°(03) viga para bancada 80x40

code	finishing	places/asientos	q.kit	q.pack	a	b	c	kg.x1	vol.x1
110703-190	● noir/negro	2 places/2 asientos	x1	1	1160	80	40	3,20	mc. 0.0045
110704-090	● gris/gris	2 places/2 asientos	x1	1	1160	80	40	3,20	mc. 0.0045
110703-191	● noir/negro	3 places/3 asientos	x1	1	1710	80	40	4,71	mc. 0.005
110704-091	● gris/gris	3 places/3 asientos	x1	1	1710	80	40	4,71	mc. 0.005
110703-192	● noir/negro	4 places/4 asientos	x1	1	2260	80	40	6,22	mc. 0.0085
110704-092	● gris/gris	4 places/4 asientos	x1	1	2260	80	40	6,22	mc. 0.0085
110703-193	● noir/negro	5 places/5 asientos	x1	1	2800	80	40	7,72	mc. 0.01
110704-193	● gris/gris	5 places/5 asientos	x1	1	2800	80	40	7,72	mc. 0.01

09 g0cv-cavalier pour dessous poutre
g0cv-caballate bajo viga

code	finishing	q.kit	q.pack	a	b	kg.x1	vol.x1
110703-007	● noir/negro	x1	50	55	65	0,60	mc. 0.0005
110704-016	● gris/gris	x1	50	55	65	0,60	mc. 0.0005

10 pack vis m8x12 tête cylindrique hexagonale encaissée brunie noire
paquete de tornillos m8x12 cabeza cilíndrica hexagonal embutida bruñida negro

code	finishing	q.kit	q.pack
117003-070	● noir/negro	x4	200

11 cut/slim-cavalier en aluminium pour accouider banquette
cut/slim caballate de aluminio para brazo bancada

code	finishing	q.kit	q.pack	a	b	kg.x1	vol.x1
111704-221	● aluminium/aluminio	x1	10	58	95	0,32	mc. 0.0012

for the bench components, see page 249

