



A new Generation
NEXT to US



Designed by:
**ESEDRA &
ALESSANDROCROSERA&PARTNERS**



Configurator available



Certified

NEXUS

Una scocca completamente in metallo, forata e dal design moderno e minimal, capace di dare il meglio di sé sia nella versione panca che nella versione sedia. Le nuove gambe e braccioli per panca in alluminio aggiungono stile ed eleganza ad un prodotto certificato CATAS, quindi perfetto per ogni situazione di tipo contract o attesa.

A full metal shell, perforated and minimalist modern design, able to give the best of itself as both a bench and a chair. The new aluminum bench legs and armrests add style and elegance to a CATAS certified product, making it perfect for every contract or waiting environment.

NEW!



EN 16139

albacomponents



NEXUS

■ . inspired by ALBA

SLIDE

4 LEGS

BENCH



CERTIFIED BY
CATAS

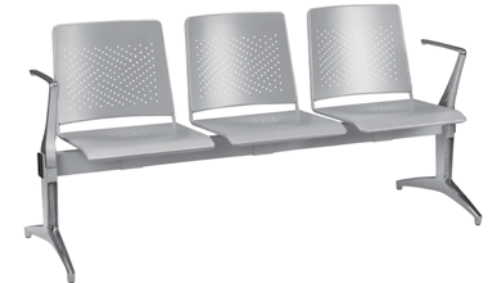

NEXUS BENCH

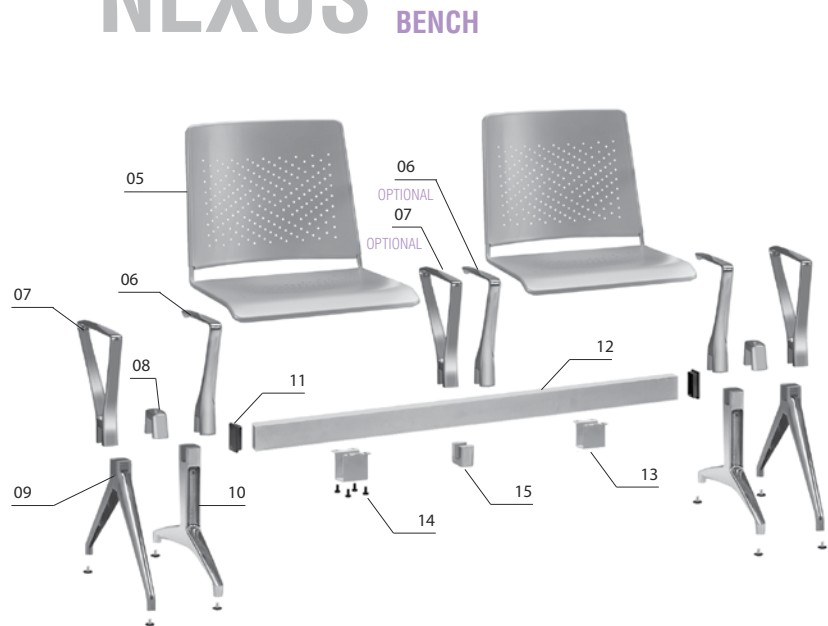

PER I COMPONENTI DELLA PANCA VAI A PAG. 337
FOR THE BENCH COMPONENTS GO TO PAGE 337

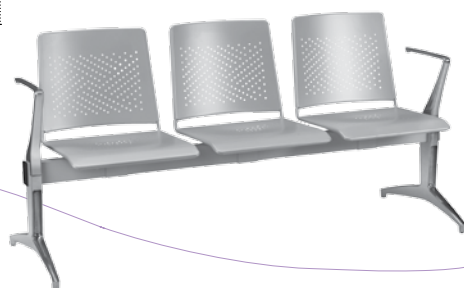
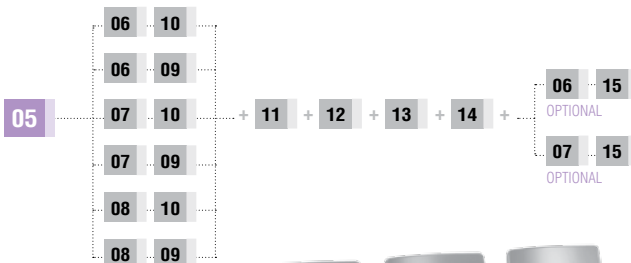
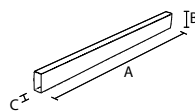
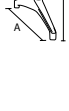
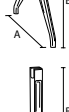
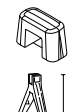
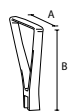
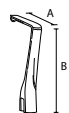
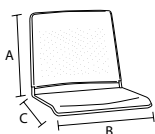

05 NEXUS-SCocca IN LAMIERA NEXUS-SHELL METAL SHEET									
CODICE/CODE	FINITURA/FINISHING	Q. KIT	Q. MIN./PACK	A	B	C	KG. x1/WT.x1	VOL. x1/UNIT VOL.	
110703-220	■ NERO/BLACK	x1	60	405	454	545	7,60	mc. 0,02	
110704-220	■ GRIGIO/GREY	x1	60	405	454	545	7,60	mc. 0,02	
110705-220	□ BIANCO/WHITE	x1	60	405	454	545	7,60	mc. 0,02	RAL9010
110707-220	■ CORTEN	x1	60	405	454	545	7,60	mc. 0,02	

06 NEXUS-CUT-BRACCIOLO IN ALLUMINIO PER PANCA + N°2 VITI NEXUS-CUT-ALUMINIUM ARM FOR BENCH + N°2 SCREW									
CODICE/CODE	FINITURA/FINISHING	Q. KIT	Q. MIN./PACK	A	B	KG. x1/WT.x1	VOL. x1/UNIT VOL.		
111704-223	■ ALLUMINIO/ALUMINIUM	x1	10	300	305	1,40	mc. 0,0011		

07 NEXUS-SLIM-BRACCIOLO IN ALLUMINIO PER PANCA + N°2 VITI NEXUS-SLIM-ALUMINIUM ARM FOR BENCH + N°2 SCREW									
CODICE/CODE	FINITURA/FINISHING	Q. KIT	Q. MIN./PACK	A	B	KG. x1/WT.x1	VOL. x1/UNIT VOL.		
111704-225	■ ALLUMINIO/ALUMINIUM	x1	10	325	305	1,40	mc. 0,0011		

08 NEXUS-CUT/SLIM-CAVALLOTTO IN ALLUMINIO PER GAMBA PANCA + N°2 VITI NEXUS-CUT/SLIM-ALUMINIUM BRACKET 80X40 FOR BENCH LEG + N°2 SCREW									
CODICE/CODE	FINITURA/FINISHING	Q. KIT	Q. MIN./PACK	KG. x1/WT.x1	VOL. x1/UNIT VOL.				
111704-222	■ ALLUMINIO/ALUMINIUM	x1	10	0,40	mc. 0,0012				

09 NEXUS-SLIM-GAMBA IN ALLUMINIO PER PANCA NEXUS-SLIM-ALUMINIUM LEG FOR BENCH									
CODICE/CODE	FINITURA/FINISHING	Q. KIT	Q. MIN./PACK	A	B	KG. x1/WT.x1	VOL. x1/UNIT VOL.		
111704-226	■ ALLUMINIO/ALUMINIUM	x2	5	610	350	1,20	mc. 0,014		

10 NEXUS-CUT-GAMBA IN ALLUMINIO PER PANCA NEXUS-CUT-ALUMINIUM LEG FOR BENCH									
CODICE/CODE	FINITURA/FINISHING	Q. KIT	Q. MIN./PACK	A	B	KG. x1/WT.x1	VOL. x1/UNIT VOL.		
111704-224	■ ALLUMINIO/ALUMINIUM	x2	5	610	350	2,55	mc. 0,014		

11 TAPPO COPRITESTA RETTANGOLARE 80x40 NERO RECTANGULAR COVER HEAD CAP 80X40 BLACK									
CODICE/CODE	FINITURA/FINISHING	Q. KIT	Q. MIN./PACK	KG. x1/WT.x1	VOL. x1/UNIT VOL.				
134103-001	■ NERO/BLACK	x2							

12 90T(03) TRAVE PER PANCA 80X40 90T(03) BEAM FOR BENCH 80X40									
CODICE/CODE	FINITURA/FINISHING	Q. KIT	Q. MIN./PACK	A	B	C	KG. x1/WT.x1	VOL. x1/UNIT VOL.	
110703-190	■ NERO/BLACK	2 POSTI / 2 SEATS	x1	1	1160	80	40	3,20	mc. 0,0045
110704-090	■ GRIGIO/GREY	2 POSTI / 2 SEATS	x1	1	1160	80	40	3,20	mc. 0,0045
110703-191	■ NERO/BLACK	3 POSTI / 3 SEATS	x1	1	1710	80	40	4,71	mc. 0,005
110704-091	■ GRIGIO/GREY	3 POSTI / 3 SEATS	x1	1	1710	80	40	4,71	mc. 0,005
110703-192	■ NERO/BLACK	4 POSTI / 4 SEATS	x1	1	2260	80	40	6,22	mc. 0,0085
110704-092	■ GRIGIO/GREY	4 POSTI / 4 SEATS	x1	1	2260	80	40	6,22	mc. 0,0085
110703-193	■ NERO/BLACK	5 POSTI / 5 SEATS	x1	1	2800	80	40	7,72	mc. 0,01
110704-193	■ GRIGIO/GREY	5 POSTI / 5 SEATS	x1	1	2800	80	40	7,72	mc. 0,01

13 90CV-CAVALLOTTO SOTTO TRAVE 90CV-SUPPORT UNDER BEAM									
CODICE/CODE	FINITURA/FINISHING	Q. KIT	Q. MIN./PACK	A	B	KG. x1/WT.x1	VOL. x1/UNIT VOL.		
110703-007	■ NERO/BLACK	x1	50	55	65	0,60	mc. 0,0005		
110704-016	■ GRIGIO/GREY	x1	50	55	65	0,60	mc. 0,0005		

14 CONFEZIONE VITI M8X12 TESTA CILINDRICA A ESAGONO INCASSATO BRUNITA NERA SCREWS M8X12 CYLINDRICAL HEAD HEXAGON EMBEDDED BURNISHING BLACK PACKAGE									
CODICE/CODE	FINITURA/FINISHING	Q. KIT	Q. MIN./PACK	KG. x1/WT.x1	VOL. x1/UNIT VOL.				
117003-070	■ NERO/BLACK	x4	200						

15 NEXUS-CUT/SLIM-CAVALLOTTO IN ALLUMINIO PER BRACCIOLO PANCA NEXUS-CUT/SLIM-ALUMINIUM BRACKET 80X40 FOR BENCH ARM									
CODICE/CODE	FINITURA/FINISHING	Q. KIT	Q. MIN./PACK	KG. x1/WT.x1	VOL. x1/UNIT VOL.				
111704-221	■ ALLUMINIO/ALUMINIUM	x1	10	0,32	mc. 0,0012				

OPTIONAL PANCA
BENCH OPTIONAL



OPTIONAL CONNETTORE PANCA
OPTIONAL BENCH CONNECTOR



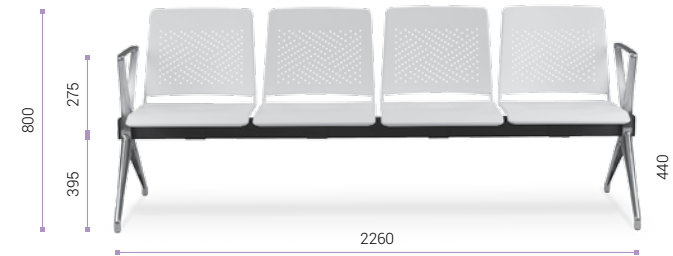
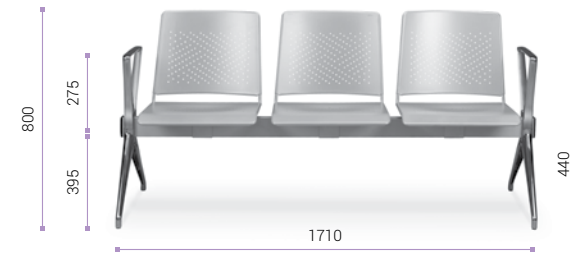
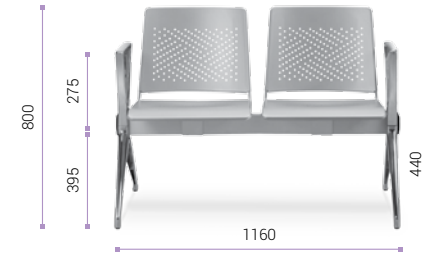
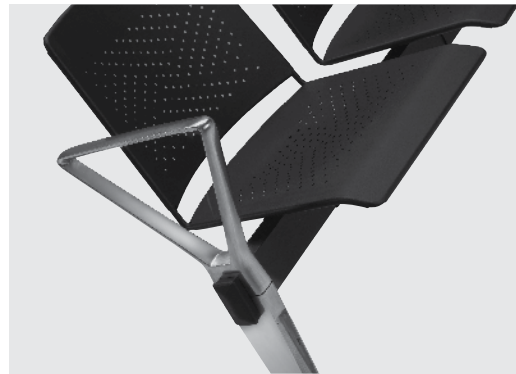
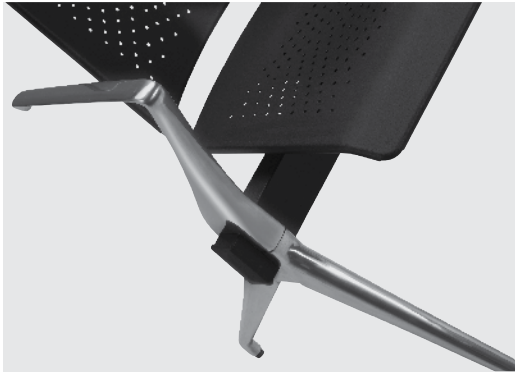

NEXUS BENCH

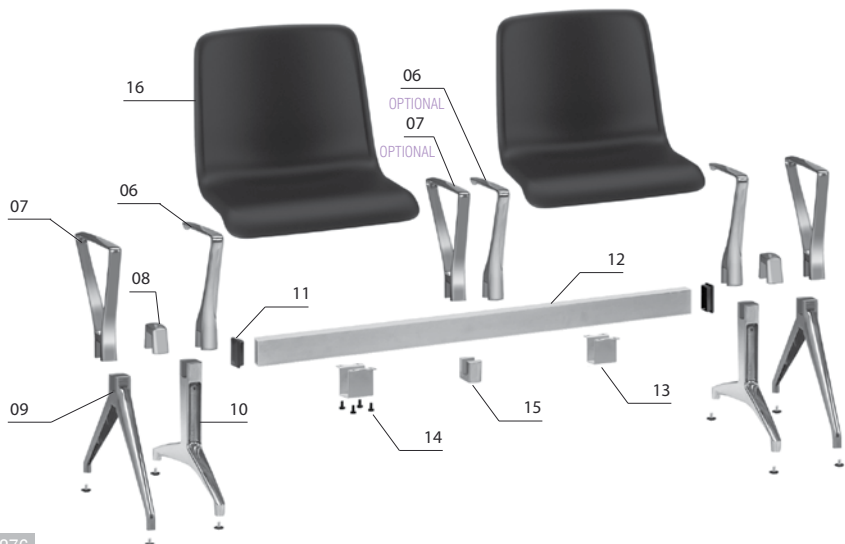

PER I COMPONENTI DELLA PANCA VAI A PAG. 337
FOR THE BENCH COMPONENTS GO TO PAGE 337

16 Disponibile in diversi colori mono/bi-colour per lotti da 100 pezzi
Available in different colours mono/bi-colour for batches from 100 pcs

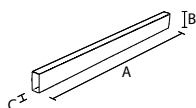
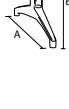
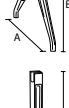
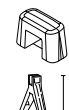
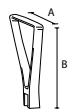
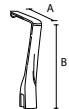
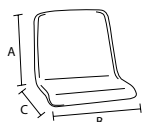
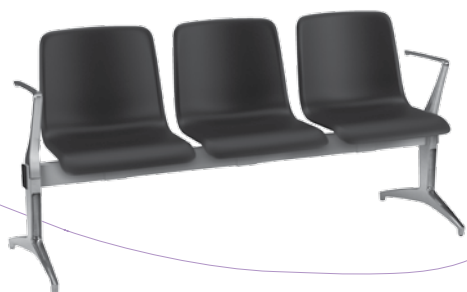
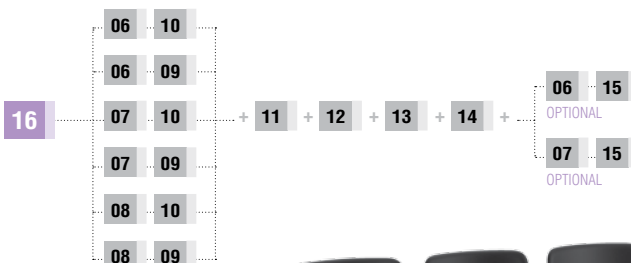

OPTIONAL PANCA
BENCH OPTIONAL



OPTIONAL CONNETTORE PANCA
OPTIONAL BENCH CONNECTOR



16	NEXUS-SCocca IN POLIURETANO MORBIDO FREEFORM ADVANCED NEXUS-HALF-SOFT POLYURETHANE FREEFORM ADVANCED SHELL MODEL										
CODICE/CODE	FINITURA/FINISHING	Q. KIT		A	B	C		KG. x1/WT.x1		VOL. x1/UNIT VOL.	
133903-061	■ NERO/BLACK	x1		410	485	430		7,60		mc. 0,09	
06	NEXUS-CUT-BRACCIOLO IN ALLUMINIO PER PANCA + N°2 VITI NEXUS-CUT-ALUMINIUM ARM FOR BENCH + N°2 SCREW										
CODICE/CODE	FINITURA/FINISHING	Q. KIT	Q. MIN/PACK	A	B			KG. x1/WT.x1		VOL. x1/UNIT VOL.	
111704-223	■ ALLUMINIO/ALUMINIUM	x1	10	300	305			1,40		mc. 0,0011	
07	NEXUS-SLIM-BRACCIOLO IN ALLUMINIO PER PANCA + N°2 VITI NEXUS-SLIM-ALUMINIUM ARM FOR BENCH + N°2 SCREW										
CODICE/CODE	FINITURA/FINISHING	Q. KIT	Q. MIN/PACK	A	B			KG. x1/WT.x1		VOL. x1/UNIT VOL.	
111704-225	■ ALLUMINIO/ALUMINIUM	x1	10	325	305			1,40		mc. 0,0011	
08	NEXUS-CUT/SLIM-CAVALLOTTO IN ALLUMINIO PER GAMBA PANCA + N°2 VITI NEXUS-CUT/SLIM-ALUMINIUM BRACKET 80X40 FOR BENCH LEG + N°2 SCREW										
CODICE/CODE	FINITURA/FINISHING	Q. KIT	Q. MIN/PACK					KG. x1/WT.x1		VOL. x1/UNIT VOL.	
111704-222	■ ALLUMINIO/ALUMINIUM	x1	10					0,40		mc. 0,0012	
09	NEXUS-SLIM-GAMBA IN ALLUMINIO PER PANCA NEXUS-SLIM-ALUMINIUM LEG FOR BENCH										
CODICE/CODE	FINITURA/FINISHING	Q. KIT	Q. MIN/PACK	A	B			KG. x1/WT.x1		VOL. x1/UNIT VOL.	
111704-226	■ ALLUMINIO/ALUMINIUM	x2	5	610	350			1,20		mc. 0,014	
10	NEXUS-CUT-GAMBA IN ALLUMINIO PER PANCA NEXUS-CUT-ALUMINIUM LEG FOR BENCH										
CODICE/CODE	FINITURA/FINISHING	Q. KIT	Q. MIN/PACK	A	B			KG. x1/WT.x1		VOL. x1/UNIT VOL.	
111704-224	■ ALLUMINIO/ALUMINIUM	x2	5	610	350			2,55		mc. 0,014	
11	TAPPO COPRITESTA RETTANGOLARE 80x40 NERO RECTANGULAR COVER HEAD CAP 80X40 BLACK										
CODICE/CODE	FINITURA/FINISHING	Q. KIT									
134103-001	■ NERO/BLACK	x2									
12	90T(03) TRAVE PER PANCA 80X40 90T(03) BEAM FOR BENCH 80X40										
CODICE/CODE	FINITURA/FINISHING	Q. KIT	Q. MIN/PACK	A	B	C		KG. x1/WT.x1		VOL. x1/UNIT VOL.	
110703-190	■ NERO/BLACK	2 POSTI / 2 SEATS	x1	1	1160	80	40	3,20		mc. 0,0045	
110704-090	■ GRIGIO/GREY	2 POSTI / 2 SEATS	x1	1	1160	80	40	3,20		mc. 0,0045	
110703-191	■ NERO/BLACK	3 POSTI / 3 SEATS	x1	1	1710	80	40	4,71		mc. 0,005	
110704-091	■ GRIGIO/GREY	3 POSTI / 3 SEATS	x1	1	1710	80	40	4,71		mc. 0,005	
110703-192	■ NERO/BLACK	4 POSTI / 4 SEATS	x1	1	2260	80	40	6,22		mc. 0,0085	
110704-092	■ GRIGIO/GREY	4 POSTI / 4 SEATS	x1	1	2260	80	40	6,22		mc. 0,0085	
110703-193	■ NERO/BLACK	5 POSTI / 5 SEATS	x1	1	2800	80	40	7,72		mc. 0,01	
110704-193	■ GRIGIO/GREY	5 POSTI / 5 SEATS	x1	1	2800	80	40	7,72		mc. 0,01	
13	90CV-CAVALLOTTO SOTTO TRAVE 90CV-SUPPORT UNDER BEAM										
CODICE/CODE	FINITURA/FINISHING	Q. KIT	Q. MIN/PACK	A	B			KG. x1/WT.x1		VOL. x1/UNIT VOL.	
110703-007	■ NERO/BLACK	x1	50	55	65			0,60		mc. 0,0005	
110704-016	■ GRIGIO/GREY	x1	50	55	65			0,60		mc. 0,0005	
14	CONFEZIONE VITI M8X12 TESTA CILINDRICA A ESAGONO INCASSATO BRUNITA NERA SCREWS M8X12 CYLINDRICAL HEAD HEXAGON EMBEDDED BURNISHING BLACK PACKAGE										
CODICE/CODE	FINITURA/FINISHING	Q. KIT	Q. MIN/PACK								
117003-070	■ NERO/BLACK	x4	200								
15	NEXUS-CUT/SLIM-CAVALLOTTO IN ALLUMINIO PER BRACCIOLO PANCA NEXUS-CUT/SLIM-ALUMINIUM BRACKET 80X40 FOR BENCH ARM										
CODICE/CODE	FINITURA/FINISHING	Q. KIT	Q. MIN/PACK					KG. x1/WT.x1		VOL. x1/UNIT VOL.	
111704-221	■ ALLUMINIO/ALUMINIUM	x1	10					0,32		mc. 0,0012	

16



PARTE ESTERNA - EXTERNAL PART

Antracite - Anthracite	Arancio - Orange	Aavorio - Ivory	Azzurro - Azur	Bianco azzurrato - White	Blu scuro - Dark blue	Blu oltremare - Ultramarine blue	Blu petrolio - Petroleum blue	Fango - Mud	Giallo ginestra - Broom yellow	Giallo traffico - Traffic yellow	Grigio medio - Medium grey	Grigio luce - Light grey	Grigio Londra - London grey	Grigio traffico - Traffic grey	Marrone cioccolato - Chocolate brown	Moka	Nero - Black	Rosso carminio - Carmine red	Rosso porpora - Purple red	Rosso rubino - Ruby red	Rosso ossido - Oxide red	Sabbia - Sandy	Tortora - Dove	Verde smeraldo - Emerald green	Verde pallido - Pale green	Verde chiaro - Light green	Verde foresta - Forest green	Verde mela - Apple green	Verde felce - Fern green	Viola traffico - Traffic violet	Lilla - Liliac
------------------------	------------------	-----------------	----------------	--------------------------	-----------------------	----------------------------------	-------------------------------	-------------	--------------------------------	----------------------------------	----------------------------	--------------------------	-----------------------------	--------------------------------	--------------------------------------	------	--------------	------------------------------	----------------------------	-------------------------	--------------------------	----------------	----------------	--------------------------------	----------------------------	----------------------------	------------------------------	--------------------------	--------------------------	---------------------------------	----------------

PARTE INTERNA - INNER PART

Antracite - Anthracite	•				•	•	•						•		•	•	•					•						•		•	•	
Arancio - Orange	•	•			•	•	•						•		•	•	•					•						•		•	•	
Aavorio - Ivory	•	•	•	•	•	•	•	•	•	•	•	•	•	•	•	•	•	•	•	•	•	•	•	•	•	•	•	•	•	•	•	•
Azzurro - Azur	•		•	•	•	•	•						•		•	•	•					•						•		•	•	
Bianco azzurrato - White	•	•		•	•	•	•	•	•	•	•	•	•	•	•	•	•	•	•	•	•	•	•	•	•	•	•	•	•	•	•	•
Blu scuro - Dark blue	•				•	•	•						•		•	•	•					•						•		•	•	
Blu oltremare - Ultramarine blue	•				•	•	•						•		•	•	•					•						•		•	•	
Blu petrolio - Petroleum blue	•				•	•	•						•		•	•	•					•						•		•	•	
Fango - Mud	•				•	•	•	•				•		•		•	•			•		•						•		•	•	
Giallo ginestra - Broom yellow	•			•	•	•	•	•	•	•	•	•	•	•	•	•	•	•	•	•	•	•	•	•	•	•	•	•	•	•	•	•
Giallo traffico - Traffic yellow	•				•	•	•			•			•		•	•	•					•						•		•	•	
Grigio medio - Medium grey	•				•	•	•					•		•		•	•					•						•		•	•	
Grigio luce - Light grey	•	•		•	•	•	•	•	•	•	•	•	•	•	•	•	•	•	•	•	•	•	•	•	•	•	•	•	•	•	•	•
Grigio Londra - London grey	•				•	•	•						•		•	•	•					•						•		•	•	
Grigio traffico - Traffic grey	•				•	•	•						•		•	•	•					•						•		•	•	
Marrone cioccolato - Chocolate brown	•				•	•	•						•		•	•	•					•						•		•	•	
Moka	•				•	•	•						•		•	•	•					•						•		•	•	
Nero - Black	•				•	•	•						•		•	•	•					•						•		•	•	
Rosso carminio - Carmine red	•				•	•	•						•		•	•	•			•		•						•		•	•	
Rosso porpora - Purple red	•				•	•	•						•		•	•	•				•							•		•	•	
Rosso rubino - Ruby red	•				•	•	•						•		•	•	•					•						•		•	•	
Rosso ossido - Oxide red	•				•	•	•						•		•	•	•					•						•		•	•	
Sabbia - Sandy	•		•		•	•	•	•			•		•		•	•	•	•	•	•	•	•	•	•	•	•	•	•	•	•	•	•
Tortora - Dove	•				•	•	•						•		•	•	•					•						•		•	•	
Verde smeraldo - Emerald green	•				•	•	•						•		•	•	•					•						•		•	•	
Verde pallido - Pale green	•				•	•	•						•		•	•	•					•					•		•	•		
Verde chiaro - Light green	•				•	•	•						•		•	•	•					•					•		•	•		
Verde foresta - Forest green	•				•	•	•						•		•	•	•					•						•		•	•	
Verde mela - Apple green	•				•	•	•						•		•	•	•					•						•		•	•	
Verde felce - Fern green	•				•	•	•						•		•	•	•					•						•		•	•	
Viola traffico - Traffic violet	•				•	•	•						•		•	•	•					•						•		•	•	
Lilla - Liliac	•				•	•	•						•		•	•	•					•						•		•	•	•

COLORI - COLOURS

Antracite Anthracite	Simil RAL7024
Arancio Orange	SimilPANT 7577/C
Aavorio Ivory	Simil RAL 1013
Azzurro Azur	Simil PANT. 646/C
Bianco azzurrato White	Simil RAL 9016
Blu scuro Dark blue	Simil RAL 5008
Blu oltremare Ultramarine blue	RAL 5002
Blu petrolio Petroleum blue	PANT. 7477/C
Fango Mud	Simil PANT. 404/C
Giallo ginestra Broom yellow	RAL 1032
Giallo traffico Traffic yellow	RAL 1023
Grigio medio Medium grey	Simil PANT. 424/C
Grigio luce Light grey	RAL 7035
Grigio Londra London grey	Simil PANT. 418/C
Grigio traffico Traffic grey	Simil RAL 7042
Marrone cioccolato Chocolate brown	RAL 8017
Moka	Simil RAL 8019
Nero Black	RAL 9005
Rosso carminio Carmine red	RAL 3002
Rosso porpora Purple red	RAL 3004
Rosso rubino Ruby red	RAL 3003
Rosso ossido Oxide red	RAL 3009
Sabbia Sandy	Simil PANT. 7536/C
Tortora Dove	RAL 1019
Verde smeraldo Emerald green	RAL 6001
Verde pallido Pale green	RAL 6021
Verde chiaro Light green	RAL 6019
Verde foresta Forest green	PANT. 417/C
Verde mela Apple green	Simil PANT. 585/U
Verde felce Fern green	RAL 6025
Viola traffico Traffic violet	RAL 4006
Lilla Liliac	RAL 4005

NEXUS 4 LEGS

albacomponents

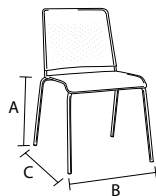

03 NEXUS-TELAIO 4 GAMBE CON SCOCCA IN LAMIERA

NEXUS-4 LEGS FRAME WITH SHELL METAL SHEET

CODICE/CODE	FINITURA/FINISHING	Q.KIT	Q.MIN/PACK	A	B	C	KG.x1/WT.x1	VOL.x1/UNIT VOL.
112603-070	■ NERO/BLACK	x1	50	450	530	540	9,80	mc. 0,04
112604-070	■ GRIGIO/GREY	x1	50	450	530	540	9,80	mc. 0,04
112605-070	□ BIANCO/WHITE RAL9010	x1	50	450	530	540	9,80	mc. 0,04
112607-070	■ CORTEN	x1	50	450	530	540	9,80	mc. 0,04

04 PUNTALE ALETTATO TONDO D.18 NERO

INNER CAP FOR LEGS D.18 BLACK

CODICE/CODE	FINITURA/FINISHING	Q.KIT	Q.MIN/PACK
137003-072	■ NERO/BLACK	x4	200

278

NEXUS

03 + 04



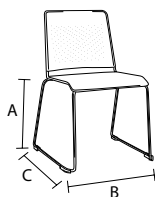
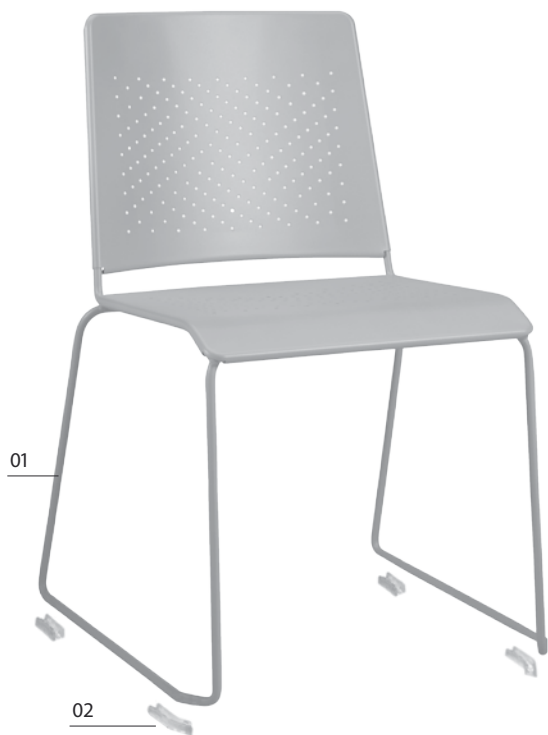

01 NEXUS-TELAIO SLITTA IN TONDINO CON SCOCCA IN LAMIERA
NEXUS-SLIDE WIRE FRAME WITH SHELL METAL SHEET

CODICE/CODE	FINITURA/FINISHING	Q. KIT	Q. MIN/PACK	A	B	C	KG.x1/WT.x1	VOL.x1/UNIT VOL.
113403-010	■ NERO/BLACK	x1	50	450	520	565	8,20	mc. 0,04
113404-010	■ GRIGIO/GREY	x1	50	450	520	565	8,20	mc. 0,04
113405-010	□ BIANCO/WHITE	x1	50	450	520	565	8,20	mc. 0,04
113407-010	■ CORTEN	x1	50	450	520	565	8,20	mc. 0,04

02 BTF-KIT PIEDINI
BTF-KIT FEET

CODICE/CODE	FINITURA/FINISHING	Q. KIT	Q. MIN/PACK	KG.x1/WT.x1
134306-001	□ NEUTRO/NEUTRAL	x1	100	0,05

OPTIONAL 02
BTF-KIT PIEDINI
BTF-KIT FEET



01 + 02
OPTIONAL

