



Designed by:
IVANO DALLA VAL



Certified

Square è la sedia perfetta per ogni tipo di utilizzo nell'ambito Office. L'ampia e confortevole seduta, unita all'elevato numero di opzioni e versioni di telai e componenti disponibili, la rendono l'opzione ideale per qualsiasi utilizzo. La certificazione CATAS garantisce alti livelli qualitativi e la rendono ideale per le situazioni Contract.

Square is the perfect chair for all kinds of use within the office. The wide and comfortable seat, combined with the large number of options and versions of frames and components available, make it the ideal option for any use. CATAS certification ensures high quality and make it ideal for contract environments.



albacomponents



CERTIFIED BY
CATAS
BIFMA



SQUARE

■ . inspired by ALBA

SLIDE

4 LEGS

4 LEGS FOR CASTORS

SWIVEL

BENCH



EN 13761

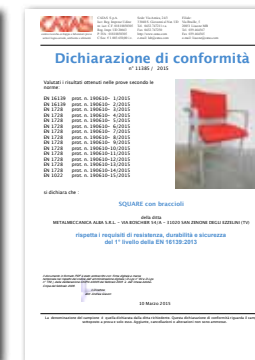

EN 16139



BIFMA TEST

SQUARE 4 LEGS

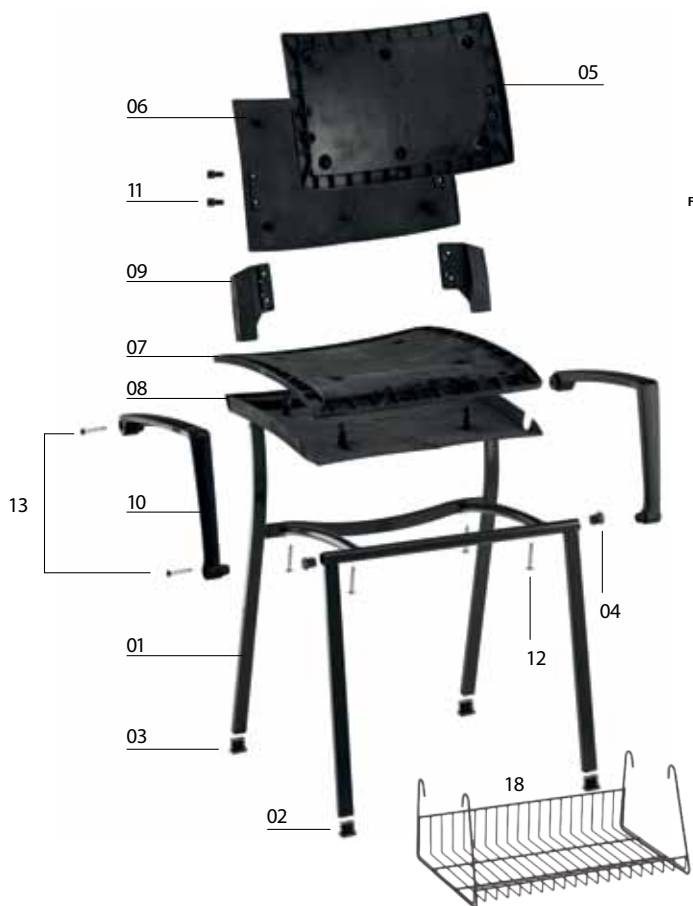
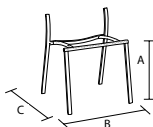

FORNITI NELLA STESSA CONFEZIONE
SUPPLIED IN THE SAME PACKAGE

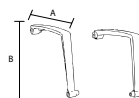
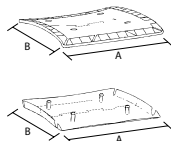
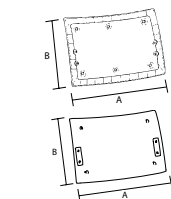

01 05 06 + 07 08 + 09 + 04 + 16 + 02 + 03

OPTIONAL



28 + 30 + 09

29 + 31 + 09

24 + 25 + 26

24

10 + 17

OPTIONAL

14

OPTIONAL

15

OPTIONAL

OPTIONAL



01 SQUARE-TELAIO PER SEDIA FISSA SENZA TAPPISOTTOPIEDE MONTATI SQUARE -FIXED FRAME FOR CHAIR WITHOUT CAPS										
CODICE/CODE	FINITURA/FINISHING	Q. KIT	Q. MIN/PACK	A	B	C	KG. x1/WT.x1	VOL. x1/UNIT VOL.		
112603-025	■ NERO/BLACK	x1	80	450	500	500	3,20	mc. 0,003		
112604-025	■ GRIGIO/GREY	x1	80	450	500	500	3,20	mc. 0,003		
112610-025	■ CROMATO/CHROME	x1	80	450	500	500	3,20	mc. 0,003		
02 CONFEZIONE PUNTALI RETTANGOLARI 25X15 BLACK INNER FLAT RECTANGULAR CAPS 25x15 PACKAGE										
CODICE/CODE	FINITURA/FINISHING	Q. KIT	Q. MIN/PACK							
137003-074	■ NERO/BLACK	x2	160							
134204-020	■ GRIGIO/GREY	x2								
03 CONFEZIONE PUNTALI INCLINATI RETTANGOLARI 25X15 BLACK INNER OBLIQUE RECTANGULAR CAPS 25x15 PACKAGE										
CODICE/CODE	FINITURA/FINISHING	Q. KIT								
137003-074	■ NERO/BLACK	x2	160							
134204-023	■ GRIGIO/GREY	x2								
04 TAPPO COPRITESTA Ø22 PER SEDIA SENZA BRACCIOLI COVER HEAD CAP Ø22 FOR CHAIR WITHOUT ARMS										
CODICE/CODE	FINITURA/FINISHING	Q. KIT								
134103-220	■ NERO/BLACK	x2								
134104-220	■ GRIGIO/GREY	x2								
05 SQUARE-SHI-SCHIENALE INTERNO IN PLASTICA SQUARE-SHI-INNER PLASTIC BACK										
CODICE/CODE	FINITURA/FINISHING	Q. KIT	Q. MIN/PACK	A	B	KG. x1/WT.x1	VOL. x1/UNIT VOL.			
132103-006	■ NERO/BLACK	x1	20	440	290	0,55	mc. 0,004			
06 SQUARE-SHE-SCHIENALE ESTERNO IN PLASTICA SQUARE-SHE-OUTER PLASTIC BACK										
CODICE/CODE	FINITURA/FINISHING	Q. KIT	Q. MIN/PACK	A	B	KG. x1/WT.x1	VOL. x1/UNIT VOL.			
132103-005	■ NERO/BLACK	x1	20	425	280	0,37	mc. 0,004			
132104-026	■ GRIGIO/GREY	x1	20	425	280	0,37	mc. 0,004			
07 SQUARE-SEDILE INTERNO IN PLASTICA SQUARE-INNER PLASTIC SEAT										
CODICE/CODE	FINITURA/FINISHING	Q. KIT	Q. MIN/PACK	A	B	KG. x1/WT.x1	VOL. x1/UNIT VOL.			
132203-007	■ NERO/BLACK	x1	20	440	460	0,90	mc. 0,005			
08 SQUARE-SEDILE ESTERNO IN PLASTICA SQUARE-OUTER PLASTIC SEAT										
CODICE/CODE	FINITURA/FINISHING	Q. KIT	Q. MIN/PACK	A	B	KG. x1/WT.x1	VOL. x1/UNIT VOL.			
132203-006	■ NERO/BLACK	x1	20	430	450	0,53	mc. 0,008			
132204-026	■ GRIGIO/GREY	x1	20	430	450	0,53	mc. 0,008			
09 SQUARE-COPPIA SUPPORTI SCHIENALE IN PLASTICA SQUARE-PLASTIC PAIR OF SUPPORTS FOR BACK										
CODICE/CODE	FINITURA/FINISHING	Q. KIT	Q. MIN/PACK	A	KG. x1/WT.x1	VOL. x1/UNIT VOL.				
134003-087	■ NERO/BLACK	x1	40	25x15	0,16	mc. 0,0002				
134004-022	■ GRIGIO/GREY	x1	40	25x15	0,16	mc. 0,0002				
10 SQUARE-COPPIA BRACCIOLI IN PLASTICA SQUARE-PLASTIC PAIR ARMS										
CODICE/CODE	FINITURA/FINISHING	Q. KIT	Q. MIN/PACK	A	B	KG. x1/WT.x1	VOL. x1/UNIT VOL.			
131703-005	■ NERO/BLACK	x1	10	360	260	0,70	mc. 0,006			
131704-005	■ GRIGIO/GREY	x1	10	360	260	0,70	mc. 0,006			
11 VITE TESTA CILINDRICA A CROCE M6X16 ZINCATA SCREW CYLINDRICAL CROSS HEAD M6X16 ZINC										
CODICE/CODE	FINITURA/FINISHING	Q. KIT								
117711-191	■ ZINCATA/ZINC	x4								
12 VITE TESTA SVASATA A CROCE M6X30 ZINCATA (VITE PER FISSAGGIO SEDILE) SCREW FLARED HEAD M6X30 ZINC (SCREW FOR SIX SEAT)										
CODICE/CODE	FINITURA/FINISHING	Q. KIT								
117711-192	■ ZINCATA/ZINC	x4								
13 VITE AUTOFILETTANTE 5,5X45 TESTA SVASATA A CROCE SCREW AUTO-THREADING 5,5X45 FLARED CROSS										
CODICE/CODE	FINITURA/FINISHING	Q. KIT								
117811-168	■ ZINCATA/ZINC	x4								
18 SQUARE-CESTELLO PORTARIVISTE SQUARE-BASKET TRAY										
CODICE/CODE	FINITURA/FINISHING	Q. KIT								
113403-003	■ NERO/BLACK	x1								

4 LEGS OPTIONS:



28	SCHIENALE IN MULTISTRATO FAGGIO BACK IN PLYWOOD BEECH	Q. KIT	Q. MIN/PACK	A	B	KG. x1/WT.x1
	CODICE/CODE FINITURA/FINISHING					
	122107-010 ■ FAGGIO/BEECH WOOD	x1	15	425	280	1,30

30	SQUARE SDLF-SEDILE MULTISTRATO FAGGIO VERNICIATO + VITI SQUARE SDLF-PAINTED BEECH WOOD SEAT WITH SCREWS	Q. KIT	Q. MIN/PACK	A	B	KG. x1/WT.x1
	CODICE/CODE FINITURA/FINISHING					
	122207-015 ■ FAGGIO/BEECH WOOD	x1	15	422	280	1,65



29	SCHIENALE TAPPEZZATO CUIOIO BLACK UPHOLTERED IN BLACK LEATHER	Q. KIT	Q. MIN/PACK	A	B	KG. x1/WT.x1
	CODICE/CODE FINITURA/FINISHING					
	142103-001 ■ CUIOIO/LEATHER	x1	15	430	450	1,05

31	SQUARE SDCNR-SEDILE TAPPEZZATO CUIOIO NERO + VITI SQUARE SDCNR-BLACK LEATHER SEAT WITH SCREWS	Q. KIT	Q. MIN/PACK	A	B	KG. x1/WT.x1
	CODICE/CODE FINITURA/FINISHING					
	142203-001 ■ CUIOIO/LEATHER	x1	15	422	280	1,36



24	SQUARE-COPPIA SEDILE SCHIENALE IN PLASTICA COLORATO SQUARE-PLASTIC SEAT/BACK COLOURED AT SIGHT	Q. KIT	Q. MIN/PACK	A	B	C	D	KG. x1/WT.x1	VOL. x1/UNIT VOL.
	CODICE/CODE FINITURA/FINISHING								
	134003-088 ■ NERO/BLACK	x1	10	450	440	500	300	1,62	mc. 0,012
	134004-023 ■ GRIGIO/GREY RAL7040	x1	10	450	440	500	300	1,62	mc. 0,012
	134002-023 ■ ROSSO/RED PPL42	x1	10	450	440	500	300	1,62	mc. 0,012
	134015-023 ■ BLU/BLUE RAL5002	x1	10	450	440	500	300	1,62	mc. 0,012
	134007-023 ■ ARANCIO/ORANGE PPL22	x1	10	450	440	500	300	1,62	mc. 0,012
	134005-023 ■ BEIGE/BEIGE PPL09	x1	10	450	440	500	300	1,62	mc. 0,012



25	PANNELLO SCHIENALE DA TAPPEZZARE PANEL BACK FOR UPHOLSTERY	Q. KIT	Q. MIN/PACK	A	B	KG. x1/WT.x1	VOL. x1/UNIT VOL.
	CODICE/CODE FINITURA/FINISHING						
	132103-046 ■ NERO/BLACK	x1	20	390	310	0,50	mc. 0,004

26	PANNELLO SEDILE DA TAPPEZZARE PANEL SEAT FOR UPHOLSTERY	Q. KIT	Q. MIN/PACK	A	B	KG. x1/WT.x1	VOL. x1/UNIT VOL.
	CODICE/CODE FINITURA/FINISHING						
	132203-046 ■ NERO/BLACK	x1	20	400	450	0,60	mc. 0,004

27	CONFEZIONE VITI TBL+ FR. D. 5X14 PER PANNELLO DA TAPPEZZARE SCREWS TBL+ FR.HILO D.5X14 ZINC.BLACK (TO FIX SEAT PANEL) PACKAGE	Q. KIT	Q. MIN/PACK
	CODICE/CODE FINITURA/FINISHING		
	117003-071 ■ NERO/BLACK	x4	200

OPTIONAL 14/15

BRACCIOLO DESTRO/SINISTRO CON GANCIO PORTATAVOLETTA
RIGHT/LEFT ARM WITH ATTACHMENT FOR TABLET



131703-009 DESTRO/RIGHT ■ NERO/BLACK
131703-006 SINISTRO/LEFT ■ NERO/BLACK
131704-003 DESTRO/RIGHT ■ GRIGIO/GREY
131704-004 SINISTRO/LEFT ■ GRIGIO/GREY

14	15	Q. KIT	Q. MIN/PACK	KG. x1/WT.x1	VOL. x1/UNIT VOL.
		x1	20	0,70	mc. 0,006

OPTIONAL 16/17/39

AGGANCIAMENTO LATERALE MASCHIO+FEMMINA IN PLASTICA + 2 VITI
PLASTIC LATERAL HOOK MALE+FEMALE AND 2 SCREWS
PER BRACCIOLO FOR ARM
PER BRACCIOLO CON PORTATAVOLETTA FOR ARM WITH ATTACHMENT FOR TABLET



134003-130 ■ NERO/BLACK 134003-131 ■ NERO/BLACK 134003-138 ■ NERO/BLACK

16	17	39	Q. KIT	Q. MIN/PACK	KG. x1/WT.x1	VOL. x1/UNIT VOL.
			x1	100	0,03	0,0001

OPTIONAL



VEDI/SEE PAG. 321 VEDI/SEE PAG. 321 VEDI/SEE PAG. 321 VEDI/SEE PAG. 321 VEDI/SEE PAG. 321 VEDI/SEE PAG. 320 VEDI/SEE PAG. 320

SQUARE 4 LEGS FOR CASTORS

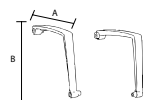
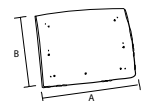
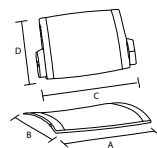
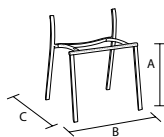

22 TELAIO PER SEDIA 4 GAMBE PREDISPOSTO PER 4 RUOTE + 4 TAPPI PORTA RUOTE

FRAME FOR CHAIR ISSUED FOR 4 WHEELS + 4 INNER BLACK CAPS FOR CASTORS

CODICE/CODE	FINITURA/FINISHING	Q. KIT	Q. MIN/PACK	A	B	C	KG. x1/WT.x1	VOL. x1/UNIT VOL.
112603-027	■ NERO/BLACK	x1	80	450	500	500	3,10	mc. 0,003
112604-027	■ GRIGIO/GREY	x1	80	450	500	500	3,10	mc. 0,003
112610-027	■ CROMATO/CHROME	x1	80	450	500	500	3,10	mc. 0,003

04 TAPPO COPRITESTA Ø22 PER SEDIA SENZA BRACCIOLI

COVER HEAD CAP Ø22 FOR CHAIR WITHOUT ARMS

CODICE/CODE	FINITURA/FINISHING	Q. KIT
134103-220	■ NERO/BLACK	x2
134104-220	■ GRIGIO/GREY	x2

24 SQUARE-COPPIA SEDILE SCHIENALE IN PLASTICA COLORATO

SQUARE-PLASTIC SEAT/BACK COLOURED AT SIGHT

CODICE/CODE	FINITURA/FINISHING	Q. KIT	Q. MIN/PACK	A	B	C	D	KG. x1/WT.x1	VOL. x1/UNIT VOL.
134003-088	■ NERO/BLACK	x1	10	450	440	500	300	1,62	mc. 0,012
134004-023	■ GRIGIO/GREY	x1	10	450	440	500	300	1,62	mc. 0,012
134002-023	■ ROSSO/RED	x1	10	450	440	500	300	1,62	mc. 0,012
134015-023	■ BLU/BLUE	x1	10	450	440	500	300	1,62	mc. 0,012
134007-023	■ ARANCIO/ORANGE	x1	10	450	440	500	300	1,62	mc. 0,012
134005-023	■ BEIGE/BEIGE	x1	10	450	440	500	300	1,62	mc. 0,012

25 PANNELLO SCHIENALE DA TAPPEZZARE

PANEL BACK FOR UPHOLSTERY

CODICE/CODE	FINITURA/FINISHING	Q. KIT	Q. MIN/PACK	A	B	KG. x1/WT.x1	VOL. x1/UNIT VOL.
132103-046	■ NERO/BLACK	x1	20	390	310	0,50	mc. 0,004

26 PANNELLO SEDILE DA TAPPEZZARE

PANEL SEAT FOR UPHOLSTERY

CODICE/CODE	FINITURA/FINISHING	Q. KIT	Q. MIN/PACK	A	B	KG. x1/WT.x1	VOL. x1/UNIT VOL.
132203-046	■ NERO/BLACK	x1	20	400	450	0,60	mc. 0,004

10 SQUARE-COPPIA BRACCIOLI IN PLASTICA

SQUARE-PLASTIC PAIR ARMS

CODICE/CODE	FINITURA/FINISHING	Q. KIT	Q. MIN/PACK	A	B	KG. x1/WT.x1	VOL. x1/UNIT VOL.
131703-005	■ NERO/BLACK	x1	10	360	260	0,70	mc. 0,006
131704-005	■ GRIGIO/GREY	x1	10	360	260	0,70	mc. 0,006

27 CONFEZIONE VITI TBL+ FR. D.5X14 PER PANNELLO DA TAPPEZZARE

SCREWS TBL+ FR.HILO D.5X14 ZINC, BLACK (TO FIX SEAT PANEL) PACKAGE

CODICE/CODE	FINITURA/FINISHING	Q. KIT	Q. MIN/PACK
117003-071	■ NERO/BLACK	x4	200

23 DOPPIA RUOTA Ø36 IN PA (RICOPERTA PUR)

PA TWIN WHEEL CASTOR Ø36 (COVERED WITH PUR)

CODICE/CODE	FINITURA/FINISHING	Q. KIT
134403-001	■ NERO/BLACK	x4

23 GAMBO GODRONATO Ø8 ZINCATO

ZINC PLATED KNURED Ø8 STEM

CODICE/CODE	FINITURA/FINISHING	Q. KIT
117911-300	■ ZINCATA/ZINC	x4

22 05 06 + 07 08 + 09 + 04 + 23

28 + 30 + 09

29 + 31 + 09

24 + 25 + 26

24

10

14

OPTIONAL

15

OPTIONAL



OPTIONAL 25/26/27

PANNELLO SCHIENALE E SEDILE DA TAPPEZZARE + VITE
PANEL BACK AND SEAT FOR UPHOLSTERY AND SCREW

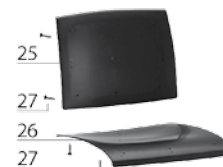

OPTIONAL 14/15

BRACCIOLO DESTRO/SINISTRO CON GANCIO PORTATAVOLETTA
RIGHT/LEFT ARM WITH ATTACHMENT FOR TABLET



131703-009 DESTRO/RIGHT	■ NERO/BLACK
131703-006 SINISTRO/LEFT	■ NERO/BLACK
131704-003 DESTRO/RIGHT	■ GRIGIO/GREY
131704-004 SINISTRO/LEFT	■ GRIGIO/GREY

14	15	Q. KIT	Q. MIN/PACK	KG. x1/WT.x1	VOL. x1/UNIT VOL.
		x1	20	0,70	mc. 0,006

4 LEGS FOR CASTORS OPTIONS:

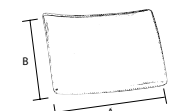
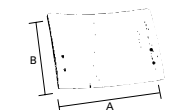
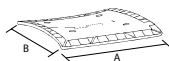
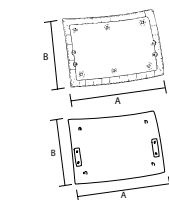

05	SQUARE-SHI-SCHIENALE INTERNO IN PLASTICA SQUARE-SHI-INNER PLASTIC BACK						
CODICE/CODE	FINITURA/FINISHING	Q. KIT	Q. MIN/PACK	A	B	KG. x1/WT.x1	VOL. x1/UNIT VOL.
132103-006	■ NERO/BLACK	x1	20	440	290	0,55	mc. 0,004

06	SQUARE-SHE-SCHIENALE ESTERNO IN PLASTICA SQUARE-SHE-OUTER PLASTIC BACK						
CODICE/CODE	FINITURA/FINISHING	Q. KIT	Q. MIN/PACK	A	B	KG. x1/WT.x1	VOL. x1/UNIT VOL.
132103-005	■ NERO/BLACK	x1	20	425	280	0,37	mc. 0,004
132104-026	■ GRIGIO/GREY	x1	20	425	280	0,37	mc. 0,004

07	SQUARE-SEBILE INTERNO IN PLASTICA SQUARE-INNER PLASTIC SEAT						
CODICE/CODE	FINITURA/FINISHING	Q. KIT	Q. MIN/PACK	A	B	KG. x1/WT.x1	VOL. x1/UNIT VOL.
132203-007	■ NERO/BLACK	x1	20	440	460	0,90	mc. 0,005

08	SQUARE-SEBILE ESTERNO IN PLASTICA SQUARE-OUTER PLASTIC SEAT						
CODICE/CODE	FINITURA/FINISHING	Q. KIT	Q. MIN/PACK	A	B	KG. x1/WT.x1	VOL. x1/UNIT VOL.
132203-006	■ NERO/BLACK	x1	20	430	450	0,53	mc. 0,008
132204-026	■ GRIGIO/GREY	x1	20	430	450	0,53	mc. 0,008

09	SQUARE-COPPIA SUPPORTI SCHIENALE IN PLASTICA SQUARE-PLASTIC PAIR OF SUPPORTS FOR BACK						
CODICE/CODE	FINITURA/FINISHING	Q. KIT	Q. MIN/PACK	A	KG. x1/WT.x1	VOL. x1/UNIT VOL.	
134003-087	■ NERO/BLACK	x1	40	25x15		0,16	mc. 0,0002
134004-022	■ GRIGIO/GREY	x1	40	25x15		0,16	mc. 0,0002

+ 11 + 12 + 13 VITI / SCREWS

28	SCHIENALE IN MULTISTRATO FAGGIO BACK IN PLYWOOD BEECH					
CODICE/CODE	FINITURA/FINISHING	Q. KIT	Q. MIN/PACK	A	B	KG. x1/WT.x1
122107-010	■ FAGGIO/BEECH WOOD	x1	15	425	280	1,30

30	SQUARE SDLF-SEBILE MULTISTRATO FAGGIO VERNICIATO + VITI SQUARE SDLF-PAINTED BEECH WOOD SEAT WITH SCREWS					
CODICE/CODE	FINITURA/FINISHING	Q. KIT	Q. MIN/PACK	A	B	KG. x1/WT.x1
122207-015	■ FAGGIO/BEECH WOOD	x1	15	422	280	1,65

29	SCHIENALE TAPPEZZATO CUOIO BLACK UPHOLTERED IN BLACK LEATHER					
CODICE/CODE	FINITURA/FINISHING	Q. KIT	Q. MIN/PACK	A	B	KG. x1/WT.x1
142103-001	■ CUOIO/LEATHER	x1	15	430	450	1,05

31	SQUARE SDCNR-SEBILE TAPPEZZATO CUOIO NERO + VITI SQUARE SDCNR-BLACK LEATHER SEAT WITH SCREWS					
CODICE/CODE	FINITURA/FINISHING	Q. KIT	Q. MIN/PACK	A	B	KG. x1/WT.x1
142203-001	■ CUOIO/LEATHER	x1	15	422	280	1,36

SQUARE-CARRELLO PORTASEDIE CON ACCESSORI SQUARE-TROLLEY FOR CHAIRS WITH ACCESSORIES	
CODICE/CODE	FINITURA/FINISHING
112603-039	NERO/BLACK

SQUARE SLIDE

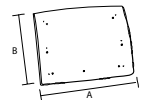
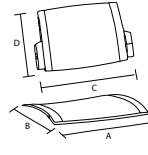

35 BASE SLITTA SLIDE BASES									
CODICE/CODE	FINITURA/FINISHING	Q. KIT	Q. MIN/PACK	A	B	KG. x1/WT.x1	VOL. x1/UNIT VOL.		
110503-013	■ NERO/BLACK	x1	80	450		6,50	mc. 0,03		
110504-017	■ GRIGIO/GREY	x1	80	450		6,50	mc. 0,03		
110510-016	■ CROMATO/CHROME	x1	80	450		6,50	mc. 0,03		
36 P2P PINZA DUE PIOLI POLITENE NERA P2P TWO-PINS PLIER IN BLACK POLYTHENE									
CODICE/CODE	FINITURA/FINISHING	Q. KIT							
134003-003	■ NERO/BLACK	x4							
37 TAPPO COPRITESTA ALETTATO D.25 NERO RIBBED INSERT D.25 BLACK									
CODICE/CODE	FINITURA/FINISHING	Q. KIT							
134103-250	■ NERO/BLACK	x2							
38 PIEDINO ANTIRIBALTAMENTO IN PLASTICA NERO PLASTIC BLACK FEET ANTI-UPSETTING									
CODICE/CODE	FINITURA/FINISHING	Q. KIT	Q. MIN/PACK	A	B	KG. x1/WT.x1	VOL. x1/UNIT VOL.		
134303-006	■ NERO/BLACK	x2	100			0,025	mc. 0,0001		
24 SQUARE-COPPIA SEDILE SCHIENALE IN PLASTICA COLORATO SQUARE-PLASTIC SEAT/BACK COLOURED AT SIGHT									
CODICE/CODE	FINITURA/FINISHING	Q. KIT	Q. MIN/PACK	A	B	C	D	KG. x1/WT.x1	VOL. x1/UNIT VOL.
134003-088	■ NERO/BLACK	x1	10	450	440	500	300	1,62	mc. 0,012
134004-023	■ GRIGIO/GREY RAL7040	x1	10	450	440	500	300	1,62	mc. 0,012
134002-023	■ ROSSO/RED PPL42	x1	10	450	440	500	300	1,62	mc. 0,012
134015-023	■ BLU/BLUE RAL5002	x1	10	450	440	500	300	1,62	mc. 0,012
134007-023	■ ARANCIO/ORANGE PPL22	x1	10	450	440	500	300	1,62	mc. 0,012
134005-023	■ BEIGE/BEIGE PPL09	x1	10	450	440	500	300	1,62	mc. 0,012
25 PANNELLO SCHIENALE DA TAPPEZZARE PANEL BACK FOR UPHOLSTERY									
CODICE/CODE	FINITURA/FINISHING	Q. KIT	Q. MIN/PACK	A	B	KG. x1/WT.x1	VOL. x1/UNIT VOL.		
132103-046	■ NERO/BLACK	x1	20	390	310	0,50	mc. 0,004		
26 PANNELLO SEDILE DA TAPPEZZARE PANEL SEAT FOR UPHOLSTERY									
CODICE/CODE	FINITURA/FINISHING	Q. KIT	Q. MIN/PACK	A	B	KG. x1/WT.x1	VOL. x1/UNIT VOL.		
132203-046	■ NERO/BLACK	x1	20	400	450	0,60	mc. 0,004		
27 CONFEZIONE VITI TBL+ FR. D.5X14 PER PANNELLO DA TAPPEZZARE SCREWS TBL+ FR.HILO D.5X14 ZINC.BLACK (TO FIX SEAT PANEL) PACKAGE									
CODICE/CODE	FINITURA/FINISHING	Q. KIT	Q. MIN/PACK						
117003-071	■ NERO/BLACK	x4	200						
02 PUNTALE ALETTATO RETTANGOLARE 25X15 RIBBED RECTANGULAR INSERT 25X15									
CODICE/CODE	FINITURA/FINISHING	Q. KIT							
134203-020	■ NERO/BLACK	x2							
134204-020	■ GRIGIO/GREY	x2							
04 TAPPO COPRITESTA Ø22 PER SEDIA SENZA BRACCIOLI COVER HEAD CAP Ø22 FOR CHAIR WITHOUT ARMS									
CODICE/CODE	FINITURA/FINISHING	Q. KIT							
134103-220	■ NERO/BLACK	x2							
134104-220	■ GRIGIO/GREY	x2							
10 SQUARE-COPPIA BRACCIOLI IN PLASTICA SQUARE-PLASTIC PAIR ARMS									
CODICE/CODE	FINITURA/FINISHING	Q. KIT	Q. MIN/PACK	A	B	KG. x1/WT.x1	VOL. x1/UNIT VOL.		
131703-005	■ NERO/BLACK	x1	10	360	260	0,70	mc. 0,006		
131704-005	■ GRIGIO/GREY	x1	10	360	260	0,70	mc. 0,006		

35 05 06 + 07 08 + 09 + 04 + 02 + 36 + 37 + 38
OPTIONAL

28 + 30 + 09
29 + 31 + 09
24 + 25 + 26 + 10
24



OPTIONAL 38
PIEDINO ANTIRIBALTAMENTO
FEET ANTI-UPSETTING



OPTIONAL 25/26/27
PANNELLO SCHIENALE E SEDILE DA TAPPEZZARE + VITE
PANEL BACK AND SEAT FOR UPHOLSTERY AND SCREW



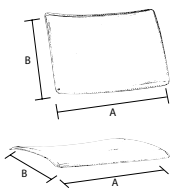
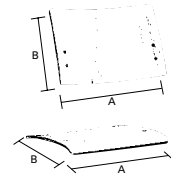
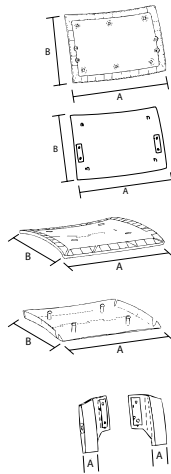

05 SQUARE-SHI-SCHIENALE INTERNO IN PLASTICA							
SQUARE-SHI-INNER PLASTIC BACK							
CODICE/CODE	FINITURA/FINISHING	Q. KIT	Q. MIN/PACK	A	B	KG. x1/WT.x1	VOL. x1/UNIT VOL.
132103-006	■ NERO/BLACK	x1	20	440	290	0,55	mc. 0,004

06 SQUARE-SHE-SCHIENALE ESTERNO IN PLASTICA							
SQUARE-SHE-OUTER PLASTIC BACK							
CODICE/CODE	FINITURA/FINISHING	Q. KIT	Q. MIN/PACK	A	B	KG. x1/WT.x1	VOL. x1/UNIT VOL.
132103-005	■ NERO/BLACK	x1	20	425	280	0,37	mc. 0,004
132104-026	■ GRIGIO/GREY	x1	20	425	280	0,37	mc. 0,004

07 SQUARE-SEDILO INTERNO IN PLASTICA							
SQUARE-INNER PLASTIC SEAT							
CODICE/CODE	FINITURA/FINISHING	Q. KIT	Q. MIN/PACK	A	B	KG. x1/WT.x1	VOL. x1/UNIT VOL.
132203-007	■ NERO/BLACK	x1	20	440	460	0,90	mc. 0,005

08 SQUARE-SEDILO ESTERNO IN PLASTICA							
SQUARE-OUTER PLASTIC SEAT							
CODICE/CODE	FINITURA/FINISHING	Q. KIT	Q. MIN/PACK	A	B	KG. x1/WT.x1	VOL. x1/UNIT VOL.
132203-008	■ NERO/BLACK	x1	20	430	450	0,53	mc. 0,008
132204-027	■ GRIGIO/GREY	x1	20	430	450	0,53	mc. 0,008

09 SQUARE-COPPIA SUPPORTI SCHIENALE IN PLASTICA							
SQUARE-PLASTIC PAIR OF SUPPORTS FOR BACK							
CODICE/CODE	FINITURA/FINISHING	Q. KIT	Q. MIN/PACK	A	B	KG. x1/WT.x1	VOL. x1/UNIT VOL.
134003-087	■ NERO/BLACK	x1	40	25x15		0,16	mc. 0,0002
134004-022	■ GRIGIO/GREY	x1	40	25x15		0,16	mc. 0,0002

+ 11 + 12 + 13 VITI / SCREWS

28 SCHIENALE IN MULTISTRATO FAGGIO							
BACK IN PLYWOOD BEECH							
CODICE/CODE	FINITURA/FINISHING	Q. KIT	Q. MIN/PACK	A	B	KG. x1/WT.x1	VOL. x1/UNIT VOL.
122107-010	■ FAGGIO/BEECH WOOD	x1	15	425	280	1,30	

30 SQUARE SDLF-SEDILO MULTISTRATO FAGGIO VERNICIATO + VITI							
SQUARE SDLF-PAINTED BEECH WOOD SEAT WITH SCREWS							
CODICE/CODE	FINITURA/FINISHING	Q. KIT	Q. MIN/PACK	A	B	KG. x1/WT.x1	VOL. x1/UNIT VOL.
122207-015	■ FAGGIO/BEECH WOOD	x1	15	422	280	1,65	

29 SCHIENALE TAPPEZZATO CUOIO							
BLACK UPHOLTERED IN BLACK LEATHER							
CODICE/CODE	FINITURA/FINISHING	Q. KIT	Q. MIN/PACK	A	B	KG. x1/WT.x1	VOL. x1/UNIT VOL.
142103-001	■ CUOIO/LEATHER	x1	15	430	450	1,05	

31 SQUARE SDCNR-SEDILO TAPPEZZATO CUOIO NERO + VITI							
SQUARE SDCNR-BLACK LEATHER SEAT WITH SCREWS							
CODICE/CODE	FINITURA/FINISHING	Q. KIT	Q. MIN/PACK	A	B	KG. x1/WT.x1	VOL. x1/UNIT VOL.
142203-001	■ CUOIO/LEATHER	x1	15	422	280	1,36	

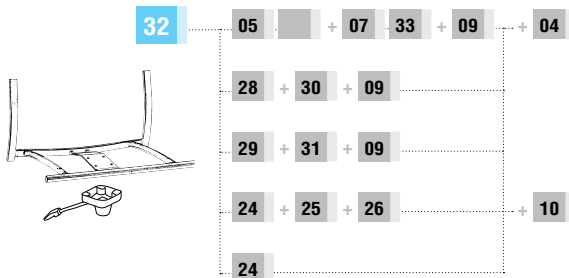
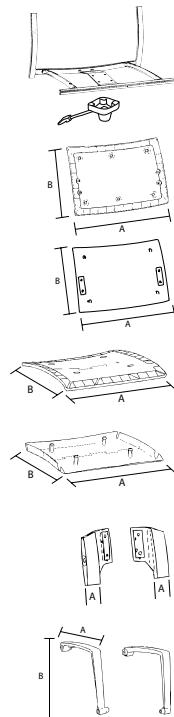

32	TELAIO GIREVOLE CON BLOCCHETTO COMANDO A GAS SWIVEL FRAME GAS WITH LEVER						
CODICE/CODE	FINITURA/FINISHING	Q. KIT	Q. MIN/PACK		KG. x1/WT.x1	VOL. x1/UNIT VOL.	
112603-029	■ NERO/BLACK	x1	100		3,50	mc. 0,05	
112604-029	■ GRIGIO/GREY	x1	100		3,50	mc. 0,05	
05	SQUARE-SHI-SCHIENALE INTERNO IN PLASTICA SQUARE-SHI-INNER PLASTIC BACK						
CODICE/CODE	FINITURA/FINISHING	Q. KIT	Q. MIN/PACK	A	B	KG. x1/WT.x1	VOL. x1/UNIT VOL.
132103-006	■ NERO/BLACK	x1	20	440	290	0,55	mc. 0,004
06	SQUARE-SHE-SCHIENALE ESTERNO IN PLASTICA SQUARE-SHE-OUTER PLASTIC BACK						
CODICE/CODE	FINITURA/FINISHING	Q. KIT	Q. MIN/PACK	A	B	KG. x1/WT.x1	VOL. x1/UNIT VOL.
132103-005	■ NERO/BLACK	x1	20	425	280	0,37	mc. 0,004
132104-026	■ GRIGIO/GREY	x1	20	425	280	0,37	mc. 0,004
07	SQUARE-SEDILE INTERNO IN PLASTICA SQUARE-INNER PLASTIC SEAT						
CODICE/CODE	FINITURA/FINISHING	Q. KIT	Q. MIN/PACK	A	B	KG. x1/WT.x1	VOL. x1/UNIT VOL.
132203-007	■ NERO/BLACK	x1	20	440	460	0,90	mc. 0,005
33	SQUARE-SEDILE ESTERNO IN PLASTICA SQUARE-OUTER PLASTIC SEAT						
CODICE/CODE	FINITURA/FINISHING	Q. KIT	Q. MIN/PACK	A	B	KG. x1/WT.x1	VOL. x1/UNIT VOL.
132203-008	■ NERO/BLACK	x1	20	430	450	0,53	mc. 0,008
132204-027	■ GRIGIO/GREY	x1	20	430	450	0,53	mc. 0,008
09	SQUARE-COPPIA SUPPORTI SCHIENALE IN PLASTICA SQUARE-PLASTIC PAIR OF SUPPORTS FOR BACK						
CODICE/CODE	FINITURA/FINISHING	Q. KIT	Q. MIN/PACK	A		KG. x1/WT.x1	VOL. x1/UNIT VOL.
134003-087	■ NERO/BLACK	x1	40	25x15		0,16	mc. 0,0002
134004-022	■ GRIGIO/GREY	x1	40	25x15		0,16	mc. 0,0002
10	SQUARE-COPPIA BRACCIOLI IN PLASTICA SQUARE-PLASTIC PAIR ARMS						
CODICE/CODE	FINITURA/FINISHING	Q. KIT	Q. MIN/PACK	A	B	KG. x1/WT.x1	VOL. x1/UNIT VOL.
131703-005	■ NERO/BLACK	x1	10	360	260	0,70	mc. 0,006
131704-005	■ GRIGIO/GREY	x1	10	360	260	0,70	mc. 0,006
11	VITE TESTA CILINDRICA A CROCE M6X16 ZINCATA SCREW CYLINDRICAL CROSS HEAD M6X16 ZINC						
CODICE/CODE	FINITURA/FINISHING	Q. KIT					
117711-191	■ ZINCATA/ZINC	x4					
12	VITE TESTA SVASATA A CROCE M6X30 ZINCATA (VITE PER FISSAGGIO SEDILE) SCREW FLARED HEAD M6X30 ZINC (SCREW FOR SIX SEAT)						
CODICE/CODE	FINITURA/FINISHING	Q. KIT					
117711-192	■ ZINCATA/ZINC	x4					
02	PUNTALE ALETTATO RETTANGOLARE 25X15 RIBBED RECTANGULAR INSERT 25X15						
CODICE/CODE	FINITURA/FINISHING	Q. KIT					
134203-020	■ NERO/BLACK	x2					
134204-020	■ GRIGIO/GREY	x2					
04	TAPPO COPRITESTA Ø22 PER SEDIA SENZA BRACCIOLI COVER HEAD CAP Ø22 FOR CHAIR WITHOUT ARMS						
CODICE/CODE	FINITURA/FINISHING	Q. KIT					
134103-220	■ NERO/BLACK	x2					
134104-220	■ GRIGIO/GREY	x2					

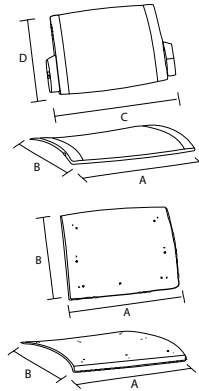

24 SQUARE-COPPIA SEDILE SCHIENALE IN PLASTICA COLORATO										
SQUARE-PLASTIC SEAT/BACK COLOURED AT SIGHT										
CODICE/CODE	FINITURA/FINISHING		Q. KIT	Q. MIN/PACK	A	B	C	D	KG. x1/WT.x1	VOL. x1/UNIT VOL.
134003-088	■ NERO/BLACK		x1	10	450	440	500	300	1,62	mc. 0,012
134004-023	■ GRIGIO/GREY	RAL7040	x1	10	450	440	500	300	1,62	mc. 0,012
134002-023	■ ROSSO/RED	PPL42	x1	10	450	440	500	300	1,62	mc. 0,012
134015-023	■ BLU/BLUE	RAL5002	x1	10	450	440	500	300	1,62	mc. 0,012
134007-023	■ ARANCIO/ORANGE	PPL22	x1	10	450	440	500	300	1,62	mc. 0,012
134005-023	■ BEIGE/BEIGE	PPL09	x1	10	450	440	500	300	1,62	mc. 0,012

25 PANNELLO SCHIENALE DA TAPPEZZARE										
PANEL BACK FOR UPHOLSTERY										
CODICE/CODE	FINITURA/FINISHING		Q. KIT	Q. MIN/PACK	A	B			KG. x1/WT.x1	VOL. x1/UNIT VOL.
132103-046	■ NERO/BLACK		x1	20	390	310			0,50	mc. 0,004

26 PANNELLO SEDILE DA TAPPEZZARE										
PANEL SEAT FOR UPHOLSTERY										
CODICE/CODE	FINITURA/FINISHING		Q. KIT	Q. MIN/PACK	A	B			KG. x1/WT.x1	VOL. x1/UNIT VOL.
132203-046	■ NERO/BLACK		x1	20	400	450			0,60	mc. 0,004

27 CONFEZIONE VITI TBL+ FR. D.5X14 PER PANNELLO DA TAPPEZZARE										
SCREWS TBL+ FR.HILO D.5X14 ZINC.BLACK (TO FIX SEAT PANEL) PACKAGE										
CODICE/CODE	FINITURA/FINISHING		Q. KIT	Q. MIN/PACK						
117003-071	■ NERO/BLACK		x4	200						

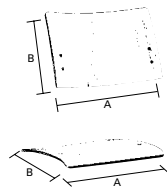

28 SCHIENALE IN MULTISTRATO FAGGIO										
BACK IN PLYWOOD BEECH										
CODICE/CODE	FINITURA/FINISHING		Q. KIT	Q. MIN/PACK	A	B			KG. x1/WT.x1	
122107-010	■ FAGGIO/BEECH WOOD		x1	15	425	280			1,30	

30 SQUARE SDF-SEDILE MULTISTRATO FAGGIO VERNICIATO + VITI										
SQUARE SDF-PAINTED BEECH WOOD SEAT WITH SCREWS										
CODICE/CODE	FINITURA/FINISHING		Q. KIT	Q. MIN/PACK	A	B			KG. x1/WT.x1	
122207-015	■ FAGGIO/BEECH WOOD		x1	15	422	280			1,65	

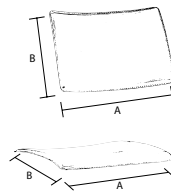

29 SCHIENALE TAPPEZZATO CUOIO										
BLACK UPHOLTERED IN BLACK LEATHER										
CODICE/CODE	FINITURA/FINISHING		Q. KIT	Q. MIN/PACK	A	B			KG. x1/WT.x1	
142103-001	■ CUOIO/LEATHER		x1	15	430	450			1,05	

31 SQUARE SDCNR-SEDILE TAPPEZZATO CUOIO NERO + VITI										
SQUARE SDCNR-BLACK LEATHER SEAT WITH SCREWS										
CODICE/CODE	FINITURA/FINISHING		Q. KIT	Q. MIN/PACK	A	B			KG. x1/WT.x1	
142203-001	■ CUOIO/LEATHER		x1	15	422	280			1,36	

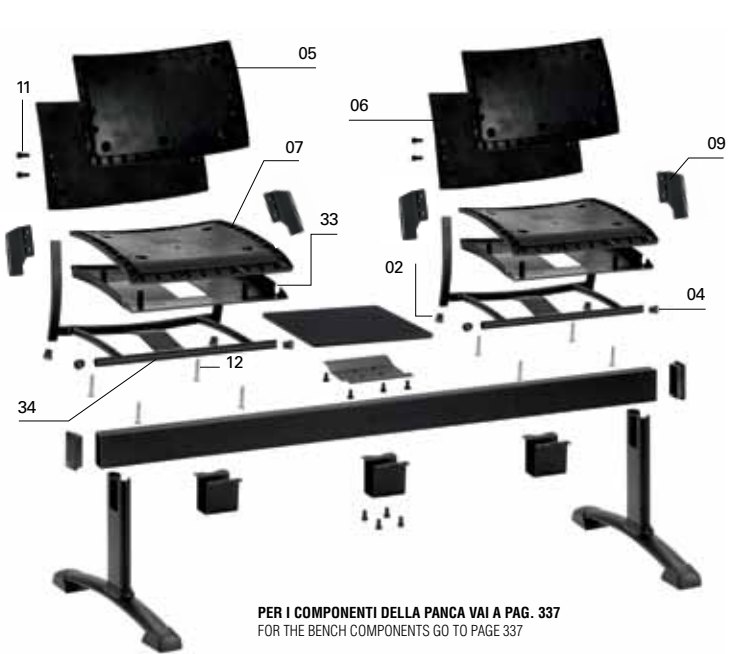

PER I COMPONENTI DELLA PANCA VAI A PAG. 337
FOR THE BENCH COMPONENTS GO TO PAGE 337

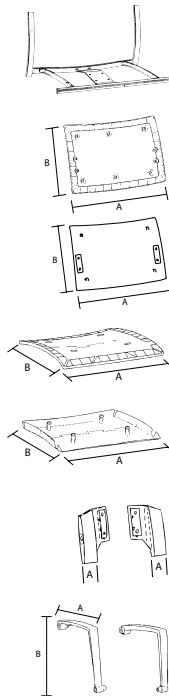

34	SQUARE-P TELAIO PER PANCA TAPPI ESCLUSI SQUARE-P BENCH FRAME CAPS EXCLUDED	Q. KIT	Q. MIN/PACK	KG. x1/WT.x1	VOL. x1/UNIT VOL.
CODICE/CODE	FINITURA/FINISHING				
110703-050	■ NERO/BLACK	x1	100	2,80	mc. 0,020
110704-063	■ GRIGIO/GREY	x1	100	2,80	mc. 0,020
05	SQUARE-SHI-SCHIENALE INTERNO IN PLASTICA SQUARE-SHI-INNER PLASTIC BACK	Q. KIT	Q. MIN/PACK	A	B
CODICE/CODE	FINITURA/FINISHING				
132103-006	■ NERO/BLACK	x1	20	440	290
06	SQUARE-SHE-SCHIENALE ESTERNO IN PLASTICA SQUARE-SHE-OUTER PLASTIC BACK	Q. KIT	Q. MIN/PACK	A	B
CODICE/CODE	FINITURA/FINISHING				
132103-005	■ NERO/BLACK	x1	20	425	280
132104-026	■ GRIGIO/GREY	x1	20	425	280
07	SQUARE-SEDILO INTERNO IN PLASTICA SQUARE-INNER PLASTIC SEAT	Q. KIT	Q. MIN/PACK	A	B
CODICE/CODE	FINITURA/FINISHING				
132203-007	■ NERO/BLACK	x1	20	440	460
33	SQUARE-SEDILO ESTERNO IN PLASTICA SQUARE-OUTER PLASTIC SEAT	Q. KIT	Q. MIN/PACK	A	B
CODICE/CODE	FINITURA/FINISHING				
132203-008	■ NERO/BLACK	x1	20	430	450
132204-027	■ GRIGIO/GREY	x1	20	430	450
09	SQUARE-COPPIA SUPPORTI SCHIENALE IN PLASTICA SQUARE-PLASTIC PAIR OF SUPPORTS FOR BACK	Q. KIT	Q. MIN/PACK	A	
CODICE/CODE	FINITURA/FINISHING				
134003-087	■ NERO/BLACK	x1	40	25x15	0,16
134004-022	■ GRIGIO/GREY	x1	40	25x15	0,16
10	SQUARE-COPPIA BRACCIOLI IN PLASTICA SQUARE-PLASTIC PAIR ARMS	Q. KIT	Q. MIN/PACK	A	B
CODICE/CODE	FINITURA/FINISHING				
131703-005	■ NERO/BLACK	x1	10	360	260
131704-005	■ GRIGIO/GREY	x1	10	360	260
11	VITE TESTA CILINDRICA A CROCE M6X16 ZINCATA SCREW CYLINDRICAL CROSS HEAD M6X16 ZINC	Q. KIT			
CODICE/CODE	FINITURA/FINISHING				
117711-191	■ ZINCATA/ZINC	x4			
12	VITE TESTA SVASATA A CROCE M6X30 ZINCATA (VITE PER FISSAGGIO SEDILE) SCREW FLARED HEAD M6X30 ZINC (SCREW FOR SIX SEAT)	Q. KIT			
CODICE/CODE	FINITURA/FINISHING				
117711-192	■ ZINCATA/ZINC	x4			
02	PUNTALE ALETTATO RETTANGOLARE 25X15 RIBBED RECTANGULAR INSERT 25X15	Q. KIT			
CODICE/CODE	FINITURA/FINISHING				
134203-020	■ NERO/BLACK	x2			
134204-020	■ GRIGIO/GREY	x2			
04	TAPPO COPRITESTA Ø22 PER SEDIA SENZA BRACCIOLI COVER HEAD CAP Ø22 FOR CHAIR WITHOUT ARMS	Q. KIT			
CODICE/CODE	FINITURA/FINISHING				
134103-220	■ NERO/BLACK	x2			
134104-220	■ GRIGIO/GREY	x2			

34 + 05 + 06 + 07 + 33 + 09 + 04

28 + 30 + 09 + 10

29 + 31 + 09

24 + 25 + 26

24



OPTIONAL PANCA
BENCH OPTIONAL



OPTIONAL CONNETTORE PANCA
OPTIONAL BENCH CONNECTOR



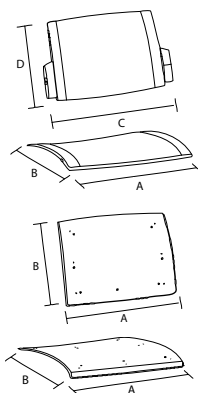

24 SQUARE-COPPIA SEDILE SCHIENALE IN PLASTICA COLORATO SQUARE-PLASTIC SEAT/BACK COLOURED AT SIGHT									
CODICE/CODE	FINITURA/FINISHING	Q. KIT	Q. MIN/PACK	A	B	C	D	KG. x1/WT.x1	VOL. x1/UNIT VOL.
134003-088	■ NERO/BLACK	x1	10	450	440	500	300	1,62	mc. 0,012
134004-023	■ GRIGIO/GREY RAL7040	x1	10	450	440	500	300	1,62	mc. 0,012
134002-023	■ ROSSO/RED	x1	10	450	440	500	300	1,62	mc. 0,012
134015-023	■ BLU/BLUE RAL5002	x1	10	450	440	500	300	1,62	mc. 0,012
134007-023	■ ARANCIO/ORANGE	x1	10	450	440	500	300	1,62	mc. 0,012
134005-023	■ BEIGE/BEIGE PPL09	x1	10	450	440	500	300	1,62	mc. 0,012

25 PANNELLO SCHIENALE DA TAPPEZZARE PANEL BACK FOR UPHOLSTERY									
CODICE/CODE	FINITURA/FINISHING	Q. KIT	Q. MIN/PACK	A	B	KG. x1/WT.x1	VOL. x1/UNIT VOL.		
132103-046	■ NERO/BLACK	x1	20	390	310	0,50	mc. 0,004		

26 PANNELLO SEDILE DA TAPPEZZARE PANEL SEAT FOR UPHOLSTERY									
CODICE/CODE	FINITURA/FINISHING	Q. KIT	Q. MIN/PACK	A	B	KG. x1/WT.x1	VOL. x1/UNIT VOL.		
132203-046	■ NERO/BLACK	x1	20	400	450	0,60	mc. 0,004		

27 CONFEZIONE VITI TBL+ FR. D. 5X14 PER PANNELLO DA TAPPEZZARE SCREWS TBL+ FR.HILO D.5X14 ZINC.BLACK (TO FIX SEAT PANEL) PACKAGE									
CODICE/CODE	FINITURA/FINISHING	Q. KIT	Q. MIN/PACK						
117003-071	■ NERO/BLACK	x4	200						

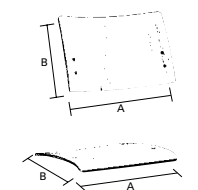
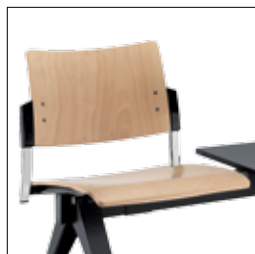

28 SCHIENALE IN MULTISTRATO FAGGIO BACK IN PLYWOOD BEECH									
CODICE/CODE	FINITURA/FINISHING	Q. KIT	Q. MIN/PACK	A	B	KG. x1/WT.x1			
122107-010	■ FAGGIO/BEECH WOOD	x1	15	425	280	1,30			

30 SQUARE SDF-SEDILE MULTISTRATO FAGGIO VERNICIATO + VITI SQUARE SDF-PAINTED BEECH WOOD SEAT WITH SCREWS									
CODICE/CODE	FINITURA/FINISHING	Q. KIT	Q. MIN/PACK	A	B	KG. x1/WT.x1			
122207-015	■ FAGGIO/BEECH WOOD	x1	15	422	280	1,65			

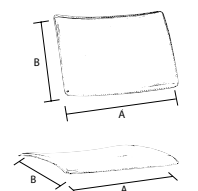

29 SCHIENALE TAPPEZZATO CUOIO BLACK UPHOLTERED IN BLACK LEATHER									
CODICE/CODE	FINITURA/FINISHING	Q. KIT	Q. MIN/PACK	A	B	KG. x1/WT.x1			
142103-001	■ CUOIO/LEATHER	x1	15	430	450	1,05			

31 SQUARE SDCNR-SEDILE TAPPEZZATO CUOIO NERO + VITI SQUARE SDCNR-BLACK LEATHER SEAT WITH SCREWS									
CODICE/CODE	FINITURA/FINISHING	Q. KIT	Q. MIN/PACK	A	B	KG. x1/WT.x1			
142203-001	■ CUOIO/LEATHER	x1	15	422	280	1,36			